

TRANSPORTATION MARKINGS: A STUDY IN

COMMUNICATION MONOGRAPH SERIES

VOLUME II FURTHER STUDIES IN

TRANSPORTATION MARKINGS

PART G

INTERNATIONAL AERONAUTICAL NAVIGATION AIDS

Brian Clearman

Mount Angel Abbey

1994

Dedicated to the Memory of
LDC, 1928-1992

Copyright (c) 1994 by Mount Angel Abbey
at Saint Benedict, Oregon 97373
All Rights Reserved

Library of Congress Cataloging-in-Publication Data

Clearman, Brian.
International aeronautical navigation aids / Brian Clearman.
p. cm. -- (Transportation markings ; v. 2) (Further studies
in transportation markings ; pt. G)
Includes bibliographical references (p.) and indexes.
ISBN 0-918941-08-3
1. Airports--Traffic control--Display systems. 2. Traffic signs
and signals. 3. Aids to air navigation. I. Title. II. Series:
Clearman, Brian. Transportation markings ; v. 2. III. Series:
Clearman, Brian. Further studies in transportation markings ; pt.
G.
TA1245.C56 1984 vol. 2, pt. G
[TL725.3.S47]
629'.042 s--dc20
[629.13] 94-14657
CIP

Note: the LC # preassigned to this monograph is different
than the one printed in the CIP data sheet. The preassigned
is 94-076173

TABLE OF CONTENTS

Preface	vii
Acknowledgments	viii
Abbreviations	x
33 AERONAUTICAL NAVIGATION AIDS: INTRODUCTION & EARLY DEVELOPMENTS	
A Introduction	
1 Terminology, The Nature of Aero Transportation Markings & Methodological Concerns	1
2 Aeronautical Nav Aids: Physical Properties & Semiotics	9
B History of Aero Nav Aids	
1 Introduction & Early Aviation Developments	16
2 Early History of Aero Aids, 1919-1937.	20
3 Development of Aero Aids, 1938-1943.	32
4 Final Developments Before ICAO, 1944-1950.	37
34 THE CLASSIFICATION	
A Main Classification	
1 Introduction	49
2 Main Classification.	51
3 Explanatory Notes	54
B Variant Classification	
1 Classification.	60
2 Explanatory Notes	63
C Pictorial Representations	
1 Illustrations	72
2 Explanatory Notes	78

35 LIGHTED AERO NAVIGATION AIDS

A	Approach Lighting	
1	Introduction	85
2	Equipment.	87
3	Messages	89
B	Final Approach Lighting	
1	Introduction	92
2	Messages	93
3	Equipment.	99
C	Runway & Taxiway Lighting	
1	Background, Terminology & Functions.	101
2	Inset Lights	102
3	Elevated Lights	105
4	Messages for Inset & Elevated Lights	107
D	Beacons & Obstruction Lighting	
1	Introduction	112
2	Beacons	113
3	Obstruction Lights	115
4	Messages for Beacons & Obstruction Lights	118

36 PARTIALLY-LIGHTED & UNLIGHTED AERO NAVIGATION AIDS

A.	Signs & Markings	
1	Introduction to Chapter 36	121
2	Signs: Types & Messages	123
3	Markings: Types & Messages	124
B	Indicators, Markers, Obstruction Markings & Restricted Use Markings	
1	Indicators: Types & Messages	129
2	Markers: Types & Messages.	130
3	Obstruction Markings: Types & Messages	134
4	Restricted Use Area Visual Aids	136

37 AERO ELECTRONIC NAVIGATION AIDS

A	Fully Integrated Systems	
1	Chapter 37: Overview & Changes	139
2	Instrument Landing Systems	142
3	Microwave Landing Systems	145
B	Independent & Partially Integrated Aids	
1	VOR, TACAN, VORTAC & DME.	148
2	Beacons & Multi-mode Radio Aids.	151

APPENDIX: COMPARATIVE REVIEW OF ICAO AERO NAV AIDS, 1949-1991.	159
---	-----

BIBLIOGRAPHY	169
------------------------	-----

INDICES:

i	General Index	191
ii	Index of Types of Aids and Systems	193
iii	Index of Names: Personal, Corporate & Organizational	207

PREFACE

Volume II of the **TRANSPORTATION MARKINGS: A STUDY IN COMMUNICATION MONOGRAPH SERIES** continues the studies began in Volume I, Parts A-D. The earlier volume reviewed communication concepts - especially those of semiotics and of the role in transportation markings (Part A) - and it presented a survey of surface, air, and marine markings in the U.S. (Part B). The first volume ended with an examination of one segment of international transportation markings: marine aids to navigation (Parts C & D). Parts C & D were revised and republished as a separate unit in 1988 under the title of **International Marine Aids to Navigation**. A major revision of Part A, **Foundations**, has also been completed. The revision includes an enlargement and revamping of semiotic considerations, an addition of material on electromagnetic and acoustical processes with their role in transportation markings, and an addition of material on design and transportation markings. Part B has also undergone revision including a major expansion of the classifications.

Volume II continues the international studies begun with Parts C & D. There are four intended parts for the second volume: **International Traffic Control Devices** (Part E), published in 1984; **International Railway Signals** (Part F) published in 1991; **Aero-nautical Navigation Aids** (Part G), the focus of the present study; and **A Comprehensive Classification of International Transportation Markings** (Part H), projected.

The present monograph examines currently employed radio and visual aero aids.

Officially-sanctioned aids - as presented in International Civil Aviation Organization (ICAO) and augmented by North Atlantic Treaty Organization (NATO), U.S. and other sources - provides much of the foundation of the study. This format is true of the other monographs in the Series as well. Classification continues its vital role for the studies. A subchapter on aero history is also vital to the monograph.

The monograph views radio aids and visual aids as a single, unified subject. That may run counter to the many who view radio aids as navigation aids, and visual aids as airport/airfield/visual/ground aids. Few, in fact, speak of a single field of aero safety devices no matter what terminology is employed. The problem of a split is mirrored in the lack of an agreed upon overarching term. The use of "aero navigation aids" by the writer may lead to confusion and to irritation by those seeing two disciplines or one discipline with two semiautonomous aspects. Yet some unified designation was necessary if one perceives a single field.

ACKNOWLEDGEMENTS

To Abbot Peter Eberle and the Monks of Mount Angel

To those who assisted in the production of the monograph: Mark Parker OSB, proofreading; Justin Hertz OSB, computer assistance; Pius Harding and his staff at the print shop, covers and supplies.

To many libraries that rendered aid: Air University Library in Alabama; the University of California, Davis Libraries; the University of California, Berkeley Libraries especially Catherine Cortelyou and her colleagues at the Institute of Transportation Studies Library; Congress; Humboldt County Library, especially Lena, the inter-library loan person in Eureka and Joy Moore in McKinleyville; International Civil Aviation Association Library, Montreal; Mount Angel Abbey Library, especially Darlene Strand, inter-library loan coordinator; Oregon State University Library; Portland State University Libraries; University of Oregon Libraries; University of Washington Libraries.

To many manufacturing concerns that supplied information: Airflo Instruments, Glastonbury CN; Thorn Eurothane, Paris; Cegelec, Paris; Crouse-Hinds, Windsor Locks CT; EG&G, Salem, MA; Hughey & Philips, Simi Valley, CA; TWR, Houston, TX; Ameriel, Atlanta; Siemens, Braunschweig, Germany; Godfrey Engineering, Tampa, FL; ITT Avionics, Nutley, NJ; Jacquith Industries, Syracuse, NY; Mannairco, Mansfield, OH; Nautel, Tantallon, NS, Canada; Slo-Idman Oy, Mantsala, Finland; Omnipol/Tesla, Praha; Ulmer Aeronautique, Paris; ADB, Zaventem, Belgium; Unitron International, Atlanta; Danaid, Copenhagen; Toshiba, Tokyo; Valley Illuminators, Tukwila, WA; Westinghouse Electric, Cleveland; General Electric, Hendersonville, NC; Sepco, Windsor Locks, CT; Sylvania, Electric Products, Ipswich, MA; Tull Aviation, Armonk, NY; Multi-Electric, Chicago; Devore, Alburquerque; Wilcox, Kansas City, MO.

To many governmental aviation organizations that rendered assistance: Civil Aviation Authority,

Canberra, Australia; Regie der Luchtwezen, Zaventem, Belgium; Transport Canada, Ottawa, Canada; Civil Aviation Administration, Copenhagen, Denmark; Aviation Civile, Paris, France; Deutsche Flugsicherung, Offenbach, Germany; Aeronautica Civil, Mexico; NATO, Brussels; Luftfartsverket, Oslo, Norway; Civil Aviation Authority, Singapore; Aviacion Civil, Madrid, Spain; Civil Aviation Administration, Norkopping, Sweden; Federal Office of Civil Aviation, Bern, Switzerland; Civil Aviation Administration, Taipei, Taiwan; National Air Transport Services, United Kingdom; Federal Aviation Administration, Department of Transportation, and Department of Defense, U.S.

To individuals and organizations that helped in various ways: European Organisation for the Safety of Air Navigation (Eurocontrol), Brussels; Senator Mark Hatfield; David Page & History of Air Navigation Group, London; National Archives, Seattle & Washington, D.C.; B.A.J. Clark and the Aeronautical Research Labs, Melbourne.

ABBREVIATIONS

Journals

AIM **Airman's Information Manual**
 AIP **Aeronautical Information Publication**
 (published by many nations)
 AI **Airports International**
 AW **Aviation Week**
 LD **Literary Digest**
 SA **Scientific American**
 SNL **Science News Letter**

x

Organizations

AACI Airports Internationale d' Eclairage/International Commission on Illumination
 CAA Civil Aviation Authority or Administration (various nations use either term)
 CAB Civil Aeronautics Board, U.S.
 CIE Commission Internationale
 DOT Dept of Transportation, US. also USDOT
 DOD Dept of Defense, U.S.
 FAA Federal Aviation Administration, U.S.
 ICAO International Civil Aviation Organization, Montreal
 IES Illuminating Engineering Society
 IHB International Hydrographic Bureau
 MOD Ministry of Defense, U.K.
 NATO North Atlantic Treaty Organization
 PICAO Provisional ICAO

Technical Terms: Radio Aids

ADF Automatic Distance Finding
 AM Amplitude Modulation
 BCM Back Course Marker
 DME Distance Measuring Equipment
 DVOR Doppler VOR
 FM Frequency Modulation
 GHz Gigahertz
 GPS Global Positioning System
 Hz Hertz
 ILS Instrument Landing System
 IM Inner Marker
 KHz Kilohertz
 LF Low Frequency
 MF Medium Frequency

xi

MHz Megahertz
 MLS Microwave Landing System
 MM Middle Marker
 NDB Nondirectional Beacon
 OM Outer Marker
 SBA Stanard Beam Approach
 TVOR Terminal VOR
 UHF Ultra High Frequency
 VHF Very High Frequency
 VOR VHF Omndirectional Range
 VORTAC VOR TACAN

Technical Terms: Visual Aids

AAI Angle of Approach Indicator
 AOE Alignment of Elements
 ALSF Approach Lighting with Sequenced
 Flashers
 APAPI Abbreviated PAPI
 AT-VASI Abbreviated T-VASI
 AVASI Abbreviated VASI
 CD Capicitator Discharge
 CHAPI (nothing: CH or Cegelec)
 DBGA Double Bar Ground Aid
 FLOLS Fresnel Lens Optical Landing System
 GAIL Glide Angle Indicator Lights
 GPI Glide Path Indicator
 GVGI Generic Visual Glideslope Indicator
 GVDI Generic Visual Descent Indicator
 HAPI Helicopter Approach Precision Indicator
 MALSR Medium Approach Lighting with RAIL
 MDLA Mirror Deck Landing Aid
 PAPI Precision Approach Path Indicator
 PAR Parabolic Aluminized Reflector
 PCOLA Pulse Coded Optical Landing Aid
 PLASI Pulse Landing Approach Slope Indicator
 PVG Precision Visual Glideslope
 POMOLA Poor Man's Optical Landing Aid

RAIL Runway Alignment Indicator Lights
 REIL Runway End Indicator Lights
 RILS Runway Indicator Lights
 RTIL Runway Threshold Indicator Lights
 RT-VASI Reduced T-VASI
 SAVASI Simplified Abbreviated VASI
 SSALR Simplified Short Approach Lights with
 RAIL
 SSALSF Simplified Short Approach Lights with
 Sequenced Flashers
 TDZ Touchdown Zone
 TLLAS Two-light Landing Approach System
 T-PASI Tactical Portable Approach Slope
 Indicator
 T-VASI Tee-VASI
 TVG T-Visual Glide Slope
 VAPI Visual Approach Path Indicator
 VASI Visual Approach Slope Indicator
 VGPI Visual Glide Path Indicator

General Terms

ATC Air Traffic Control
 IFR Instrument Flight Rules
 NPR Nonprecision Instrument Rules
 PIR Precision Instrument Rules
 VFR Visual Flight Rules
 TISRP This Is Source for Remainder of
 Paragraph(s)

CHAPTER THIRTY-THREE

AERONAUTICAL NAVIGATION AIDS:

INTRODUCTION & EARLY DEVELOPMENT

33A Introduction

33A1 Terminology, The Nature of Aeronautical
Transportation Markings &
Methodological Considerations

A basic term for the totality of aeronautical transportation markings proves to be a problem though a smaller one than for railway transportation markings which lacks any over-arching term. By contrast, marine and road transportation markings each have such a term: marine aids to navigation for the former, and traffic control devices for the latter.

It may be possible to employ aids to navigation since many aero aids bear some resemblance to marine aids and because both share some electronic aids. Admittedly, that use of the term would be an atypical use of it and would undoubtedly create confusion. A 1947 tome entitled **Radar Aids to Navigation** did, however, clearly include both marine and aero navigation aids (ed. by Hall; see especially essay by Buck, Ch 2). The most likely term would be navigation aids since that can encompass both radio and visual portions. AIM - in older editions - employs that term though seemingly no other publication employs it (FAA 1973, Table of Contents). ICAO employs "visual aids for navigation" and "radio navigation aids" (ICAO Annex 10 1985 TC; Annex 14 1990, TC).

U.S. AIP uses "aerodrome lighting and marking" and "navigational aids" and "radio navigation aids" (FAA AIP 1991, TC). Manufacturers use various terms including airport lighting (Crouse-Hinds 1992); aviation lighting (ADB 1991); airport ground lighting equipment (Cegelec 1992); and airfield lighting (Idman ud). To be sure, those terms encompass only visual aids.

This compiler employed visual and radio navigation aids in a letter to the standardization agency of NATO but they were unable to understand my reference. NATO prefers to speak of airfield lighting and marking (Wilson 1993). Navigational aids has a different meaning for NATO. A U.S. Navy essay also employs the term airfield lighting (Naval Facilities 1981). RAE also employs airfield lighting (RAE Smith 1988). Field in his **International Air Traffic Control** speaks of navigational aids having two definitions: "ground-based" aids and "airborne" aids (Field 1985, 26). Airborne equipment is employed to make use of ground aids. A third meaning refers to airborne equipment that takes in data from satellites and natural bodies. Field appears to accept my definition as well as that of NATO. Navigation aids seems appropriate for this study and is, in fact, the only adequate term for the entire scope of aero transportation markings. **Business Week** (11-11-44, 76) speaks of "air navigational aids" presumably for all forms but that is clearly a dated source.

The special nature (or special features of the nature) of aeronautical navigation aids includes several features: 1) all other modes of transportation have nineteenth century

antecedents; 2) many of the elements of the color code and accompanying meanings were in place before aero aids; 3) the technology of signal glass and quality control of glass manufacture had been established by the advent of aero aids; 4) and many elements of transportation equipment were substantially developed. It can also be noted that while conventional airplanes are a primary focus of the study other forms of aviation including helicopters, STOL and V/STOL craft are not excluded.

In addition, an international character was established early for aviation. This was brought about by propensity of aviation to transcend national boundaries, by the need for trans-nation safety aids, and by the involvement of a few nations in pioneer aviation development whose work quickly spilled over the bounds of those states.

The international character and the place of a single agency looms up larger for aviation aids than for any of the other three transport modes. A fully-developed and relatively modern system of navigation aids did not occur until after ICAO came into existence; though, to be sure, substantial work on many of the foundations was underway. This is not a case where international efforts came after a long span of development and in which historical and factors of national inertia precluded a well-thought out international stance. ICAO monitors national divergencies through periodic supplements to the aerodrome agreement. Differences, however, are relatively limited and a general agreement on aids exists (see Supplements to Annexes 10, 14).

By comparison, traffic control devices did not reach substantial convergence until the 1968 UN conference (UN 1969). National and regional customs, over more than fifty years, reduced that convergence and a residue of divergence produces a lingering tension. A somewhat similar situation is found in marine aids to navigation though that divergence, within a recently crafted convergence, is more notable. The national focus of railway signals has substantially blocked a meaningful international system; admittedly, an international dimension to railway safety aids is less essential than it is for aero aids.

An aura of the western nations permeates aeronautical navigation aids and a substantial part of that aura is from the U.S. This may appear to be a regrettable and unfortunate chauvinism. If a world of diverse and numerous nation-states had existed in and around 1900 then a different cast to international transportation markings would presumably exist. But the fact of many colonies and subordinated nations, the possession of much of the advanced technology, communication and transportation systems by a few nations brought about safety aids influenced and shaped by a few nations in the West. Even though many aero aids are relatively new, the long-enduring dominance of aviation by the US and a few European states laid the foundations for a system of aids that continues to be greatly influenced by those same few nations.

Previous remarks on ICAO indicate the place of ICAO, as well as its publications, in the methodology of this study. Among the plethora of ICAO publications three are primary for this

study: **Aeronautical Telecommunications** (Annex 10), **Aerodromes** (Annex 14), and **Aerodrome Design Manual** (Part 4, Visual Aids). Current editions are of greatest importance though past editions have been consulted especially for historical matters. The methodology, though substantially based on ICAO, also includes works of NATO and the U.S. FAA. Selected national publications also have a role as do a variety of manufacturing publications.

The methodology is a relatively simple one: a classification has been constructed using the aforementioned publications. This classification forms the basis of the study out of which descriptions of the types of markings and their messages is formulated. Historical vignettes of aero aids constitutes an outgrowth of the classification and the descriptive treatments.

The lack of a central source of data for the railway signal study required basing that study on the individual systems and which, in turn, required determining which systems were significant in size as well as those that were diminutive. Statistics, therefore, occupied a key position in that study. The core statistic for that study consisted of rail lines mileage/kilometers. While admittedly an imperfect tool for determining signal usage it did afford a means to know which railway systems were more likely to have substantial signal systems and those less likely. Statistics play a less central role for aero aids. Yet knowing the nations that handle large numbers of passengers, cargo and mail - even knowing the length of air routes - can provide an indicator of nations heavily involved in aero aids. The figures will

indicate that a small number of nations dominate the various categories of aviation and statistical compilations. Air route distances was once a common statistic in aviation but that statistic has become much less common as it does not indicate if substantial usage of given routes has taken place.

Sources of statistics include the ICAO annual report, UN **Statistical Yearbook** (1989/1990), **Europa Year Book** (1986), **The World in Figures** (1988), **International Marketing Data and Statistics** (1993), **European Marketing Data & Statistics** (1993), and **New Book of World Rankings** (1991). The most important source is that of ICAO with augmentation from other sources (**ICAO Journal** 1990 & 1992).

It is possible to present a plethora of figures detailing not only numbers of passengers, amounts of cargo and mail, distances traveled as well as more sophisticated indicators that combine passenger, cargo, and distance travel into passenger miles and kilometers and cargo miles and kilometers. That level of detail is not warranted here. In fact a calculation that combines passengers, cargo, and mail and distance will be the primary indicator employed here: tonne-kilometers This figure, not found in many sources (but it is employed by ICAO and also by the UN), considers total weight of an aircraft (including the passengers' baggage) and distance traveled. A tonne-km (or mile-km) is the weight of one ton carried one mile (CAB 1977; also ICAO **Lexicon**). It is the first indicator presented by ICAO. A second indicator, the number of airports, is given by **World Book of Rankings** and that too seems important in gaining an idea of numbers of

aero aids and their diversity and sophistication.

There are approximately 190 nation-states at the present time. These include some micro-states as well as fledging nations wracked by the carnage of conflict that may never achieve an independent existence. ICAO includes 164 in its membership rolls (**ICAO Journal** Annual Report TISRP). The 1992 figures speak of the Russian Federation which seemingly includes the former Soviet Union; the full range of new nations are not included. Quite possibly Russia alone generates most of the aviation activity. ICAO gives details on 90 of the 164. The 90 nations are responsible for over 99% of the tonne-km total. 31 nations have at least one million tonne-km; this constitutes some 93% of the total tonne-km and those nations have received more attention in this study.

Five nations have nearly two-thirds of the tonne-kms: the U.S. (36.2%), Russian Federation (9.9%), Japan and U.K. (each 9.9%), Germany (3.7%) and France (3.6%). A second group have 11% of tonne-km: Australia and Singapore (2.3% each), Canada and The Netherlands (2.2% each) and South Korea (2%). The first two groups have slightly over 75% of global tonne-km.

Two other groups totalling 20 nations contribute 17% of the tonne-kms. Brazil, Italy, China, Spain, Switzerland, Thailand and Scandinavia (Denmark, Norway and Swedish have a joint airline: Scandinavian Air Service or SAS) have 1.0 to 1.6% each of the total. Malayasia, Saudi Arabia, India, Indonesia, Mexico, Israel, New Zealand, Philippines, Gulf States (Bahrain, Oman, Qatar, United Arab Emirates), Pakistan,

Belgium, South Africa and Argentina have .5 to 1.0% each of the total. One final entry may be noted: Air Afrique, though a smaller operation, represents ten west-central and west African states (Benin, Burkina Faso, Central African Republic, Chad, Congo, Ivory Coast, Mauritania, Niger, Senegal and Togo) known as the Yaounde Treaty States.

The New Book of World Rankings provides statistics on airports with scheduled services. The first ten nations have just over half of the world's airports with scheduled services. The U.S. has 21% of the total and Australia has 11%. Papua New Guinea has some 4.5% though it does not rank high in other statistics. Brazil, India and Indonesia have from slightly less to slightly over 2.5% each of the total. Colombia and China have 2% each and Mexico and France 1.8% each. Other nations with more than 25 airports include Japan and Argentina (1.7% each); Canada (1.6%); USSR (1.3%) and The Philippines (1.1%). Norway, U.K. and Venezuela have 1.0% each. Italy, New Zealand, South Africa, Sweden, Madagascar, Malayasia, French Polynesia, Ethiopia, Germany, Greece and Spain hae .7 to .9% each of the total. 70% of the nations included in the earlier statistics are also represented here. Papua New Guinea, Madagascar and French Polynesia are not included in the early statistics but Ethiopia is so listed and ranks 53rd. Colombia at 32 and Venezuela at 34 are very close to ranking on both lists. For that reason Columbia and Venezuela are added to the major aviation nations for this study but not Papua New Guinea, Madagascar or French Polynesia.

ICAO has received an uneven response to queries about compliance/non-compliance with its standards for aero aids. This can be seen in the Supplements where only a minority of member-nations respond. The attempt to gain information from nations active in aviation has had a similar fate. Slightly under 50% of those nations responded to requests for data. More positively, some 80% of the very active nations (the first ten) responded. The information received ranged from miniscule to massive.

The statistical study has proven to be of value though often in ways not directly germane to the original intent of the survey. It has helped to confirm the markedly high level of consensus in international aero aids. It has also highlighted the terminology conundrum: requests for visual and radio aid data frequently resulted in radio information only. This supports the view expressed earlier that for many persons in aviation the term navigation aids means only radio aids even if one sought visual aids material as well. One correspondent even assigned visual and radio aids to the field of avionics which can be far removed from both visual and radio aids.

33A2 Aeronautical Navigation Aids: Physical Properties & Semiotics

There are several basic tools that can be employed to study transportation markings:
1) Semiotics studies messages and their meanings and that proves fruitful for the entire Monograph Series. 2) Communication theory goes beyond semiotics by including the physical dimension of the communication process. See

Foundations (Part A, 2nd ed) in this Series for further information).

3) "Semiotics of the Object": Roland Barthes (Barthes 1988, 180-184) crafted what he termed the "Semiotics of the Object" which focussed on objects not considered to be semiotical in intent. That approach is important for transportation markings not only because it can encompass all dimensions of transportation markings but also because Barthe saw the semiotic of the object within a framework of the symbolic and of taxonomy. Both elements are vital to transportation markings.

4) Technology and Physical Properties. While the studies are not technological treatises they do include technology and especially the descriptive treatment of physical properties. Physical properties treats of the technology as it creates and frames the means through which messages are composed and emitted. It goes beyond the concerns of physical processes in communication theory and also goes beyond Barthe's semiotics of the object.

In this monograph only a terse treatment of these several topics can be employed. Those topics will center on semiotics - and especially aspects most vital to markings, and on physical properties (but without a formal review of communication theory, the semiotics of the object or technology). The topic of classification is taken up in Chapter 34.

This introduction to semiotics and physical properties may be overly long for the accompanying treatment. The length is prompted by a review of introductory materials in Part F.

That review revealed that while all these topics are included they lacked the necessary coordinating linkage. These present comments are intended to be a contribution to the entire Monograph Series. Chapter 1 of **Foundations** takes up these matters in more detail. The Prolegomena of that study may also be consulted.

Semiotics can be briefly defined as the study of signs in whatever form. Only one phase of semiotics, that of semiosis or sign process needs to be discussed here. **Foundations** offers a longer review of semiotics as well as providing information on sources. Two dimensions of semiosis, sign and signification, are of particular importance here.

Sign, in a semiotic sense, can be viewed as the visual aspect that a transportation marking (or other semiotic sign) displays. In some transportation markings, such as unlighted signs, the semiotic sign and the physical dimension of the marking are virtually fused together into one unit while in other markings the message and physical properties can be more readily separated. Signification can be regarded as the meaning that a message conveys; for example, a fixed green light signifies, or has the meaning of, "proceed" in traffic signals; green has more atypical meanings with aero threshold or taxiway centerline uses.

It may be noted that semiotic professionals may prefer physical sign, form or designator in place of sign, and they may further prefer message/meaning or designatum in place of signification (Givon 1990).

It proved to be a relatively simple task to describe railway signals in semiotic terms. For example, the term "aspect" in railway jargon equalled sign, and the term "indication" denoted signification. Railway signals with its changing colors and other symbols and accompanying messages fitted well with semiotic concepts. (see also **International Railway Signals**, Part F).

Aero navigation aids can be viewed in a semiotics framework but it is more complex and less easily grasped since, paradoxically, its simpler caste is elusive and less immediately displays the dimension of meaning. Instead of a single unit displaying a color (the sign) with its meaning (signification) one is confronted with (in many instances) rank upon rank of fixed lights emitting a steady burning and never changing message. Instead of a unit saying, "caution" or "proceed" or "halt" one is presented with a row of single color and unblinking lights. For example, a pattern of blue lights for a taxiway consists of dozens of lamps and they never do anything other than display that fixed blue indication. What do they signify? They denote the bounds of the taxiway lane which are the spatial limits of safe navigation after a plane arrives.

Marine aids to navigation employs many channel markers; which, though somewhat similar in function to aero aids, bear marked differences. Each marine aid has an identity in itself, each aid identifies a location as well as forming a segment of a pattern of markings, and each can be more precisely defined semiotically than aero counterparts. Aero aids therefore display a semiotic notion but in a

different configuration than many other transportation markings. Interrelationships are more important and individuality is less so. This is less true of obstruction and some approach aids but it is true of most other aero navigation aids.

The physical properties of aeronautical navigation aids include the specific medium they adopt, the actual configuration of the aid, and the nature of the message that the aid is capable of producing and displaying. The technology of the aid is included though more in a descriptive manner than in an explicitly technological fashion in this study.

Mediums refer to how the aid produces and emits the message. The basic mediums are the visual, the electronic, and the acoustical. Both the visual and electronic have major roles for aero aids. Electronic impulses take on a visual and/or acoustical form in the aircraft-borne receiver. Acoustical is not found with aero aids otherwise (though there is a curious acoustical signal that appeared briefly in the 1930s; see page 28). The visual medium contains all-lighted, partially-lighted, and unlighted variants.

The fully-lighted variant is relatively small since only approach and related lights are in use around the clock. Partially-lighted has a somewhat different meaning for aero than it does for marine. Partially-lighted for marine indicates an aid with explicitly day and night dimensions. But with aero aids it refers to a light-only aid that functions only at night and in limited visibility. Pavement markings, a separate aid, often furnish the day dimension.

Signs are a point of confusion since they often have a lighted dimension, though not always, which places them within both unlighted and partially-lighted categories.

Partially-lighted signs adds an additional variant meaning to that phrase. Unlighted aids are largely in the form of markers and markings; obstruction aids are also included in that category. There is a marked degree of uniformity in the mediums. Unlike railway signals a given form of aid varies little from airport to airport or from manufacturer. The physical differences in manufacture are quite limited since standards are precise in their requirements. What differences there are pertain to intensity (high, medium, low) and to direction (unidirectional, bidirectional and omnidirectional).

There is a narrow and uncertain line between the physical properties of aero aids and the semiotics of aero aids. Signs and markings closely integrate the physical and symbolic but for many lighted aids it is possible to distinguish between physical and semiotic. However, the nature of the message capability of a transportation marking partakes of both dimensions. The nature of the message that an aid can produce ties together the physical and semiotic meanings of aero aids. Since the nature of the message is tied more closely to the physical that topic is attached to physical properties aspect of the coverage.

The nature of the message concept is first found in Volume I, Part A, 1st edition. It is reproduced here to provide both context and linkage for aero aids. It is reproduced here to

provide a context for aeronautical messages. Many aero aids messages are similar to those of marine aids: a message that is single and unvarying. This is in contrast to many rail and road signals which provide a variety of messages. But the message configurations are more complex than those two examples. The basic construct of message capability natures has this pattern:

1. Multiple capability that permits Changing Message/Multiple Message (C3M);
2. Message capability that permits only Changing Message/Single Message (CMSM);
3. Message capability that includes an Unchanging Message but with Multiple Messages (U3M);
4. Message capability that is restricted to Unchanging Message and Single Message (UMSM).

The fourth form (UMSM) includes the following sub-categories:

- I. Programmable Transportation Markings.
- II. Unitary Markings include several variants:
 - A. Single and unchanging message;
 - B. Intermediate which permits one of several predictable versions;
 - C. Individual which includes markings for whom few, if any, predictions can be made.

Most, perhaps nearly all, aeronautical navigation aids are UMSM. Most of these are within the II.A. sub-category. Some signs and pavement markings are within II.B. and a limited number may be within II.C. Stop and Clearance Bars are in all likelihood part of the first category, Changing Message/Multiple Message (C3M).

33B History of Aero Navigation Aids

33B1 Introduction & Early Aviation Developments

This study focusses on current aeronautical aids. It is not a history of aviation or even of aero aids. However, aviation seems to be a virgin field in many respects; written materials that exist for marine, road and rail may not exist for aero studies. For example, a variety of historical studies exist for traffic control devices (Sessions 1970 and Mueller 1970 among others have written extensively on that topic). Yet comparable studies are not available for aeronautical studies.

In the 1970s I attempted to find information on taxiway lights. My sources included primary ones such as Charles Douglas, formerly of the National Bureau of Standards, who was involved in aero lighting in its earlier period. Other materials included people still living and technical information. Elimination of Douglas, other living resources and hard-to-find materials would have had the end result of little available information on taxiway lights. More recently David Page (History of Air Navigation Group of The Royal Institute of Navigation, U.K.) has indicated that while they are studying the history of navigation (and radio aids to a degree) they have not studied visual aids and have few clues to that history (Page 1993). Remarkably, even though that group is in close proximity to the subject of aero aids they have encountered little information on it.

Therefore this subchapter will endeavor to offer a sketch of some seminal events in aviation history and of the development of aero

aids. A half-chapter cannot be definitive but at least an outline of the subject can be given. This may suggest to a reader that a general history of aero aids is very much needed.

Chapter 33B will consider three themes: aviation developments and aero aids to 1937 (33B2), a segment which stops at a seemingly arbitrary point but a point that actually encompasses a plausible period of development; aero aids 1938-1943 (33B3), a short selection that includes numerous significant events; 1944-1950, a period that includes the early years of PICA0/ICAO and vibrant with aero aids developments (33B4). 33B4 also includes international cooperation before 1944, and an epilogue on approach lighting after 1950 because so many foundational developments fall outside the time frame of this segment.

The airplane became a reality in 1903 in North Carolina. Even though some time was to pass before the airplane could be seen as a practical machine, it was not that many more years before the airplane became relatively commonplace with both passenger and mail services available (Gibbs-Smith 1985, 94).

Passenger services began in Italy during World War I and several other passenger operations were established in Europe before World War I ended (Warner, 1938, 34-35). Regular passenger service did not begin in the U.S. until 1927 (Taneja 1987, 2).

Several flights transversed the Atlantic in 1919 including a non-stop flight; this marks the expansion of flight beyond continental bounds (Gibbs-Smith 1985, 181). The 1920s is very much

and the airway spanned the continent before 1926 ended. Great aerial lighthouses were established in Europe but they were few in number and any form of systematic lighted route was unheard of. However, Europe was well ahead of the U.S. in radio aids and established frequent radio units providing direction finding capabilities for aero navigation.

Before 1939 nearly all of the world had been reached by aeronautical transportation. Between 1931 and 1935 the British Empire and Commonwealth had been stitched together by air: Central Africa in 1931, South Africa in 1935, East Asia in 1933, Australia in 1935. Air service between Belgium and the Congo were established in 1935. And French Indo-Chinese air service began in 1938. Pacific aviation was established in 1935 and 1936 from the U.S. The rugged terrain of South America proved to be an impetus for developing aviation and a variety of carriers offered service either to restricted or continental areas of the continent.

Areas that were developed relatively late included Canada and the North Atlantic. Aviation was certainly present in Canada but trans-continental service did not begin until 1938 (Davies 1989, 169; Finch 1938, 21; see also Follett). But the thinness of the population, proximity of most residents to the U.S. and its aviation system, and extensive rail networks mitigated against early continental developments. The North Atlantic was the last principal region to experience regular air service. Distance and state of aircraft development precluded early development of that route. It was only on the eve of World War II that regular passenger service was begun. And it ended within a few weeks not to recommence until after the war.

a pioneer era for aeronautics yet both experimental flights and even regularly scheduled services began in that time. KLM began service to what was then termed the Dutch East Indies in 1924 (Finch 1938, 159). Air France reached South America in 1927 and 1928 through a multi-phase process via Natal in west Africa. Aptly named Imperial Airways (U.K.) reached India in 1929 (Finch 1938, 19). An experimental flight from California landed in Australia in 1928 (Finch 1938, 199-200).

But these flights were not at night. Imperial Airways, for example, took nearly a week to reach India in the earliest period of flight and the route was flown in segments and only in daylight hours (Harper 1930, 141). Night flying took place in Europe but only in the summer and in northern latitudes where darkness was very limited in that season. some experimental nights flights also took place (Warner 1937, 27). Saint Exupery describes night mail flights in South America made without navigation aids but it is not clear how extensive that practice proved to be (Saint Exupery 1942).

Night flying as a regular event took place only in the U.S. during the 1920s and that was exceptional even in the 1930s. Warner views the lighted airway system of the U.S. as the greatest contribution to aeronautical operations by the U.S. (Warner 1937, 26-29 TISRP). The U.S. Army established the world's first lighted airway (with regular, scheduled flights) in 1921 in Ohio. The Post Office took over that route and expanded it from Chicago to Cheyenne in 1923 and regular air mail service began in the following year. New York was included in 1925

33B2 Early Development of Visual Aids

Aero lighting of the 1920s and 1930s was markedly simple. The controlling image of that early phase of lighting for many people may center on early airway beacons whether a great aerial lighthouse in Europe or the vast system of beacons strung across American prairie and mountain. However, many of the lights were far more prosaic and oft times they were boundary lights.

The boundary light, as the name implies, outlined the total landing area of an airport. It did not delineate approach channels, runways or taxiways (Wood 1940, 311; Duke 1927, 122). Despite what it "did not delineate" the boundary light is the probable precursor of many contemporary forms of lights including threshold, runway and taxiway. LD spoke of "border lights" in 1926 and these were presumably the same form of light (Lighting the Night Mail, 7-31-26, 18).

Standardization of messages did not reach contemporary levels but some general statements can be made. U.S. forms were white in color (though in 1929 the Dept. of Commerce provided for either white or yellow lights; Aids to Better 1929, 127) while red remained in considerable use for many other nations (Black 1929, 160). But exceptions exist: St John Sprigg speaks of amber (a saturated form of yellow) and Finch notes the use of international orange (St John Sprigg 1934, 109; Finch 1938,

28). Lights could be either fixed or flashing though fixed was more common (Black 1929, 160).

Even at an early date it was recognized that some approaches to an airfield were superior to others and this recognition led to use of green lights, known as range lights, within the line of boundary lights for recommended approaches (Black 1929, 16). One source (The Lighting of Airports, 1928, 104-105) speaks of these lights as approach lights. However they bear little resemblance to approach lighting. What they do resemble are threshold lights. Later on green not only designated the best approach but the importance of a given runway at an airport. The importance of a runway was denoted by the number of green lights (2, 3 or 4) (Wood 1940, 311-312).

The spacing of boundary lights varied from 200 to 300 feet. 300 feet became the maximum permitted spacing in the U.S. (Black 1929, 160; Duke 1927, 122; Wood 1940, 311; Whitnah 1966, 35). Some boundary lights were equipped with red globes. These lights denoted hazards near the landing area and supplemented standard obstruction lights. Contemporary lights infrequently have a day dimension but that was not the case at an earlier time. Boundary lights were equipped with a cone-shaped object of sheet metal and painted to denote a message corresponding to the night message. Two yellow bands intersected by a single black band denote a regular boundary light. Range lights displayed vertical chrome yellow and white stripes (Aids to Better 1929, 127). Presumably boundary lights were fixed though one journal article described a flashing boundary light. Quite possibly that never went

beyond an experimental stage (Flasher Lights 1934, 38).

The impression that specific colors have certain meanings has long persisted. For example, yellow means caution, green denotes proceed, red indicates danger. But only the color red has long had the message associated with it (the color termed ruby may well be within the red spectrum. Some older sources use the term but not more recent ones. An article in **AC** mentions ruby for obstruction lights; Lighting in 1928, 104). This is very much exemplified by obstruction lights: they are red in all nations and at all times. White strobe lights represents a recent exception; an obstruction light at Chicago was also white (O'Dea 1958, 105). Possible confusion over colors and meanings that may be found with boundary lights and even with beacons is absent with obstruction lights.

Early obstruction lights were to be found in both fixed and flashing forms. Many were incandescent though some neon forms were employed (if CAA's reference to a gaseous form indicates neon; CAA 1941, 16-21). Boundary light sometimes included mention of obstruction lights. One 1929 source describes that form of obstruction light in detail and further notes that the cone was painted in red and white vertical stripes (Aids to Better 1929, 127). There are numerous references to obstruction lighting; two older sources are Harper 1930, 128 and St. John Sprigg 1934, 109. **LD** refers to "red guard-lights but presumably the same form of light was meant (Lighting the Night Mail, 1926, 18).

Beacons are the most visible element in early aviation developments. Light sources for beacons included incandescent, acetylene, electric arc and neon forms. Incandescent and acetylene were the most common forms in use. Few beacon lights were of a fixed character; most either rotated or flashed. In most instances larger beacons were of the rotating form (Black 1929, 152; Lighting in 1928, 105; see also numerous journal articles and treaties on early aviation). **LD** notes a great beacon that pointed skyward and so rotated that an enormous circle was created that could be seen 50 miles (Night Mail, 1923, 17).

U.S. Airway beacons were of two types (Komons 1978, 135-136 TISRP). The first and older one displayed a single-direction 24" lamp. The lamp rotated a white message. The tower was constructed on a concrete slab in an arrow shape with a black edged yellow pattern. There were course lights as well on the tower. One faced toward the next tower while the other faced toward the previous tower. Two successive towers displayed red lights; the third tower displayed a green light denoting an intermediate landing field. The course lights flashed according to a Morse code characteristic denoting a number from one to nine. The numbers represented the position of the tower in a one-hundred mile segment of the airway.

A new light was introduced in 1931 Komons 1978, 135-136; see also Airway Beacons, **SA**, 12-32, 323). This was a double-ended lamp with clear and colored flashes; these were either red or green according to the position of the beacon on the airway. Course lights were no longer needed. This beacon was a standard for U.S.

aero lighting; the lamp revolved six times per minute (FAA 1980). The code beacon was introduced in the early 1930s (Breckinridge 1955, 9; sources are abundant for many topics but the code beacon has been seemingly overlooked and source materials are limited). This beacon performed a variety of functions and continues in use to the present day. It served not only as a code beacon (displaying Morse code characteristics) but also as an auxiliary beacon and hazard beacon. Its role as a hazard beacon is the present primary function of that beacon.

A variety of auxiliary beacons were employed as well. These included a routing beacon which was similar to marine lanterns (The Night Mail in Reality 1923, 16-17). This beacon was placed at regular intervals between the main beacons. But it was seemingly employed for only a few years. A range lantern was also employed in hard to reach localities (Komons 1978, 137). The range beacon had a second purpose as well. In rugged terrain, where a beacon might not be seen at any distance, the range lantern was employed between the main beacons.

Komons (1978, 134-135) notes that the essential notion of aerial lighting originated with marine aids to navigation; this fact influenced the placement of the Airways Division in the Lighthouse Bureau. But marine and aero navigation do not represent identical situations and U.S. airway lighting diverged from marine practices. But in Europe aerial lighting closely imitated that of marine lighting. Europeans created literal aerial lighthouses of massive power. Intermediate landing fields were absent as well as evenly spaced airway beacons.

The European approach is exemplified by the Dijon aerial lighthouse built in 1923 (The Aerial Lighthouse 1923, 400 TISRPS). This single light marked the Paris-Algiers aero route. The Dijon light was 10 meters/33 feet high. It contained two groups of lenses which faced opposite directions. Each group of arc lamps produced a one billion candlepower beam which constitutes an incredibly powerful light. But instead of a well-marked path from Paris to Algiers the aviator had this single, vast optic for guidance.

A somewhat smaller beacon was produced by AGA. This was presumably of less power and seemingly a manufactured beacon in contrast to the the Dijon light. But it too was also an aerial lighthouse and one that bore a striking resemblance to marine lighthouses. The AGA beacon comprized a revolving lamp and lens within a glass lantern house. However, it did not have the precise focus of the U.S. beacons.

Goldstrom notes that there are three forms of beacons: aerodrome, "flashing beacons near large centers" and the long-distance forms (Dijon and Valerian). There is seemingly few other references to the flashing beacons that Goldstrom mentions (Goldstrom 1930, 144).

Aerodrome beacons in Europe and Australia, were often of a neon form (see Parnell & Boughton 1988, 153, on Australian developments). Some observers were of the view that red neon lights were especially fog-piercing (Caldwell 1930, 316-317; other sources for this topic include Black 1929, 162-163; Harper 1930, 127). Others claimed instead that any form of red was fog piercing. A third view suggested that neon

red was more effective because of longer wave length. White can be seen further than any color and it is not clear how red, neon or otherwise, was superior to white in fog. Norvell notes that red and yellow are better in fog not because of their longer wave length but because fog creates more of a halo effect around shorter wave lengths of, for example, blue and green, which in turn creates glare near the light source (Norvell 1940, 116). Westinghouse produced a sodium light in 1939 that pierced fog more effectively as compared to incandescent light. It is not clear whether it was the form of light or the fact that the sodium lights were amber (saturated yellow) that constituted the improved visibility (Sodium Lights 1939 (Sept): 158.

Wind indicators, both wind cones and wind tees, were an early feature of aviation. The characteristic shapes of wind indicators is virtually unchanged over 60 or more years. O'Dea notes that presence of an unspecified form of wind indicator at Hounslow in 1920 (O'Dea 1958, 105). Wind cones were in use in 1929 and probably for some years before (Black 1929, 116). Wind cones were often lighted; the lighting providing a substitute for daylight rather than as a message in itself.

Wind tees are more frequently mentioned in the literature. They were equipped with green lamps outlining the "T" shape which is the contemporary practice as well (Duke 1927, 122-123). Lighting for wind tees, in contrast to wind cones, is part of the message. Wind tees may have lost their official status, at least in the U.S., but they continue to be manufactured and employed and the shape and

lighting are unvaried from that earlier period. See Lighting of Airports 1928 on this topic.

The full panoply of aero signs and markings did not exist at an earlier day. Signage and pavement markings (lines, words, numbers) were substantially absent. Nonetheless, there were markings in great abundance of some types. There was a great concern to paint the names of towns on roofs during the 1920s as is attested by the literature (see for example, Air Markers 1923, 58; Young 1928, 127-192; Making the Air Safe for Everybody 1923, 58; Airmarking for Cities 1927, 307; Airmarkers, *Time*, 1936, 48). Distance and directional arrows sometimes accompanied the name of the town. Lighting, either by floodlighting or by creating words with individual lamps, was sometimes employed. Names of towns were painted at airports as well. Letters were frequently in chrome-yellow on a black background (Young 1928, 127).

Circle markers were to be found both in North America and in Europe. These markers, as much as a 100 feet in diameter, marked the location of airports. Smaller circle markers sometimes denoted runways (Greif 1979, 12-13). White seems to be the predominant color for the various markings. The day dimension (which could appropriately employ the marine term, daymark) of boundary lights is considered in the treatment of boundary lights. And the material on airway beacons includes mention of accompanying directional arrows. Harvey notes the use of "homemade boundary markers in the early post World War I era and these were also in white; lights were added to some of these markers at a later time (Harvey 1941, 84).

Visual aids, though prominent, did not make up all the navigation aids before World War II. Aero radio aids were introduced early in the century and soon manifested several forms. Radio aids included approach aids, non-directional beacons, guidance aids and rotating beacons.

Floodlights are not included in this study since they are more akin to sunlight than to aids to navigation. The status of ceiling lights is less clear. These lights illuminated the cloud cover and its heights. They are possibly a form of navigation aid (The Lighting of 1928, 106).

Probably the most unusual aero aid was the "sonic marker beacon". It might be seen as the aviation equivalent of a marine acoustical or fog signal. Its role was similar to radio marker beacons. In theory the pilot would hear the first beacon when past the 500 foot point before the boundary of the airport. After entering a middle area the pilot would hear a second sonic beacon. It was developed by General Electric and underwent tests in 1933. Little evidence of this unusual aid is in the literature (Sonic Marker Beacon 1923, 32). The vagaries of acoustical signals would seem to quickly eliminate such an aid for aero purposes.

An early form of the rotating beacon was produced by the Telefunken Company in 1907. This beacon contained 32 aerials (one for each point of the compass) grouped around a central aerial. A complete transmission began with a starting message from the central aerial with each of the other aerials transmitting in turn. Position was determined by measuring the

transmissions, beginning with the central signal, and continuing until the signals reached the zenith of power; the most powerful signal indicated the aircraft's position. The Telefunken beacon is regarded as the predecessor of all rotating beacons since it was ground based rather than airborne thereby permitting unlimited use of the beacon, and because the quality of transmissions was unaffected by airborne equipment (Kendal 1990, 315). The U.S. began work on a rotating beacon in 1936. This and other work resulted eventually in the VOR or VHF Omni Range aid (Kendal 1990, 320-321).

The Course Setter of Otto Scheller (Lorenz Company) produced a means of determining an aircraft's course with one radio unit; this too was in 1907 (Kendall 1990, 321). The unit's two aerials each transmitting a letter: "A" by one and "N" by the other. If "on the beam" the aircraft received a steady hum of the merger of the two letters. But if off course then "A" or "N" was received. Further tests were conducted but aircraft aerial problems terminated the development of the course setter. However, it serves as a forerunner of other guidance aids.

Early radio beacons developed by Marconi developed a "wireless lighthouse" or radiobeacon in 1916. They were primarily marine in focus though some aero use of the radio beacon occurred (Kendall 1990, 318).

The U.S. Post Office experimented with radio navigation aids in 1919 and 1920. They created a directive beacon employing a spark transmitter over the Chicago-New York route. The experiment was short lived but the U.S. Army continued work on radio navigation and eventually played a role

in the development of the radio range (Komons 1978, 153-154).

The Radio Range is based on the work of Scheller. The Scheller form transmitted interlocking signals from aerials producing figure-of-eight patterns. This created four ranges or tracks. The patent for this aid was filed in 1916. In 1924 the U.S. produced the radio range based on the earlier work. It was a MF unit and became standard U.S. radio aid until VOR in the 1950s (Kendal 1990, 319). Grover, however, lists it as a LF/MF frequency aid (Grover 1957 41). Much of the practical development and application was during the years 1928-1931. The transmission was a Morse code one of A (._) and N (._) (Kayton 1990, 229; see also Komons 1978, 155-161; Hall 1947, 44-45).

The Radio Range provided information on direction along the range but not the actual position of the aircraft. Marker beacons were added that provided that information. The transmissions were fan-shaped along the track and cone-shaped at the the station itself (Grover 1957, 41). The messages were received in the aircraft in both lighted and aural forms (Kayton 1990, 229).

A fuller development of the Course Setter known as the Standard Beam (SBA) created an airfield approach system. SBA was widely employed in U.K. until ILS superseded it. The unit provided azimuth and location information through the employment of marker beacons thereby assisting aircraft in their landing approach (Kendal 1990, 321).

Bellini-Tosci in 1907 created an early version of the ground based direction finder (DF). A fuller development resulted in a major system of aids that was the standard aid for European navigation until VOR. During World War I both U.K. and Germany established stations along their respective coasts; stations were also established at airports. The system had shortcomings for nighttime use and a different aerial system known as the Adcock was substituted (Kendal 1990, 324-325).

Early work on ILS began in the 1920s and 1930s in the U.S. Work began in 1919 and one system had been tested by 1929. VHF range was found to be the best frequency in 1931. The three current elements of glide path, localizer and marker beacons were determined early in ILS development. Conflicting ideas slowed development of ILS until the early 1940s (Wilson 1979, 127-128).

33B3 Development of Aero Navigation Aids,
1938-43

The complexity of runway and taxiway lights and accompanying lights of current airports contrasts sharply with airport lighting in the 1920s and much of the 1930s. There was a single form of lighting for most airports in that era: boundary lights. The range lights that were in use constituted an integral component of boundary lights.

Gradually other forms of lighting were added: these included runway edge and threshold lights. Lights not only included cone shaped boundary type lights but semiflush lights, and lights on pedestals. There were high intensity lights as well as low intensity forms. Lights known as strip lights joined boundary and runway lights.

Airport lighting developments become confusing since boundary lights did not vanish to be replaced by other forms. Boundary lights continued in use while other forms were added on. During a transitional period the various forms overlapped with one another and perhaps were not far from contradicting one another on occasion.

Despite the multiple forms of lights in use during that time, it may not be far fetched to suggest that boundary lights are the basis of many airport lighting forms. Boundary lights began as a macro state outlining the entire landing area and evolved to micro forms delineating a precisely formed runway. Range lights evolved into threshold lights. And in situations where red lights existed (Australia

for one) in the line of boundary lights they became runway end lights. Runway lighting standards in about 1940 consisted of contact lights spaced 200' apart with 1000' of yellow lights from the threshold point followed by 3000' of white lights (Norvell 1940, 116).

There is, however, no simple evolutionary process. Old forms and new forms became intermingled. Yet boundary lights can be seen as the antecedent, as an evolving core to the developments that followed.

Taxiway lighting is a relatively recent development. Early airports were simple affairs with boundary lights and, frequently, floodlights. Runway lighting was generally absent and taxiway lighting was fully absent. Douglas of NBS states that taxiway lights did not exist before September of 1938 but they were in use by 1941 or 1942. An 1946 U.S. publication from the Army-Navy-Civil Committee established what may be the first standard for taxiway lights (Army-Navy-Civil Committee 1946; also Navy 1946).

Taxiway lights were blue in color. Taxiway edge lights were initially semi-flush in character though some elevated models for snow areas were in use. Reflector delineators were also provided (Navy 1946, 10-11).

The original approach lights consisted of neon lights in a short row installed to the left of the runway. The neon lights were of greater intensity than other airport lights and this greater brightness led to a proposal to use them day and night. Up to that time airports lights were in use only at night. Tests at Nantucket

and at Indianapolis found that approach lights were of value during foggy periods during the day. Two rows of lights were preferred to the current single row. A form of light known as the Bartow light was employed during World War II in Alaska and had two rows of lights. But the lights were weaker than the test patterns and were of limited value. It is not known precisely when approach lights were employed and there is a double problem of experimental work and official status. The exact beginnings of approach lighting has not been located by this writer. Wood makes mention of this form of lighting in 1940. Breckinridge speaks of approach light early in the 1935-1945 decade. References for approach lighting include CAA Pushes 1950, 47; Kroger 1948, 21-22; CAA 1941, 16; Breckinridge 1955, 15-16; Airport Lighting System 1939, 375; Wood 1940, 312; Glidden 1946, 194.

Final approach glideslope indicators development occurred largely outside this time. However, one form was developed by Royal Air Force (which later developed PAPI). This early indicator which was a optical projector ground aid was a three-color system displaying green to a pilot on the glideslope, a red warning if too low and an amber message if too high. Most later indicators are two color systems but some three-color types are in use (Clark & Antonenko 1993, 51; Clark & Gordon 1981, 1).

Runway lights, as distinct from boundary lights, began between 1936 and 1939 (Breckinridge 1955, 13, 15-16; Wood 1940, 312). These lights known as contact lights of the marker type (so named since "they do not attempt to light the surface of the runway.

Instead they direct their light toward the incoming pilot" (Norvell 1940, 44) were originally of a semi-flush design. Quite early in their development they displayed two colors: amber or yellow for the lights at the beginning of the runway, the first 1000 feet, and white beyond that point. Threshold lights, presumably a descendent of boundary range lights, were green. Red lights for runway ends were employed at an early date in Australia; red was also employed for wrong-direction warnings already in 1939 (Parnell 1988, 153).

Beacons continued on in a similar pattern to the earlier period. Some newer forms were added for smaller airports and cold-weather usage but they did not essentially alter the existing forms. Breckinridge speaks of the wind-tee as coming into use during this time period but older sources clearly indicate its use in the 1920s (Breckinridge 1955, 14).

Radio aids did not vary greatly from the earlier period. Radio ranges, marker beacons, and direction finding units continued in use. Work toward what became VHF Omni Range (VOR) was well underway however. In the U.S. experiments with VHF began in 1937 and an actual change from MF to VHF commenced in 1940 but war requirements ended the project. The old radio range was a four-course arrangement and early VHF was a two-course system. But research developed a omni-range VHF system in 1943. But it was not until the early 1950s that VOR became a reality. Principal reference for this coverage is Kendal 1990.

During 1939 and 1940 various ILS systems were tested. A system developed by

International Telephone Development Company (ITD) eventually was selected. A great deal of wrangling between civil and military aviation interests slowed the project and the start of World War II largely ended the project during the war. A few civil airports and some military airports did have the system during the war (Wilson 1979, 127-129; also Kayton 1990, 237; and Kendal 1990).

33B4 Final Development of Aero Aids Before ICAO Standards, 1944-1950

Approach lighting has undergone only limited change for the last quarter century and much longer for some key concepts. This is true for lights, messages and equipment. This is remarkable both in regards to other aids and to the turbulent history of approach lights. Many airport have undergone design and technological changes over four decades, and some new aids have been added but approach lighting has been largely unscathed.

Two qualifying statements need to be made regarding approach lighting and its coverage in this segment. Even though general agreement was reached early in the 1950s on approach lighting it was not until the late 1960s that the U.S. government approved and implemented what been substantially agreed upon long before. Pre-ICAO aero aids coverage ends in about 1950 since by then ample standards have been prepared and implemented. But approach lighting was somewhat slower in development and because of the tardiness of the most active aviation nation, the U.S. For that reason an epilogue has been added to this segment on more recent events in approach lighting.

The United Kingdom developed its approach lighting system in the 1940s and that system is sustantially the same today. By contrast the U.S. has experienced multiple and contradictory developments in its first years of development. Even a cursory sketch of that development borders on the incredible. This treatment is

disproportionately centered on the U.S. because so much of the turmoil took place there.

The source materials for approach lights part of this segment overlap and interweave with one another; therefore the sources are grouped together here: Kroger, 1948, 18-25; New Lighted 1948, 374; Wilson 1979, 236-241; Lights for Landing 1958, 58. And a long series of articles in **Aviation Week**: Approach Lights 5-8-50, 46-47; Lights Squabble 5-2-49, 14; New Policy 11-20-50, 55; Slopeline Light 12-6-48, 15; ALPA-Recommended 3-7-49, 40; CAA Pushes 6-19-50, 47-49; Moore, 12-11-50, 46-52; CAA Tests 7-49, 43.

Indianapolis was the site of many early (1945) experiments including Bartow lights, centerline lights, and "angled approach" systems. Arcata was perhaps more notable with the passage of time. In 1948 the U.S. was close to approving the Slopeline Approach Light system. That system consisted of two rows of lights having the shape of a funnel with the narrow end near the runway threshold. The light units making up the rows were at a 45 degree angle and each consisted of 10 sealed beam lamps. When a pilot was on course the two rows of lights displayed two lineal strips of light. But when off course the lights took on the appearance of a slanting picket fence. Height and position of the plane could be determined by the direction and slant of the light units. In 1948, as approval seemed near at hand, the CAA was both preparing specifications and bids for the slopeline system and preparing for further tests for a centerline approach system that airline pilots preferred to the slopeline.

In 1949 ALPA strongly criticized the CAA's testing program at the Arcata Airport (McKinleyville, CA). A key criticism concerned the much greater intensity of slopeline lights in the test than that of the corresponding centerline lights being tested. In the spring of 1949 the slopeline system was approved. And in the spring of 1950 the slopeline system was given high grades for its performance; however the evaluating agency was the CAA who had a vested interest in a system that they created. But the approval had little meaning since ALPA did not relent in its opposition. In addition, U.K. and France were not enamored of it, and over 50% of U.S. airports were unable to use the slopeline system. The CAA reverted to a 1947 arrangement of a single row of lights to the left of the extended centerline. This was accomplished by placing the slopeline lights in a true horizontal plane. But that attempt at a solution did not succeed.

In 1950 IATA, after a thorough study, approved the single-row centerline system which led to a U.S. centerline system but only after many years. This was the form favored by U.K. and various aviation groups for quite some years. An older version sponsored by ALPA lacked condenser discharge lamps but a newer one contained flashing lights and that has remained a constant feature over the years. The older U.K. Calvert system also underwent change: the five transverse bars were reduced to three bars.

Further complexities were created by various manufacturers through their diverse designs. Westinghouse designed neon fixtures and flashing strobe lights for approach lighting as separate units (Westinghouse flashing lights were filled

with krypton gas and created a flash of as much as 3.3 billion cp; Sylvania were of xenon gas; Brightest Lights 1949, 127; see also Centerline Tests 1950, 50). While Sylvania combined both in a single fixture. AGA created a funnel shaped system of steady-burning neon fixtures in contrast to CAA's funnel system or slopeline system which displayed groups of sealed beam lamps; groupings of such lamps continue to be used in approach lighting. Line Material/Bartow system created groups dual sealed beam lights in two lines with four rows of fixtures for the outermost thousand feet then three rows for the next segment followed by two and ending with a single row near the threshold line. The left line of lights displayed green lights and the right side red lights; this suggests the pattern employed in marine channels.

During the time of the experiments at Arcata and other places, the Aeronautical Board (members from CAA, CAB, Air Force, Navy, ALPA, and ATA) established an approach lighting system (Army Air Force/Navy/Civil Landing Aids Experiment Station 1949, 96-153). This system called for a row of red lights left of the extended centerline. It is not clear from the literature how long this system was to be in use since other experiments were also in progress. Military airports were to have two rows of lights: one to be red and one to be orange.

Runway lights were originally semi-flush but these were gradually phased out in favor of elevated lights. By 1948 a diverse group of elevated lights were available for runway lighting. Bartow and Line-Material promoted a narrow and "controllable beam" light fixture while most other makers focussed on high

powered, wide beam units that had the side effects of glare and a halo effect. Kroger notes that L-M centered on agility through the controllable beam while the others centered on using brute force through high intensity beams (Kroger 1948, 18, 21). Eventually semi-flush lights were to be reintroduced for inpavement usage. Runway lights were white in color and were of several intensities. References for runway lights include Brightest Lights 1949, 127, New High Intensity Light 1947, 167; Breckinridge 1955, 13-14, 16; Pilot's Guide, 1944, 76, and the already mentioned Kroger.

Other light concerns included threshold and TDZ areas. ALPA's approach lighting schema of 1949 gave a prominent role to threshold lights. And IATA recommended special threshold lighting in 1950. TDZ lighting was included in the Arcata plan for 1949. Slope ... 1948, 16, Brightest Lights 1949, 127, ALPA ... 1949, 40, and Moore 1950, 52 are the sources for this topic.

Radio aids did not follow altogether new directions in this time. The U.S. radio ranges continued though they were first threatened and then overtaken by the VOR system (Wilson 1979, 217-235 TISRP). The CAA was well along with VOR development by 1944 but it was not until 1950 that the first unit was online. The war effort slowed down considerably the development and application of the omniranges. By 1952 nearly 400 VOR installations were in service. The ILS concept existed well into the early 1930s. But the war again delayed its use. A lengthy controversy with the military retarded the acceptance and installation of ILS but eventually the ILS with its several components

dominated the approach phase of air navigation. DME development gradually moved to joint status with VOR by 1951.

International cooperation is rooted in the early days of aviation. The first major conference was held in Paris in 1910 and resulted in an early air law code. Aviation concerns were included at the Paris Peace Conference in 1919. Aviation concerns were assigned to a Aviation Commission (whose origins are found in the Inter-Allied Aviation Committee, 1917) (European ICAO).

This early cooperation led to the International Air Convention (officially termed the "Convention on the Regulation of Aerial Navigation", 1919) which eventually would be ratified by nearly forty nations (European ICAO; Hudson, 1931, 359-360ff TISRP). This was the first full-scale convention on aero navigation; though the Paris Peace Conference included provisions on navigation. But the Convention seemingly gave scant attention to navigation aids. There are references to radio communication but seemingly these had little to do with radio navigation aids. A single reference to visual aids is found in the Convention (Chapter IX, Article 35 (b)). A series of Protocols between 1920 and 1929 does not approach visual aids either. It is conceivable that ICAN went beyond the specific provisions of Convention and Protocols and addressed visual aids more thoroughly. A listing of other agreements (up to 1930) do not indicate evidence of an inclusion of navigation aids either. The agreements in question included both general participation and bipartite forms (List of International Agreements ...).

The Convention dealt with all aspects of civil aviation and led to the establishment of the International Commission for Air Navigation (ICAN). The Commission added a Secretariat in Paris and after the creation of ICAO the offices of the Secretariat housed the European quarters of ICAO for nearly two decades (European ICAO, "ICAO & Forty Years of Air Navigation in Europe").

An event of greater significance for aviation and aero navigation aids is the establishment of the International Civil Aviation Organization (ICAO) and its predecessor the Provisional Civil Aviation Organization and the International Civil Aviation Conference in the 1940s. The U.S., upon requests from U.K. and Canadian governments, called for an international conference in September of 1944 that lead to the formation of PICAO/ICAO. Principal sources included Henry Ladd Smith 1950 and **Proceedings of the International Civil Aviation Conference.**

The conference began on November 1, 1944 and ended on December 7 of that year. A great deal of disagreement between the participants, specifically between the U.K. and U.S. occurred; some of which became acrimonious. Progress was virtually nonexistent for weeks. On December 2, an Air Transit agreement was signed and that signalled the end of paralysis: within five days several other documents were completed. These included Appendix I, Interim Agreement on International Civil Aviation; Appendix II, Convention on International Civil Aviation; Appendix III, International Air Service Transit Agreement; Appendix IV, International Air Transport Agreement. Appendix V included 12

technical annexes which were to become part of the Convention at a later date.

Most significant was the International Convention on International Civil Aviation. Provisions included air transport, navigation, technical matters and included provisions for setting up ICAO. Three years were available for ratification. In the meantime work continued under the Interim Agreement on International Civil Aviation which had established PICA0. In many ways the agreement was similar to the Convention but narrower in scope. The major event after the ending of the Conference was the revision of Appendix V including navigation aids. PICA0 had an interim assembly, interim council, three principal committees and a secretariat. In 1946 PICA0 adopted U.S. radio standards as its own. ICAO began existence in its own right in 1947.

ICAO includes 15 annexes to the Convention on International Civil Aviation. Those important for this study are Annex 10, Aeronautical Telecommunications, and Annex 14, Aerodromes. The appendix of this study takes up a review of navigation aids and their changes from the late 1940s to the present.

Epilogue

U.K. had a centerline approach system in the 1940s known as Calvert (E.S. Calvert was principal scientific officer at the Royal Aircraft Establishment; worked on centerline and crossbar lights, also taxiway lighting and runway markings; see Four Honored 1951, 19). ICAO came to an agreement in 1952 on a centerline system and established a standard for

that system. Work on centerline systems was well underway in the U.S. in the early 1950s including much of the design work and necessary equipment. But it was not until the late 1960s that the U.S. had an officially agreed upon and functioning approach light systems. A truly incredible misadventure marked every stage of fumbling U.S. efforts. Older French system consisted of a left-hand row of lights 100' offset of the centerline (CAA Withdraws 1950, 15).

In 1951 it was noted that U.K. had long had a centerline system and U.S. pilots favored that approach. Tests of ideas took place over and over again. In 1951 the tests were at Patuxent Naval Air Station. International conferences twice took place during 1951. The problem was four-sided: U.S. Air Force, U.S. Navy, CAA and the civil airline pilots. CAA had already given up slopeline and waited agreement from the other three groups. Navy still wanted slopeline while the pilots wanted centerline. The Air Force forbade any centerline for the first 1000 feet from the end of the runway; they would allow an extension of red runway edge lights within that zone. It was thought possible that order out of chaos might be achieved during 1951; similar optimistic statements were repeatedly made over the years. A compromise seemed possible with centerline at civil airports and a modified version at Air Force facilities. This imbroglio blocked international acceptance of an approach light system (New Hope 1951, 16).

In 1952 the situation was unchanged. More evaluation resulted in strong pilot support for centerline and dissent from the military. CAA remained indecisive even though the evaluation

of pilots was conducted by the CAA. ICAO was due to take up the centerline question in 1952. Nothing had changed from previous evaluations, testing, and attempts at reaching agreement (Pilots, ATA 1952, 75-76).

According to **AW**, technical representatives agreed on centerline at ICAO 1952 though the general membership had yet to vote. Supposedly the U.S. military withdrew opposition to centerline approach yet the impasse went on. Though ICAO sources indicate that a standard for approach lighting was adopted in that year (Centerline Lights 1952, 14; Airports 1953, 23).

1955 led to no agreement but it did lead to more tests. This time at McGhee-Tyson air base at Knoxville TN. It was thought that the stalemate could be resolved. A 3000 foot centerline system was the focus of the tests. Both centerline and one of 3000 foot length recur in the literature year after year as often as reports of no agreement occur (USAF, CAA Test 1955, 131).

In 1956 an approach light system known as "U.S. National Standard Configuration 'A'" was installed at Idlewild Airport. It had a single cross bar and was inferior to the later March experiment. Strobe lights were a prominent feature of this system (termed Electronic Flash Approach System or EFAS). The National Standard consisted of two patterns in 1955: "A" with a 3000' centerline and "B" with a 2000' centerline (USAF, CAA Test" 1955, 131).

More tests were conducted in 1957. These took place at March Air Force Base in

California. Much of the focus was on flashing strobe lights though the tests were important for a more basic matter: USAF finally permitted centerline lights close to the end of the runway. This seemingly opened the way to approval of a centerline system. The March tests also included the curious red approach edge lights which gives the inner 1000 feet a three-pronged appearance. The March configuration increased usage of cross-bars (termed roll-bars at that time) (Christian 1956, 96-97). Two components to this lighting system: Sylvania Strobeacons and "Elfaka Flush Lighting"; the latter consisted of concrete boxes with metal grids set into the runway pavement with Sylvania or GE lamps set inside. These units were also employed for threshold lighting (older threshold units were fewer in number and more difficult to identify) (USAF Pilots ... 1957, 117). The Dutch firm Elfaka's approach contrasted with a British idea utilizing a iron hood over an inset light fixture (CAA Will Test 1956, 34).

Captain R.C. Robson, in a column known as "Cockpit Viewpoint", spoke on "The Same Old Story" in February of 1959. A friend and 64 others had died in the crash of a Lockheed Electric shortly before. Robson thought that pilot error would be the official version of the cause but he blamed inadequate visual aids and in particular an adequate approach light system. 1959: the issue is not yet settled (Robson 1959, 43).

IES Lighting Handbook in 1966 spoke of approach lighting systems and of "standard approach lighting configuration." The standard system was a centerline system with one cross

bar and it could exhibit flashing lights. But it does not appear to have been an officially sanctioned and agreed upon system though it was substantially closer to that state (IES 1966, 21-7 to 21-9). By the 1972 edition approach lighting in the U.S. had taken on its familiar and current appearance (IES 1972, 21-6 to 21-9). FAA documents suggest 1969 was the beginning of an official documented system though alterations were on occasion made (FAA 1969; FAA 1974).

CHAPTER 34

THE CLASSIFICATION

34A Main Classification & Explanatory Notes

34A1 Introduction

The main classification is largely based on publications of ICAO. The accompanying variant classification in Ch 34B will include variants of markings in the main classification, and markings from other standards (FAA and NATO augmented by national and manufacturers' resources). The classification has been easier to construct and less complex than that of **International Railway Signals** (Part F) since that study was built up from many sources as railway signals - contrary to aero aids - lacked an over-arching central source of information.

There is a danger in saying that Part G's classification is simple and easy of construction since such an attitude can lull one into overlooking variant and nuanced forms. Even the forms that are included do not include requisite details and qualifications. Those omissions are addressed by explanatory notes and the variant classification.

The classification of Part B, (2nd ed) truncated some forms of navigation aids when those aids shared a common lamp apparatus. For example, Medium Intensity Runway Edge and Threshold/end and Taxiway lights employ the same fixture (#3232 in that classification). While

that approach has some merit (it recognizes that a single form of marking may have multiple functions) it is questionable in that a specific form of marking has - to employ a biological term - both physiological and morphological dimensions. One apparatus, when used for different functions, is not identical. The message is not the same, and the means for creating and projecting that message has to be at variance. Therefore, in this classification, separate entities serving different functions with nearly identical physical equipment will be regarded as separate in the main classification.

Classification nomenclature can be an unwieldy and cumbersome process: it is nearly impossible to fully root out errors and oversimplifications. That can be seen very clearly in the meaning of "partially-lighted" when applied to marine aids to navigation, and aero navigation aids. Partially-lighted follows the literal meaning for marine aids: an aid partly-lighted and partly unlighted. For example, a harbor light has both a lamp apparatus but it also has a daymark; both are essential though the light may eclipse the day portion.

But for many aero aids there is no day portion (obstruction aids are an exception) that is an integral part of the marking. Aero lights are complete in themselves, and nearby markers, pavement markings and signs are separate aids. Partially-lighted therefore means a light burning part of the time instead of an aid displaying both a lighted and unlighted aspects.

The explanatory notes are relatively brief for this classification. The presence of a primary source reduced the need for extensive

notes as was the case with Part F which lacked such a source. The variant classification and its note (Ch 34B) and Chs 35-37 augment the material of Ch 34A.

34A2 Main Classification

- 31 All-lighted
 - 310 Approach Lights
 - 3100 High Intensity Unidirectional Elevated Lights
 - 3101 Medium Intensity Omnidirectional Elevated Lights
 - 3102 Capacitor-discharge Lights
 - 3103 Helicopter Approach Lights
 - 311 Final Approach Indicators
 - 3110 VASIS
 - 3111 3-Bar VASIS
 - 3112 T-VASIS
 - 3113 PAPI
 - 3114 HAPI-PLASI
- 32 Partially-lighted
 - 320 Runway Inset (Inpavment) Lights
 - 3200 Threshold Identification Lights
 - 3201 Edge Lights
 - 3202 Threshold Lights
 - 3203 End Lights
 - 3204 Centerline Lights
 - 3205 Touchdown Zone Lights
 - 321 Taxiway Inset (Inpavment) Lights
 - 3210 Taxiway Centerline-straight Lights
 - 3211 Taxiway Centerline-curved Lights
 - 3212 Taxiway Centerline-intersection Lights
 - 322 Runway & Taxiway Elevated Lighting
 - 3220 Runway Edge Light
 - 3221 Runway Threshold Light
 - 3222 Runway End Light
 - 3223 Taxiway Edge Light

- 3224 Holding Position Light
- 3225 Stop Bar Lights
- 3226 Stopway Lights
- 3227 Clearance Bar Lights
- 3228 Helicopter Final Approach & Take-off Area Lights (Edge)
- 3229 Helicopter Touchdown & Lift-off Area Lighting Systems (Edge)
- 323 Beacons
 - 3230 Aerodrome
 - 3231 Identification
 - 3232 Heliport
- 324 Obstruction Lighting
 - 3240 Low Intensity
 - 3241 Medium Intensity
 - 3242 High Intensity
- 325 Indicators
 - 3250 Wind Indicators
 - 3251 Landing Direction Indicators
- 326 Parking & Docking Aids
 - 3260 Aircraft Stand Manoeuvring Guidance Lights
 - 3261 Visual Docking Guidance System

Special Dual Classification For Signs:

- 32 Partially-Lighted & 33 Unlighted Aids
 - 325/330 Illuminated & Non-illuminated Signs
 - 3250/3300 Mandatory Instruction Signs
 - 3251/3301 Information Signs
 - 3252/3302 Aerodrome Identification Signs
 - 3253/3303 Aircraft Stand Identification Sign
 - 326 Helicopter Colocated Aids
 - 3260 Aiming Lights & Markings
- 33 Unlighted Navigation Aids
 - 330 Runway Markings
 - 3300 Runway Designation Marking

- 3301 Runway Centre Line Marking
- 3302 Threshold Marking
- 3303 Fixed Distance Marking
- 3304 Touchdown Zone Marking
- 3305 Runway Side Stripes
- 331 Taxiway & Other Markings
 - 3310 Taxiway Centerline Marking
 - 3311 Taxiway-Holding Position Marking
 - 3312 Taxiway Intersection Marking
 - 3313 VOR Aerodrome Check-Point Marking
 - 3314 Aircraft Markings
 - 3315 Apron Safety Lines
- 332 Helicopter Markings & Markers
 - 3320 Winching Area Markings
 - 3321 Identification Marking
 - 3322 Mass Marking
 - 3323 FATO Marking/Markers
 - 3324 TD Markings
 - 3325 Heliport Name Marking
 - 3326 Helideck Marking
 - 3327 Taxiway Markings
 - 3328 Air Taxiway Markers
- 333 Markers
 - 3330 Unpaved Edge Markers
 - 3331 Stopway Edge Markers
 - 3332 Snow-covered Runway Edge Markers
 - 3333 Taxiway Edge Markers
 - 3334 Taxiway Centre Line Markers
 - 3335 Unpaved Taxiway Edge Markers
 - 3336 Boundary Markers
- 334 Obstruction Markings
 - 3340 Patterns
 - 3341 Sphericals
 - 3342 Flags
- 34 Electronic Navigation Aids
 - 340 Fully-Integrated Systems
 - 3400 Localizer, ILS
 - 3401 Glide Path, ILS
 - 3402 Marker Beacons, ILS

- 3403 Azimuth Station, MLS
- 3404 Elevation Station, MLS
- 3405 Distance Measuring Equipment (DME),
MLS
- 341 Independent & Partially-Integrated
Aids
 - 3410 VOR
 - 3411 DME
 - 3412 Loran-A
 - 3413 Consul
 - 3414 Non-Directional Beacon (NDB)
 - 3415 En-route VHF Marker Beacon

34A3 Explanatory Notes

31, All-lighted. Approach and Final Approach lights are on at all hours. They are not partially-lighted aids in contrast with most aero navigation aids. Approach lights, 310, are in three forms: 3100, unidirectional high intensity form light; 3101, omnidirectional medium intensity light; and 3102, the capacitor-discharge flashing light which carries out several functions.

Approach lighting is something of a problem in that ICAO does not speak of high intensity unidirectional and medium intensity omnidirectional fixtures for approach lighting. Yet, according to ADB, Thorn and Slo-Idman those characteristics are found with ICAO sanctioned approach lighting and therefore they are included in the classification.

Final Approach Indicators 311, encompass a variety of lights with overlapping functions and divergent names that include several key words: indicator, visual, slope, path, descent, glidepath, glideslope. Many of these are found

in the Variant Classification. A core element is the VASI or Visual Approach Slope Indicator, 3110, which is becoming obsolescent; only the parent form is in this classification. The T-VASIS is included in Main rather than in Variant because it follows a substantially different primary coding principle and yet retains official status for ICAO.

PLASI, or Pulse Light Approach Slope Indicator, is a U.S. developed aid that has nevertheless found employment in a variety of nations (FAA 1988 A/C 150/5345-52; see also Devore 1991). So far, it is not included for ICAO approved aerodrome operations. But a version, HAPI-PLASI, 3112, has been so approved by ICAO. It is a variant of HELI-PLASI a configuration of PLASI. The other PLASI forms are in the variant classification since they lack ICAO status.

32, Partially-Lighted. This has a somewhat different meaning than in marine aids. Aero lights of this form lack a day dimension; the day indication is a separate aid. There are six divisions in 32: inset (runway, and taxiway), elevated, beacons, obstruction lights, wind indicators, and parking and docking aids (lighted signs are handled separately)

The classification is simple to the point of the basic divisions of types of lights, but then complexity develops: landing aids, runway lights and taxiway lights encompass a variety of functions but many of the lights are very similar and some forms are identical. Since this classification focusses on the physical rather than on messages the point of differentiation will be that of the physical. Since landing aids are related to runway

functions they are part of runway categories. There are many forms of inpavement (inset) lights so that taxiway and runway forms have been placed in separate though adjoining categories. Elevated forms are fewer and therefore runway and taxiway lights are united.

Categories of aviation (Category I, II, III) and light intensity (which is, to some degree, a reflection of category) affect the light equipment of 320, 321 and 322 but not this classification. The variant classification and Chapter 35 will include the factors of category and intensity.

ICAO offers many substantial information on approach and final approach lights. But material on beacons, by contrast, tends toward the sparse and restricted to salient points only. ICAO speaks of a single beacon but in practice there are higher and lower intensities and designs are affected by this fact. But a single category is sufficient for Main. As a result a wide latitude in beacons forms, - especially aerodrome beacons, 3230 - is possible. At least two manufacturers have produced a beacon in the shape of a square box and the beacon of another manufacturer bears a resemblance to a giant alarm clock. This latitude restricts this classification, and also that of the variant classification as well since the classification becomes either vague or burdened with minutiae. The identification beacon, 3231, is closely related to the old U.S. code beacon and that design is agreed upon by various makers to a considerable degree. The design of the heliport beacon, 3232, demonstrates the same consensus among manufacturers.

Obstruction lighting, 324, judging by trade literature shares points of design. The simple low intensity form, 3240, appears to be of a nearly universal shape. Medium intensity, 3232, follows the code or identification beacon form or a newer capicitor-discharge design which appears similar to many river and harbor light design. High intensity, 3233 forms are similar in design which is that of a shallow metal box displaying linear flash lamps.

322, Inset Lights. ICAO employs the terms inset or surface lights. U.S. practice termed these semi-flush at one time but has changed that to inpavement lights. NATO employs inset but also includes semi-flush and even blister lights. Ulmer Aeronautique presents a curious form known as "semi-buried" ("semi-encraste") which have the shape of the inset form but are slightly above ground. Ulmer refers to inset forms as the buried or encastre form. Inset is retained as a second term in the main classification. Pollock speaks of full-flush and semi-flush (Pollock 1990, 38). ITTE adds a nuanced meaning by referring to lights placed in the runway (but not along the edges) as in-runway lights (ITTE 1962).

"Indicators" is a common term for aero aids though it can prove to be a difficult one to define. It often refers to aids that have a precise nature and aids requiring a precise response. For example, final approach indicators, a fully-lighted aid, requires a very precise and narrowly focussed response from an aircraft pilot. This segment, however, refers to aids that are not fully-lighted and may not be lighted at all. There is a problem of classification for these indicators, 325, since one element can be either lighted or unlighted

though more often it is lighted while the other element can be lighted or unlighted with the unlighted version a fairly common form. The former refers to the wind indicator, 3250, and the latter refers to the landing direction indicator, 3251. The situation is akin to that of signs. For this classification both are listed as partially-lighted aids though an unlighted version can not be ruled out.

326, Visual Parking & Docking Guidance systems includes two very different systems and both are included in the main classification. 3260, Aircraft Stand Manoeuvring Guidance Lights, 3260, display standard inset taxiway ways. Visual Docking Guidance System, 3261, displays alphanumeric and graphic symbols. They are included together since they have similar functions. VDGS is also present in the variant classification.

32/33, Special Dual Classification. In an attempt to resolve the issue of signs that are sometimes partially-lighted and sometimes fully-unlighted a dual approach is proposed here that resides on/crosses the boundary between partially-lighted and unlighted. This acknowledges the special situation engendered by signs but does not try to resolve it by deciding which are partially-lighted, which are unlighted, which can be either or both.

Non-sign markings are of four general types. The first type, Markings, 330/331 are, to a substantial degree in a paint medium. The markings frequently display stripe and band configurations; though some are in alphanumeric forms. Traffic control devices pavement markings are closely allied to these aids. Markers, 333, are multidimensional and most have

a vertical aspect. The one exception is that of Taxiway Centerline Markers, 3324, which are low-level aids jutting only slightly above the surface. Helicopter markings & markers, 332, is a relatively small area yet a complex one. Some abbreviated and conflated categories have been included for this general classification.

Obstruction Markings, 333, include both one dimension and multi-dimensional forms are in use. These diverse aids are connected by a shared function: denoting obstacles to navigation. Some are in a paint medium while others take on the form of spheres or flags.

34, Electronic Navigation Aids. This classification centers on individual transportation markings. However, many electronic aids are parts of systems and the individual aids are subsumed under the system's identity: ILS and MLS. ILS encompasses traditionally name aids, 3400, 3401, and 3402. However, ICAO includes MLS functions rather than names of aids; this also the practice of manufacturers. Some sources give the specific names including Pierre Condom (*Interavia* 1985, 879-881). MLS aids are designated 3403, 3404, and 3405.

Independent and Partially-integrated aids includes a diverse group of radio aids. Loran-A, 3412, and Consul, 3413, are marine both in foundation and in sponsorship but they are included here because of inclusion by ICAO. NDB, 3414, and the En-route VHF Marker Beacon, 3415, are airport aids as well. These specific versions are away from the airport area and can be regarded as separate aids since they have divergent functions.

34B Variant Classification & Explanatory Notes

34B1 Variant Classification

31 All-Lighted

310 Approach Lights & 311 Final Approach Lights

.1 Light Fixtures/Functions/Systems: Approach & Final Approach

.10 Approach Light Equipment

- .100 High Intensity Unidirectional Lamp (Halogen)
- .101 High Intensity Unidirectional Lamp (Par 56)
- .102 Medium Intensity Omnidirectional Elevated Lamp (Halogen)
- .103 Medium Intensity Omnidirectional Elevated Lamp (PAR 38)
- .104 Low Intensity Omnidirectional Elevated Lamp (Halogen)
- .105 Omnidirectional Flashing Lamp
- .106 Unidirectional Flashing Lamp

.11 Flashing Lights By Function

- .110 Runway Threshold Identification Lights (RTILS)
- .111 Runway End Identification Lights (REILS) Omnidirectional
- .112 Runway End Identification Lights (REILS) Unidirectional
- .113 Runway Identification Lights (RILS)
- .114 Runway Alignment Identification Lights (RAILS)

- .12 Approach Lighting Systems: ICAO & NATO
 - .120 Simple Approach, ICAO
 - .121 Precision, Category I
 - .122 Precision, Categories II & III
 - .123 Type I, NATO
 - .124 Type II, NATO
 - .125 Simplified Type, NATO
- .13 Approach Lighting Systems: U.S. FAA
 - .130 ALSF-I
 - .131 ALSF-II
 - .132 SSALSF
 - .133 SSALR
 - .134 ODAL
 - .135 MALSR
 - .136 MALSF
- .14 Final Approach Equipment: Color Coding:
 - .140 APAPI (2-Color/1 Proj)
 - .141 H-PAPI (2-Color/1 Proj)
 - .142 Mini-PAPI (2-Color/1Proj)
 - .143 AVASIS (2-Color/2 Proj; 4 versions;)
 - .144 SAVASIS (2-Color/2 Proj)
 - .145 3-Bar AVASIS (2-Color/2 Proj)
 - .146 CHAPI (Tri-Color/1 Proj)
 - .147 Glide Path Indicator (Tri-Color/1 Proj)
 - .148 T-PASI (Tri-Color/1 Proj)
- .15 Final Approach Equipment: Pattern, Pulse & Alignment Coding
 - .150 AT-VASIS (Pattern)
 - .151 PLASI (Pulse)
 - .152 HELI-PLASI (Pulse)
 - .153 HAPI-PLASI (Pulse)
 - .154 Optical Localizer
 - .155 (Alignment of Elements, Partially-lighted)

32 Partially-Lighted

321 & 322 Runway & Taxiway Lights; 323 Beacons;
324 Obstruction Lights; 325 Indicators

.2 Light Fixtures: Selected

- .20 Taxiway Inset (Inpavement) Lights
 - .200 Straight Sections & Caution Bars (Other than Category III) (Bi/Uni)
 - .201 Straight Sections & Caution Bars (Category III) (Bi/Uni)
 - .202 Intersections (Other than Category III) (Bi/Uni)
 - .203 Intersections (Category III) (Omni)
- .21 Elevated Lights
 - .210 Runway Edge (VFR)
 - .211 Runway Edge (NP IFR)
 - .212 Runway Edge (P IFR)
 - .213 Threshold/End (VFR)
 - .214 Threshold/End (NP IFR)
 - .215 Threshold/End (P IFR)
- .22 Beacon Lights
 - .220 Medium Intensity
 - .221 High Intensity
- .23 Obstruction Lighting,
 - .230 Incandescent Bulb/External Lens - Low Intensity (L.I.)
 - .231 Incandescent Bulb/Internal Lens - L.I.
 - .232 Mercury Bulb/External Lens - L.I.
 - .233 Neon Tube/No Lens - L.I.
 - .234 Fresnel Double Drum Lens - Medium Intensity
 - .235 Multi-Cold Cathode Tubes & Reflectors - M.I.
 - .236 Strobe Light, Helical - M.I.

- .237 Strobe Light, Linear Flashtube - M.I.
- .238 Strobe Light, Linear Flashtube - Double Unit - M.I.
- .24 Docking Systems
 - .240 Numeric, Signal & Graphic form
 - .241 Alpha, Signal & Graphic form

3. Vertiport Lighting & Markings

- .300 Identification Beacon
- .301 FATO Lighting
- .302 TLOF Lighting
- .303 Identification Markings
- .304 TLOF Markings
- .305 FATO Markings

34B2 Explanatory Notes

Approach Lighting proves to be an especially complex subject. There are many configurations and possible variations for ICAO alone and differences outside of ICAO can be even more extensive. The variant classification is intended to focus on physical differences in equipment. Yet approach lighting equipment can frequently be similar though great differences in configurations and terminology can be present. For those reasons this variant classification takes up approach lighting apparatus that may differ by terminology or use even if not by physical characteristics. Much of the variant classification is given over to approach lighting. That coverage is divided into .10, Lamps and lampholders; .11, flashing lights by function; .12 approach lighting systems for ICAO and NATO; and .13 approach lighting systems for the U.S.

The many light units (lamp and lampholder) at an airport represent only a few kinds of

light fixtures. And the differences in light units may often not be that significant. Nonetheless the various forms of fixtures, types of lamps, functions and systems are all included here. ICAO technical specifications are less detailed than national specifications since they encompass broad requirements and they center on characteristics of fixture and lamps and on colorimetry expectations. Therefore, the catalogues of manufacturers have had a role in this coverage since they translate ICAO standards into concrete descriptions and images. This is true for all forms of aero lights and not merely approach forms.

RTIL (110) and REIL (111) (and presumably RIL, 112, as well) belong together. They are flashing lights flanking the threshold lights. But ICAO places RTIL with runway related lights while the FAA places REIL with approach lighting; NATO's RILs also appear to be with approach lighting. RAILS (113) are flashing lights situated below the starting point of Medium Intensity Approach Lighting systems in the U.S. RTILs are unidirectional only but REILs and RAILS can be omnidirectional as well. All of these lights, some unidirectional, some omnidirectional are closely allied though use and designation may create a contrary impression.

Approach lighting systems are closely integrated systems choreographed according to structured rules. The various systems are included in this variant classification because they have great bearing on the physical apparatus and because a fuller comprehension of the apparatus and messages can be gained through knowledge of the systems. Segment .12 includes ICAO and NATO forms. NATO and ICAO each have

three forms and they bear strong resemblance to one another.

ICAO Precision Category II & III (124) has two possible configurations: barettes (light bars) or individual light fixtures. When the later is employed there is a triangular shape created since the various rows of light fixtures decrease toward the runway threshold while barettes have the same number of lights in each row. The barette form seems far more common.

U.S. FAA, .13, approach light systems may seem at sharp variance with ICAO and NATO systems. However, the variation may not be all that much. All of the systems are centerline in form and bear considerable resemblance toward one another. The names and acronym do project distinctly different images. U.S. Medium Approach Lighting System (MALS) is similar to Category I rather than the ICAO's simplified system. There is in fact no comparable U.S. system to the simplified system. Halogen lamps are commonplace in many systems though PAR 56 continue to find considerable use. PAR 38 continues to dominate in the U.S.

The coverage of final approach indicators is at variance with the usual Explanatory Notes format. There are many forms of these indicators. In many instances no longer employed forms contribute greatly to currently employed forms. Indicator forms, both new and old, exist under a thick covering of acronyms that have become interwoven with the indicators. Final approach indicators are divided into two segments: .14 for color coded forms (individual forms are marked for number of colors and number of projects), and .15 for pulse, pattern and alignment forms. A description of the workings

of various glide slope indicators is to be found in Cook's review of landing aids development (Cook 1960, 108-110). Some case can be made for Slopline to be considered as an indicator. See Approach Light Systems 1950, 46-47.

Two-Color and Single Projector units include PAPI, APAPI and H-PAPI. PAPI is assigned to the Main Classification. APAPI, .150, (first A in APAPI designates Abbreviated) has two light units instead of four and displays three messages instead of five: too low, correct path or high (PAPI has two low messages: quite low and slightly low and two high messages: quite high and slightly high). H-PAPI, 151, has the messages of APAPI but in a different configuration: the light units are at the end of the landing area flanking the centerline instead of alongside the runway area.

Two Color and Multiple Projectors include VASIS, AVASIS, SAVASIS, 3-Bar VASIS and 3-BAR AVASIS. VASIS is in Main as well as 3-Bar AVASIS (ICAO includes that aid with VASIS and PAPI as principal forms of final approach indicators). AVASIS, .142, forms are on one side of the runway and have from two groups of one light each to two groups of three lights each. U.S. configurations for VASIS are at variance with those of ICAO. The U.S. standard patterns more adequately conform to AVASIS standards while variant patterns include both VASIS and AVASIS forms. SAVASIS, .143, appears to be closely allied to an ICAO two fixture AVASIS of reduced power. 3-Bar AVASIS is designed as .144.

Tri-color aids provide a degree of uncertainty: one can speak in generic terms or resort to specific terms which are brand names

or nearly so. T-PASI, .148, (Danaid) and Glide Path Indicator, .147, (Cegelec) are single projector and single unit aids. CHAPI, .146, (Crouse-Hinds) is a single projector but multiple unit operation. The first two display colors of yellow, green and red. CHAPI displays white, green and red indications. All three have precision optics.

Pattern Coding consists of T-VASIS and the variant form of AT-VASIS, .150. T-VASIS is found in Main. TVG (T-Visual Glide Slope) was the Australian name but ICAO designated it as T-VASIS. It retains official standing unlike VASIS. RT-VASIS or Reduced T-VASIS was an attempt to reduce the system to six boxes on one side of the runway (AT-VASIS has ten boxes on one side) but that attempt was not successful.

Pulse Coding offers an alternate to PAPI though for more restricted usage. ICAO has not approved it for aerodromes but one version is approved for heliports; that formed is termed HAPI by ICAO and HAPI-PLASI, .153, by Devore Aviation the sole manufacturer. An earlier version, HELI-PLASI, .152, displays white/green/red messages while HAPI-PLASI has yellow/green/red messages. The core form at present is that of PLASI, .151, (Devore Aviation). Glide Angle Indicator Light (GAIL) and Visual Approach Path Indicator (VAPI) are older pulse code aids.

Alignment Coding, .154, has had a long history in final approach indicators. Possibly the only such system in use is that of GLISSADA from Russia. An Alignment of Elements system is a day system that can be enhanced for night use with lights. AOE is therefore either a partially-lighted or unlighted system and apart

from fully-lighted forms. MDLA (Mirror Deck Landing Aid) is an older form of alignment coding. FLOS (Lens Optical Landing System), Poor Man's Optical Landing Aid (POMOLA) and Double Bar Ground Aid (DBGGA) are variants or derivatives of MDLA.

There are other many forms of final approach indicators. Some are largely terminological phenomena, some are variant forms, yet others are defunct forms while still others have contributed features to newer and extant forms. Visual Glide Path Indicators (VGPI) and Angle of Approach Indicators (AAI) contributed to TVG which eventually was termed VASI. What has been termed Tri-Color VASI is a generic term rather than specially a VASI system; it encompasses the three-color, single projector aids (GPI, etc).

Terms such as Pulse Code Optical Landing Aids (PCOLA) Optical Projector Ground Aids, and Generic Visual Descent Indicators (GVDI) are overarching terms more than specific indicator form. GVDI is the FAA designation for indicators for general aviation and includes VASI (two projectors) and PLASI forms (one projector).

ICAO refers to different situations for runway and taxiway lighting (curves, straight sections, exits) but does not mention various types of lighting to meet those needs. Neither does NATO whose coverage is similar to that of ICAO. The U.S., in marked contrast, has a great mass of detail on variant forms of runway and taxiway lighting. For that reason the coverage for runway and taxiway, and these notes, focus on the U.S. situation. Not all forms of runway and taxiway lighting requires inclusion in this classification since some forms lack significant

variant types. Taxiway inpavement lights are listed under .20 and elevated lights (runway, and threshold/end are designated as .21.

Obstruction lighting has three levels of operation with a variety of types of apparatus for each level. National standards may narrow the range of design but ICAO standards are directed more at optical capabilities than the physical design of the device with the end result of light units of diverse appearances. The variant classification now encounters a problem: if the classification is predicated on optical abilities then it obscures the physical designs but predicating the classification on the ingenuity of manufacturers can result in a bewildering range of designs. The variant classification has attempted to answer this dilemma by incorporating key elements of optics and designs augmented by appropriate notes. All obstruction lights are subsumed under .23.

The American model of the basic fixed, low intensity obstruction light varies little from maker to maker: its overall dimensions are often little more than 5" in diameter and 7" in overall length (including lampholder), it is of glass and has a Fresnel type of lens as part of the globe; there is usually no dome over the lens. This model employs an incandescent globe. European makers frequently offer this model or one similar. But they also offer many other and distinctly different forms as well. Some models are somewhat similar with more muted changes: an egg-shaped globe instead of one that is cylindrical or a clear dome over the lens or a partial lens. The basic form is designated as .230; an internal lens form becomes .231. And a form with partial lens and mercury lamp is listed as .232. Differences in shape of the

globe or lens were not deemed sufficient to warrant a separate number.

Many European forms are radically different. These are often employ neon tubing (a form of cold cathode tubing), they may be elongated, often without any lens, they may even be attached directly to a power line. Some forms have a similar glass dome surrounding the neon tubing. Mercury lamps have also been employed in some instances. All of the neon obstruction lights are listed under .233 though further differentiation may be justified.

Medium Intensity forms traditionally have employed what is frequently termed the code beacon: a double cylindrical drum in the Fresnel mode with an incandescent bulb for each part of the drum lens. This unit, designated as .234, in red, continues to find considerable use in many parts of the world. But other forms of medium intensity have been developed. These are frequently strobe lights with helical flashlamps and are very similar to marine aids to navigation lights. They are omnidirectional with a white flash tube. Cegelec has produced an additional medium intensity form: a unit utilizing neon tubes, .235, coupled with anodized reflectors;

A new form of medium intensity obstruction light, .237, uses multiple linear flash tubes with reflectors creating omnidirectional coverage. The older flashtube light, .236, employs a singular helical flash tube for achieving omnidirectional coverage. A variant form, .238, has two sets of linear bulbs/reflectors with a double cover: one part clear and one part red. This approach eliminates a separate traditional red beacon for

night use. High intensity beacons are all of the strobe lamp variety and do not require coverage in the variant classification.

Beacons for airport identification project an uncertain image since they perform a role from through different designs and equipment. In a brief study the only distinction may be between medium intensity, .220, and high intensity, .221. The high intensity forms, whatever the design employed, are found at major airports and display powerful lights. Medium intensity units, with a variant form at heliports, are somewhat smaller in design and power. Many medium intensity forms have two or three separate lights in one unit while high intensity have a single and integral apparatus.

Docking systems are elsewhere included with Runway and Taxiway forms due to functional similarities. But they remain a separate entity in equipment. One form, .240, employs numbers, standard signal lamps and graphic symbols but no words while the other, .241, omits number forms but includes words in conjunction with signal lamps and graphic symbols.

Vertiport Lighting and Marking is included here because it originates with U.S. FAA not ICAO. The classification presents only the general forms of these aids. Ashford & Wright 1992, 470-473).

34C Pictorial Representations
34C1 Illustrations

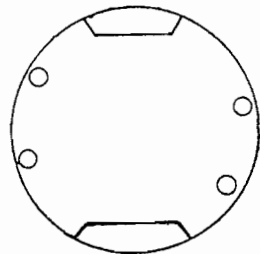
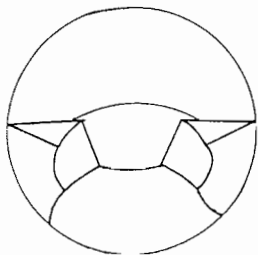
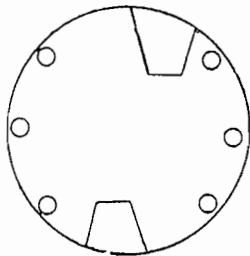
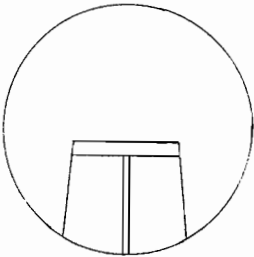
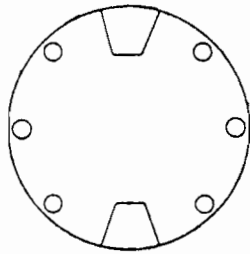
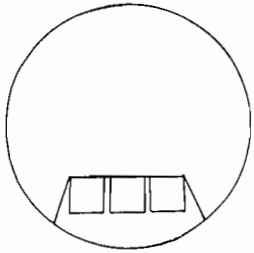
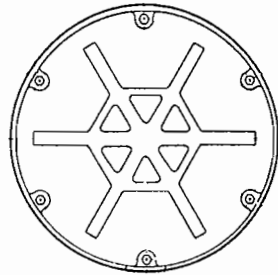
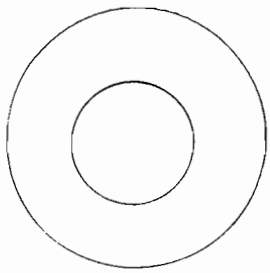

Inset Forms

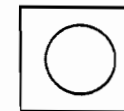
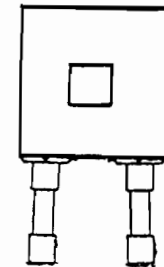
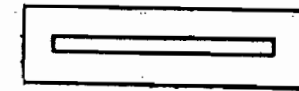
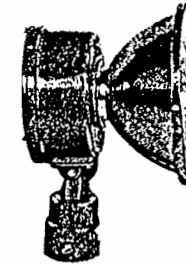
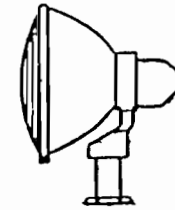
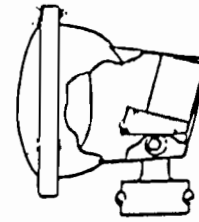

Approach & Final Approach Forms

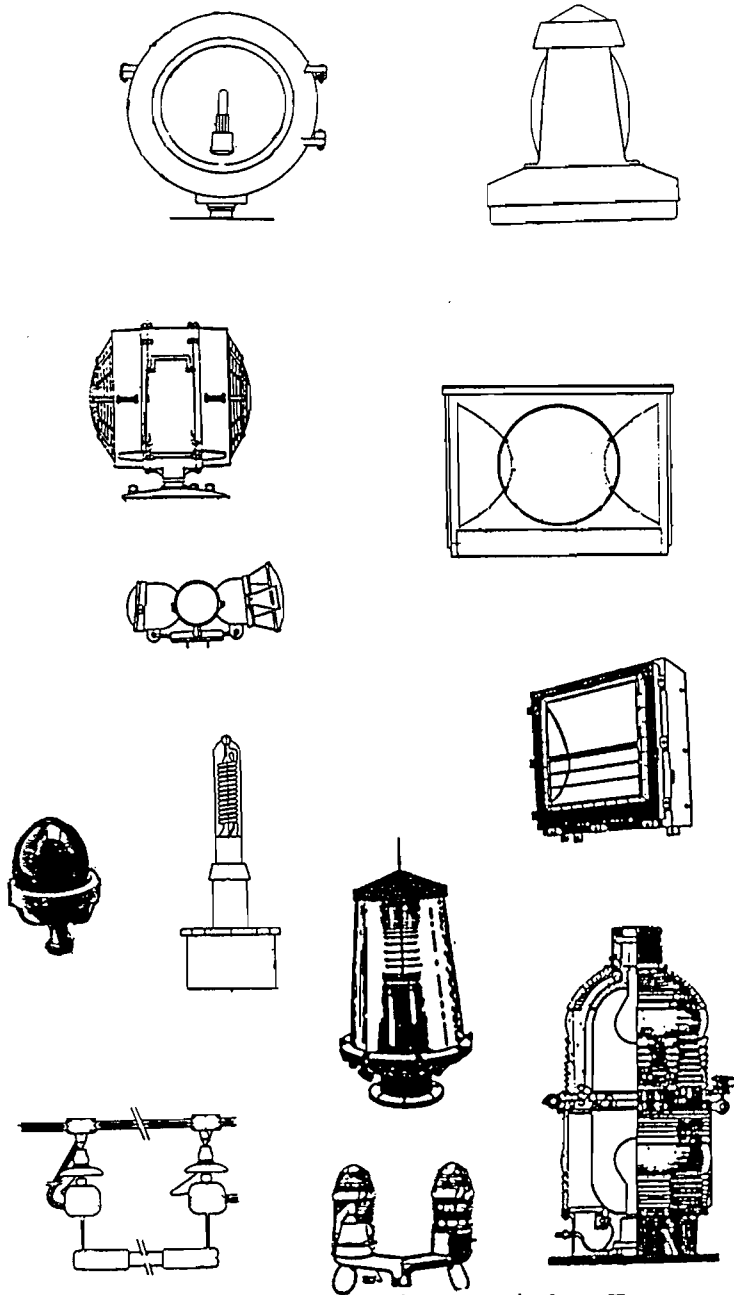

Beacon & Obstructions Light Forms

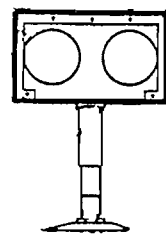
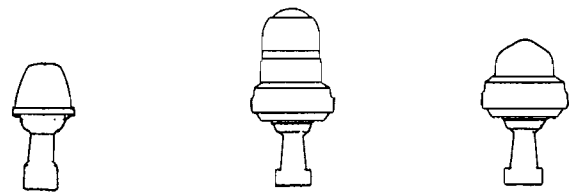
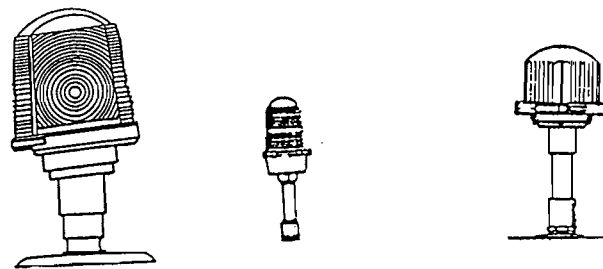

Runway and Taxiway Light Forms

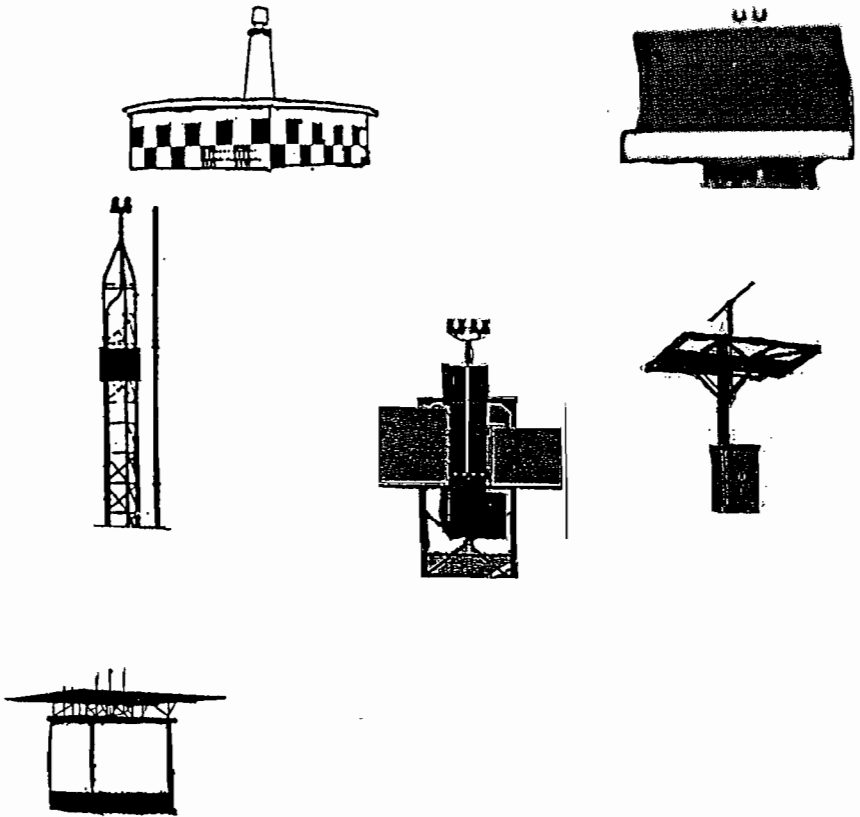

Radio Aids

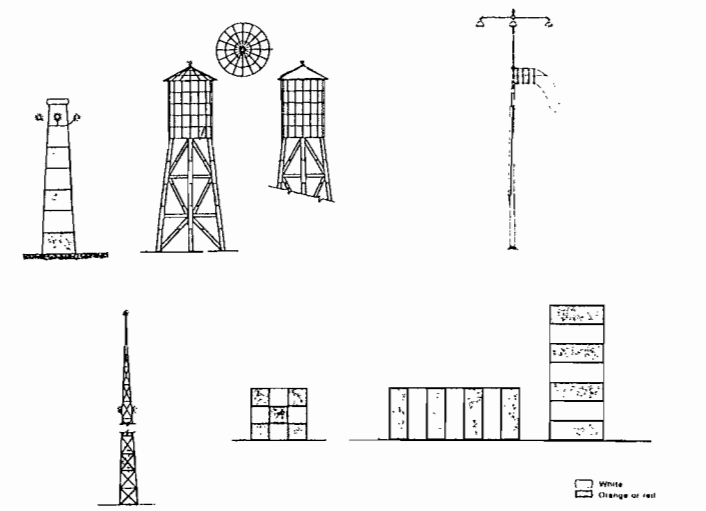

VOR 116.3 147° VOR 116.3 147°

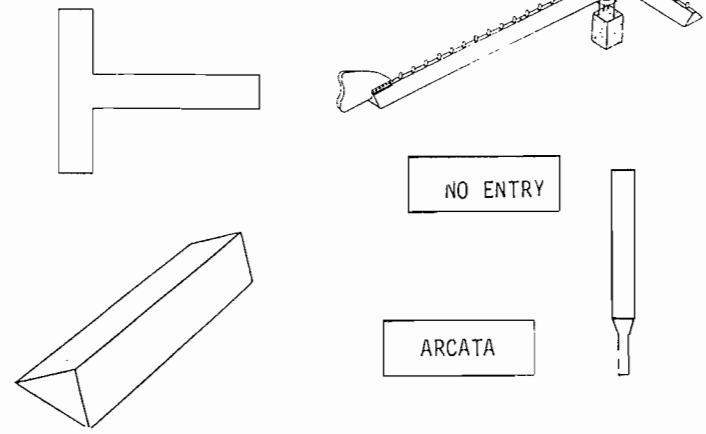

Signs and Markings

34C2 Explanatory Notes

Instantly recognized aero aid forms are probably the exception not the rule. This is due to several factors: international standards which are less detailed than national standards, changes in optics, expansion computer technology, and new developments in plastic, glass and metal. Hence the illustrations in 34C1 and these Notes can only be representative within restricted bounds. Older forms were often identical or at least substantially similar, but this is now less often the case. The Notes cannot cover all cases because of the brevity of the study. Nonetheless, Chapter 34C presents a preliminary illustrated introduction to the topic of aero aids.

Inset forms can be divided into three types: omnidirectional, bidirectional and unidirectional. Omnidirectional types are represented by two forms: a simple form with a clear glass center (top left, graphic representation; see Idoman, Cegelec, ADB, among others) that radiates light in all directions and a more substantial form (top left, Crouse-Hinds) that can bear up under weight and which throws light energy from a segmented lens.

Multiport lens continue to be common from European (ADB, Idoman) manufacturers though less so in the U.S. Only one of the manufacturers represented in this study offers a triple-port light (upper left central). That is Thorn Europhane and the light is employed for approach and threshold lights. Doubleport lens are commonplace and may be either bidirectional or unidirectional (left lower central). They may, depending on maker and function, be shallow or

deep units; they may also be wide or narrow. Two illustrations display singleport units. One is offset and that seemingly is found only with Crouse-Hinds (right upper center). The wide yet shallow unit (bottom right) represents lens openings that may be on the edge of the housing as well as those set in slightly from the edge (patterned on Crouse-Hinds inset light). The remaining unit (bottom left) is designed for taxiway lighting on curves has been modelled on Idman.

The double-ended rotating beacon (left upper center) marked many airports for many years but has been superseded by a variety of forms (patterned after ADB form, right upper center). The illustrations partly represent those forms. Some makers have produced a beacon that revolves and has a nearly square shape. This has approved by ICAO. Both ICAO and FAA approve of a lower intensity beacon (left center) that has two or more light units in a single apparatus. One U.S. maker (Crouse-Hinds, top left) has produced a beacon bearing a visual resemblance to an alarm clock and one has produced a somewhat more conventional design for higher intensity needs in the U.S.

Obstruction lighting for many years centered on two forms of beacons: the code beacon (bottom right) and the small fixed incandescent light (bottom center). Both forms continue in use and are found in many nations. The illustration of the simple, fixed light is a double unit. Other forms have been added. Some of these are strobe lights and have found nearly universal usage. They include both high intensity (right center) and medium intensity (lower center) forms. Europeans have been especially inventive with

obstruction lighting; many of these involve neon tubing. A common form is elongated with spherical tubing (left of lower left center, ADB) and one form (bottom left) is directly tied to overhead power lines. An egg-shaped form has been included because of its distinctive shape (left lower center, Cegelec). It can include either incandescent or fluorescent energy source. Forms not pictured included a medium intensity unit that displays circular neon tubes and a cylindrical form with linear neon tubes. One manufacturer has created a medium intensity strobe unit (EG&G) containing both red and white lights.

Many older elevated lights were either cylindrical (top left, from Westinghouse a former major aids maker) or a more complex shape centering on a Fresnel lens. More and more variant forms are in use and many display some form of dome. The illustrations include the formerly widely employed high intensity light unit. This continues in use in some systems (according to Crouse-Hinds) and some makers (for example Crouse-Hinds and Thorn Europhane) continue to make it. The short cylinder form is more common for high intensity use now (top right, Godfrey Engineering). Some forms are a true cylinder (for example, ADB) though the one illustrated has a curved top. Others are closer to a dome form. Some makers offer separate fixtures for low/medium intensity use though others have a single elevated fixture that contains various options in color filters and light source wattages.

The center rows displays three more contemporary designs for medium intensity. They include a true dome (left lower center, Tesla)



two variant domes (left upper center, Idman; right upper center, ADB) and one that hestiates between dome and cylinder forms (right lower center, Cegelec). A variation of (dark image) is high intensity. Cegelic uses dome designs for all forms of elevated lights. The bottom light is a taxiway holding position or stopway light Crouse-Hinds). A second form bears a strong resemblance to a standard traffic signal (ADB).

Approach light units may be similar in appearance whether halogen or PAR forms. Nonetheless, a representation of each form (left top, EG&G, right top, Cegelec) is included. Simple approach light systems utilize omnidirectional fixtures. Some of these are elongated cylinders while others display shorter, more squat cylinders; the form included is of the former type (left upper center, ADB). Flashing lights are either omnidirectional or unidirectional; (upper center, Multi-Electric, right upper center, Godfrey). The unidirectional model clearly displays both light and strobe unit. Other forms can have variant forms.

Final approach indicators picture include (front view only) VASI (left lower center, stylized graphic representation), PAPI (left lower center), PLASI (right lower center, partially stylized representation and one three-color form (left bottom stylized representation based on Danaid). T-VASIS is similar in frontal appearance to that of VASIS and is not included. Because light units are inside the housings these representations portray less of the aid than is true of most other aid representations.

Signs, Markings, and Markers represents a large and diverse field. Markings can become meaningless when viewed in small segments. Therefore markings are omitted from the pictures but they are represented in their larger context of an airport operation in Chapter 36.

Signs represent three major categories. Mandatory instruction signs are represented by a No Entry sign. Information signs are represented by a VOR check point sign in two forms: light letters on a dark background for a day-use sign and black letters on a letter background for an illumination version. The aerodrome identification sign is obviously not according to scale since the letters need to be at least 3 meters high (107 inches).

Obstruction markings are represented by both larger and smaller objects. Taxiway edge markers are represented by a elongated marker; a second form consisting of a cylinder on short mast is found in Part B. The triangular shaped object in lower left hand corner serves both as unpaved runway edge and boundary markers.

The upper right hand corner contains a typical wind come with illumination. A landing direction indicator is found in the left lower center position. To the right of that is a wind tee. This is not found in ICAO and is no longer standard in FAA but they continue in use and various manufacturers continue to offer them.

ICAO was the source of most of these illustrations. FAA supplied wind cone and wind tee. And the taxiway edge marker was influenced by ADB.

Electronic aids are less significant in a visual mode but they are to a muted degree present in that perspective. The left images are of a VOR, Glide Slope and Marker Beacon/ Compass Locator facilities within ILS. The center and right representations are of one form of localizer, glide slope and marker beacon facilities within MLS. Tull Aviation substantially influenced the MLS images.

CHAPTER THIRTY-FIVE

LIGHTED AERONAUTICAL NAVIGATION AIDS

35A Approach Lights

35A1 Introduction

Pre-landing lighted aero aids include two forms: approach lights and final approach indicators. They can be studied as separate entities though they are obviously related. This subchapter focusses on approach lights while 35B takes up final approach indicators.

The character of many aero lights (fixed or flashing, color, intensity, direction of beam) substantially defines many aero aids. The configuration is important though it often completes what was established by the character of the light. For example, runway edge lights display a specific pattern but the color and other factors shape that configuration.

Approach lighting seems to reverse the process: the complex and diverse configurations themselves substantially establish the environment of these aids. The colors are important but they almost appear subsumed into patterns; patterns which are beyond simple and unvarying rows of lights.

The following segment will take up the equipment for these aids. Messages, including configurations, occupy a second section.

ICAO publications are vital to this discussion though they do not give substantial information on the equipment. Operational

00000 00000

Category I, II/III Approach Lights

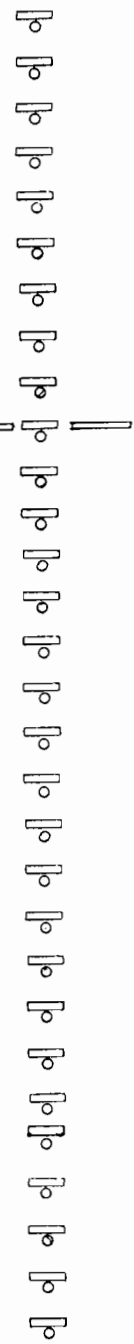

Simple Approach

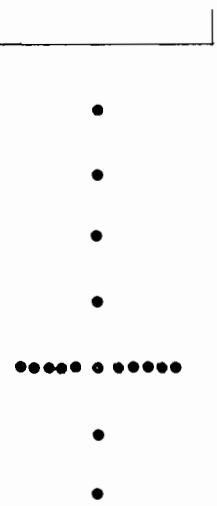

Category II/III inner 300m

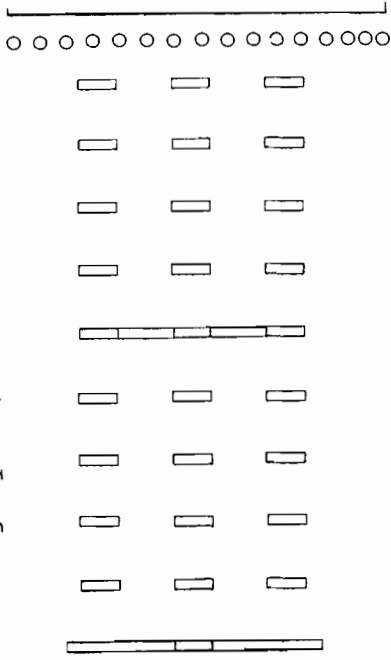

Figure 1. Left, Right-Top, Right-Bottom



standards (including those of NATO, and the U.S. FAA), manufacturer's literature, and other sources provide vital supplements.

35A2 Approach Light Equipment

Approach light systems have many components. The components can be reduced to a elementary bifurcation: fixed lights and flashing lights. Fixed lights, for ICAO, have in turn two major divisions: high intensity lamp units employing standard PAR lamps or halogen lamps, and lower powered omnidirectional light units for simple approach systems. Halogen cycle lamps is the general name for a lamp family known by many names including quartz, quartz-iodine or tungsten-halogen lamps. They are incandescent lamps using iodine or bromine as a fill gas. They render colors well, and provide a high intensity of light from a limited source. PAR lamps or parabolic aluminized reflector lamps are in two segments: the reflector is molded and coated with aluminum. The lens is also molded and imprinted with the desired pattern. The filament is precisely positioned into the lamp so it is at the central point. The lens is then welded onto the reflector base (Lindsey 1991, 43, 41). Some systems, including that of the U.S., have a medium intensity unidirectional approach system instead of the omnidirectional simplified system of ICAO (FAA 1974, Chs 1-7). Flashing lights (capacitor discharge; older sources frequently speak of condenser discharge) are of a single type performing a variety of functions.

The principal light unit is a unidirectional light displaying a Halogen or PAR 56 lamp. Some systems with unidirectional medium intensity

systems may employ a PAR 38. The housing is quite likely to be aluminum with stainless steel hardware. Necessary color filters are also part of the unit. The support for this light can be of several forms: a short coupling with base plate; a section of conduit; or a frangible mast possibly set on a multi-dimensional framework. Some approach lights are of the inset form. These are similar to other inset lights; color conforms to that of approach lighting.

There can be several intensity levels for approach lighting. There are levels both for daylight and night operations since approach lighting is a fully-lighted aero navigation aid. FAA also has abbreviated forms of approach lighting for better visibility conditions. The short form exists for high intensity (Category II/III versions). ADB includes mention of abbreviated forms though seemingly ICAO does not. ICAO (Attachment A, ICAO 1990) includes intensities but in more general terms than other sources (FAA 1974, 16).

The second principal form of approach lighting is that of the capacitor discharge light. This light can have one several functions. The most common type uses a PAR 56 discharge light within a housing similar to that employed by other PAR 56 lamps. The lamp unit is accompanied by a supply cabinet containing controls, timer, flasher trigger, and power supply. There are both both omni- and unidirectional forms. There is also an inset form of the discharge lamp.

There are other uses of flashing lamps though they are more commonly associated with FAA than ICAO. Lead-in Lights are listed in

ICAO but the information in the **Aerodrome Manual** is a reprint of U.S. (ICAO 1983, 4-65/66). This light is employed where there is an uncertain or hazardous route to the airport. The lights may follow a curved, straight or irregular route. The flashing light in question is a capacitor discharge light.

ICAO speaks of a Runway Threshold Identification Light (RTIL) which is also flashing. These are identical with Runway End Identification Light (REIL) though the later is associated with approach lighting rather than runway lighting (FAA 1974, 3-4). Some REIL units are omni-directional. Omni-directional lights make up one form of approach lighting system under that name. Some REILs are also omnidirectional. ICAO seemingly does not employ omnidirectional flashing lights except for obstacle lighting. Flashing lights are frequently are attached to the supply cabinet which is, in turn, attached to a base plate by a coupling (See Multi-Electric, Godfrey, ADB & other manufacturers).

35A3 Messages for Approach Lights

From one vantage point messages are extremely simple for approach lighting: they are either red (where side rows exist) and white lights (centerline) are flashing or steady burning (red are all steady burning). The simplicity ends there as well. Configurations, levels of aviation operations, variable intensity levels combine to create a complex situation. But a complex situation that upon examination reveals clearly established patterns (ICAO 1990, 48-51, TIRSPS).

Category II and III are in effect a single level of operation; Category I is a simpler level. Category I approach lighting is 900m in length. The length is divided into three equal segments of 300m. At the end of the first third a crossbar runs across the extended centerline of lights (if individual light units instead of barrettes or light bars are employed there are other crossbars at 150, 450, 600 and 750m). The crossbar is 30m in length with the lights 1-4m apart. The centerline lights are 30 m apart and are fixed in character with variable white color. One light per group for inner 300m, two in middle 300m and three for outer 300m. If barrettes are used instead they are accompanied by flashing lights for all three segments. The barrettes are 4m in length.

Category II/Category III configuration is also 900m in length. There are crossbars at 150m and 300m from the threshold. Barrettes are employed for the inner 300m; barrettes appear to be first choice for middle and outer 300m segments though two-light and three-light patterns are acceptable as a substitute. Flashing lights accompany middle and outer barrettes. There are obviously many points of similarities with Category I. The most notable difference is the existence of a row of fixed red lights flanking the innermost 270m of centerline lights. The rows are comprised of barrettes.

The simple approach light system is 420m in length. There is a crossbar 300m from the threshold which is either 18m or 30m in length. Spacing of centerline lights is 60m. Either individual lights or barrettes may be employed. The lights are fixed and of a color that can be

distinguished from other nearby lights. Sequenced flashing lights can be added for the outer part.

Flashing messages for sequenced flashing lights for ICAO are 120 flashes per minute; FAA and some manufacturers have flash rates from 60-120 per minute (FAA 1974, 16-17). ICAO does not mention intensity levels for flashing lights though ADB and U.S. sources do. Flash intensities can be a single level or three levels. Multiple levels are required if flashing lights are to be employed during times of greater visibility. The color is that of a "xenon discharge lamp" (FAA 1981, 4) which is within the range of color known as variable white. This color is termed "aviation variable white by ICAO and "variable-source white by U.S. Standards, Breckinridge 1967, 48).

35B Final Approach Indicators

35B1 Introduction

With other forms of aero aids a single form of light can sometimes be used to perform a variety of functions (various runway and taxiway lights provide examples of shared fixtures for multiple purposes). Final approach lights represent the reverse situation: a single function is performed by a wide assortment of lights. This requires a complex explanation situation both for the historical development of these aids and for the present aids. A vignette of their history is found in Chapter 33B; this coverage focusses on equipment and messages. Clark & Gordon (1981) and Clark & Antonenko (1993) have written important essays on final approach indicators.

Messages will be considered first since more sense can be made of the diverse apparatus after some understanding of purpose and messages is achieved. There are so many different versions of these indicators that an attempt at a master listing has been compiled. This is found in the Variant Classification: current forms in the actual classification and past forms in the explanatory notes.

The purpose of these indicators (whose titles often include combinations of certain key words: slope, path, descent, indicator) is to provide descent information for an airplane approaching a runway. The many kinds of indicators have a core element in common: they denote whether the angle of approach is on course or too high or too low. They may also

distinguish between very low and slightly low and between very high and slightly high.

35B2 Messages for Final Approach Indicators

This coverage of messages for final approach indicators has two dimensions: a review of the range of signal coding forms, and the actual message configurations of the indicators. Clark and Gordon (1981, 5-6) provides a comprehensive over review of signal coding. Signal coding can be initially divided into primary and secondary coding. Primary coding is the most important, and may possibly be the only form of coding. Secondary coding, when present, supplements or augments the primary coding.

There are as many as eight forms of coding in current use; variant forms may also be employed. The various codings may be primary in some instances and secondary in others. This coverage has been greatly influenced by Gordon and Clark (1981). These include "directional shielding" though that term does not appear to fully describe a coding situation in which the message is partly lighted and partly dark (such as a harbor light) or wherein the light is seen only if the pilot and aircraft are in a specific location in relation to the indicator (for example, T-VASIS).

A second form is intensity coding in which various directions have correspondingly different intensities of light. These include T-VASIS (TVG in Australia but renamed T-VASIS by ICAO) and one type of Red/White VASIS employed that approach. Flash coding is a third form (PLASI incorporates flashes or pulses though color is also present). Pattern coding, a

fourth form, is associated with shape and symbol as one form (T-VASIS noted for use of pattern). A fifth form is that of position coding which Clark and Gordon see as part of Pattern coding. Alignment coding, the sixth form, is primary coding for several older forms (Slopeline, MDLA, FLULS, PVG, Glissada) and presumably pertains to Alignment of Elements mentioned in U.S. sources Slopeline described as a guide path by SNL (New Lighted Guide Path 1948, 371); does that constitute a looser definition of the term or was Slopeline considered to manifest features beyond a modern definition of guide path indicators?. Little information is available for movement coding, the seventh form. Finally, color coding, the eighth form, is quite commonly employed (R/W VASIS, PAPI and others).

There are five major forms of messages for final approach indicators in current use (though variant forms may also be employed): VASI, T-VASIS, PAPI, PLASI, and Tri-Color. VASI, the long-enduring standard indicator, is to be phased out relatively soon. The colors for VASI messages are white, white/red and red. Three-Bar VASI, a variant form, a separate explanation. Color coding is primary for VASI.

An all-white message denotes that the aircraft is above the approach slope. Red/white denotes the aircraft is on the approach slope; red only indicates aircraft is below the desired level. A transitional zone of pink can exist on the margins of the red and white sectors. The lights for VASIS are fixed in character for day and night operation.

VASI in ICAO parlance is a 12 light system. The 12 lights are arranged in groups of four

units with three lights in each unit. The upper units are termed upwind bars while the lower units are downwind bars. The wingbars flank the runway with the downwind bars 150m from the threshold and the upwind bars 210m beyond the downwind units.

AVASI (or abbreviated VASIS) has four forms: two groups of two lights flanking each side of the runway; two groups of three lights flanking the left side of the runway only; two groups of two lights on the left side; and two groups of a single light unit on the left side. The message configurations follows the pattern of VASI though with fewer lights.

3-Bar VASI is comprised of a VASI configuration plus a two-light unit on each side of the runway. The additional units are termed upwind bars and the upwind bars of VASI becomes the middle bars. Because of the additional bar there are two possible glideslope approaches. If the approach is to be between the downwind and middle bars the correct approach is denoted by white indications from the downwind bars and red from middle bars and upwind bars. If above the glideslope the indication is red from upwind bars and white from downwind and middle bars. If really above the glideslope all bars show white. If below then the indication is red from all the bars.

For an approach between middle and upwind bars the desired approach is marked by white lights from downwind and middle bars and red by the upwind bar. An all white indication denotes the aircraft above glideslope; a below-glideslope position is marked by a white indication from the downwind bar, and red by

middle and upwind bars. An aircraft far below the glideslope receives an all red message. Spatial configurations are those of VASI with the additional bar 210m above the middle bar.

T-VASIS utilizes pattern as primary coding with color in a secondary role. T-VASIS is comprised of twenty light units flanking the sides of the runway. There are two wing bars with four light units each located at approximately the midpoint of the runway and perpendicular to it. The wing bars are 280m from the threshold. Parallel to the runway are three single light units above the wing bars and three below. The single units are 90m apart with those lights nearest the wing bars 45m above and 45m below the wing bar. The lower parallel lights are termed "fly-up units" and the upper are called "fly-down units." There are variant versions of T-VASIS: AT-VASIS, and RT-VASIS. AT-VASIS (Abbreviated T-VASIS) has ten light units. RT-VASIS or (Reduced T-VASIS) has just six units.

Clark and Antonenka provide a clearer visual explanation of T-VASIS than does ICAO. If a pilot is above the approach slope point the lights will appear as an inverted "T" which is akin to a directional arrow on a road. The "T" indicates the pilot should fly-down. The "T" may show a tail with three lights, two lights or a single light depending how far the pilot is above the approach point. If the pilot is below the approach point the an upright "T" is displayed indicating fly-up. Again, the "T" can have a tail of one, two, or three lights. If a pilot is far below the desired altitude a "T" in red is formed termed "gross undershoot signal" which denotes danger.

The VASIS system displays color indications at all times but T-VASIS shows only a portion of the lights at anytime; the remaining lights are not visible except at a specific position. The pattern formed by light (or lack of light) constitutes the message. VASIS indicates whether on, above, or below course. 3-Bar VASI indicates on, above, quite above, or below in one matrix and on, above, below or quite below in the other. T-VASIS indicates three levels of above and three of below as well as on; it also has a far below course indication. T-VASIS has seven indications versus three or four possible messages in conventional VASIS.

PAPI has just one unit: a four-light wing bar on the left side of the runway; APAPI has just two lights. Color represents primary coding for PAPI and APAPI. There are five possible messages: when on approach the two lights nearest the runway are red and the two farthest from the runway are white. If above the approach slope there is one red light (nearest the runway) and three white. If well above the approach slope all the lights are white. Three red lights nearest the runway denote a below the approach slope position. Four lights indicate well below the approach slope. APAPI indicates on approach with one red nearest the runway and one white light away from the runway. An above the approach slope indication consists of two white lights, and below the approach slope is marked by two red lights. H-PAPI is a variant form for helicopter operations. PAPI units can vary in size and in number of lamps. Most are two or three lamp units though Idman has a four lamp unit. Lamp wattage is frequently 200w though some 45w and 100w lamps are available. Thorn Eurothane

produces a small unit termed a Mini-PAPI (PAPI: What the ... 1984, 35).

There are several other approach slope indicator systems in use that are not mentioned in ICAO publications. These include Tri-color systems and Alignment of Elements systems.

Tri-color systems (seemingly they lack the usual acronym) is a one light unit operation. Below approach slope is denoted by red, above approach slope is marked by amber. If on approach slope a green light is displayed. These units date back to the 1930s and are represented by at least two current models: the Glide Path Indicator (GPI) of Cegelec and T-PASI (Tactical Portable Approach Slope Indicator) of DANAIID).

Pulsating systems (usually PLASI or Pulse Light Approach Slope Indicator) also has one light unit. This is a two-color approach based on pulse and color coding. The below approach slope indicator is marked by pulsating (or flashing) red. Above approach slope is noted by pulsating or flashing white; on approach indicator is steady white. One form is approved by ICAO for helicopters but the principal form is not. AIP 1990, 0-3; Devore Aviation 1991).

The Alignment of Elements systems (AOE) is either a day-only or a partially lighted system. It consists of plywood panels painted either fluorescent orange or black and white. Lights may be included for night-time use. There are three panels. When above glide path the middle panel is above the side panels. When below approach slope the middle panel is below the side panels. On glide slope is marked by the

three panels in a straight line. The panels are usually found on the left side of the runway (AIP 1990, 0-3).

35B3 Final Approach Indicator Equipment

VASI units are installed in a metal housing mounted on short legs. The lamp units are two PAR 64 lamps behind a white and red spreader lens; the lens is quite elongated on a horizontal plane. The lamps are mounted in the rear of the unit and the lens is mounted over a narrow slit aperture in the front of the box. VASI units lack the precision optical projectors of PAPI (Multi-Electric 1978). The ICAO **Aerodrome Design Manual** includes a second form of VASI that is a projection type and suggests the PAPI system.

The PAPI system is also contained within a metal housing. The unit is smaller than a VASI unit (about half the size of VASI units though one manufacturer claims their PAPI is one-fourth of their formerly produced VASI units). The unit contains either two or four lamps. The lamp assemblies contain reflector, lamp holder, and quartz lamp. The assembly is mounted in the rear of the box. Beyond the assembly is a red filter, inner lens, outer lens and front glass. It is mounted on three or four legs. The unit is of a precision optical design that presents narrowly focussed and precise light beams. APAPI units are of two lamp design. A full installation has four units with two lamps each; some models though have three lamps per unit (see, for example Danaid 1991, 2-3 Mk.10).

According to the ICAO **Aerodrome Design Manual** presents two types of T-VASIS light units (ICAO 1983, 4-74, 4-75, 4-80, 4-81

TISRPS). The first is termed the blade type. It consists of one basic assembly with three variations. The first variation is the fly-down unit. The light unit, which is located in the rear of the unit, displays a beam that is channeled by a blade above and below the projected light beam. This unit is a white-only version. The wing bar variant adds a red filter in the front of the unit with a blade at the top edge of the light beam. The fly-up unit has a blade below the light beam. There is a red filter above the light beam and in front a blade beneath the beam. The aperture for that unit is quite narrow permitting only a narrow beam of white light and a narrower band of red.

The second form of T-VASIS is of the projection type. The housing contains a lamp assembly containing lamp, filters and projection lens. This unit is similar to one type of VASI system and also suggests features of PAPI.

Only limited information is available on the Tri-color System. It is comprised of one light unit that projects a three-color message. One form, that of T-PASI, is comprised of the housing, halogen lamp, three-color filter, reflector and lens (Danaid 1991).

The PLASI system consists of a single box of somewhat squat yet elongated design on flexible legs. The lamp assembly consists of condenser lens, halogen lamp, lamp holder and red filter. A mechanical device operates the shutter that creates the pulses (Devore Aviation). A variant form of PLASI is the Optical Localizer which projects a horizontal beam rather than a vertical one but the equipment is similar to that of PLASI. This is also a Devore product.

Airport lighting began very simply: boundary lighting encompassing the perimeter of the landing field accompanied by necessary beacons and obstacle lights. Airport lighting has since blossomed forth with many forms of lights. A first glance at airport lighting can seem bewildering since the many lights are of diverse forms with a broad range of messages displayed in contrasting patterns. A further examination, to be begun in 35C2, will illustrate the essentially simple, albeit multi-layered, character of aero aid equipment and messages.

Runway and taxiway area lights can be divided into three segments: Landing aid lights, runway edge lights, and taxiway lights. Landing aid lights include touchdown zone lights and center-line lights. Runway edge lights include not only lights by that name but also runway end/threshold lights (those lights that mark the bottom and top edges of the runway). Taxiway lights include center, edge, exit, intersection models as well as clearance, holding position and stop bar forms.

Runway and taxiway lights are in two forms: elevated and inset (the latter are sometimes referred to as semiflush or inpavement lights). Some lights are either exclusively inset or elevated while others may appear in both forms. The physical dimension (inpavement and elevated) will determine the format of the following coverage with elevated lights in 35C2 and inpavement in 35C3.

Runway and taxiway lights are not in continuously operation and therefore lack a day dimension. That fact requires signs and markings to be in close proximity to the lights in order to supply day aids. Signs and markings are considered in Chapter 36.

Parking and Docking systems are included in this subchapter. Parking lights are inset taxiway lights while docking lights are a multifaceted system employing alphanumeric, graphic and signal lights mounted well above the pavement areas. But they remain closely integrated with runway and taxiway forms and are thereby included here.

ICAO publications are of primary importance in this study but other standards and manufacturing trade literature are incorporated into the coverage. The use of multiple sources may lead to confusion since the sources project disparity in styles and contents. This concern is tempered by the introductory nature of the monograph which may not fully capture either the source material or the problems lurking therein.

35C2 Inset Lights

A division of airport lights can be made according to physical fixture or according to purpose. It may appear more sensible to divide according to purpose (taxiway in one group, runway in another). This compiler has divided according to the less likely principle: fixture. Why? because of the close resemblance between the physical part of the lights. Any other dividing splits very similar equipment and unites very dissimilar units. The message coverage is the better place to unite lights according to

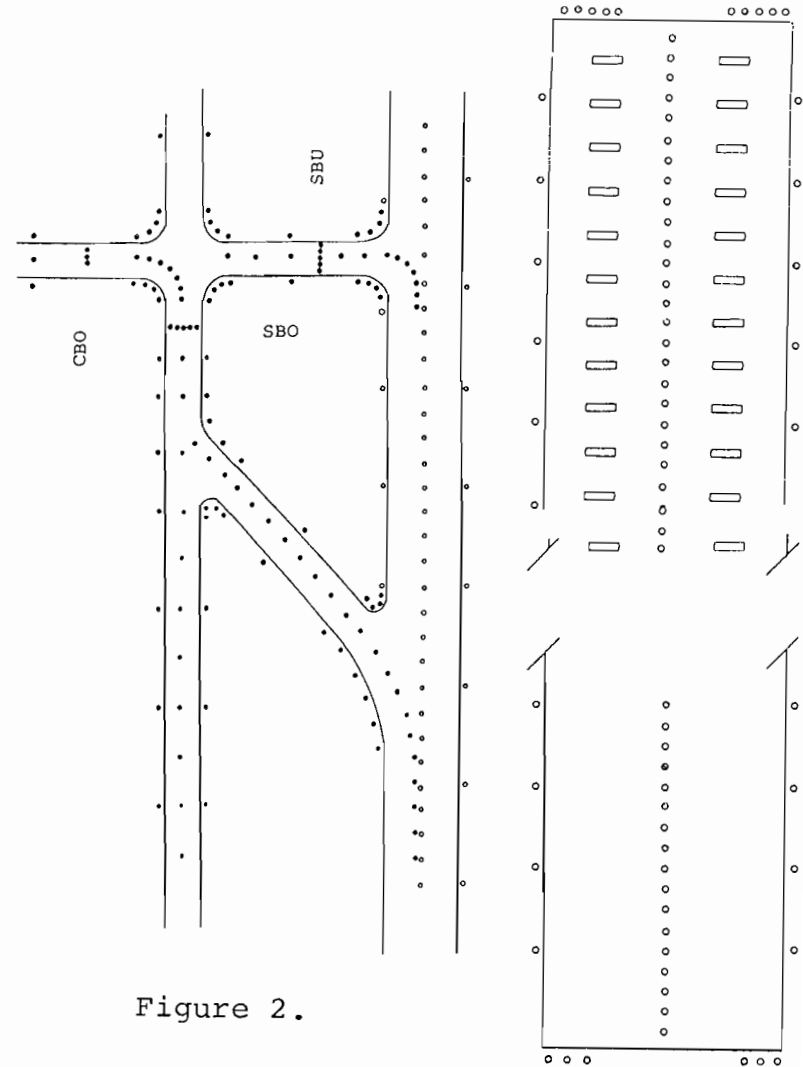

Figure 2.

- LEGEND
- Taxiway
- Clear Circles = Runway Lights
 - Solid Circles = Green Lights (within taxiway boundaries)
 - Solid Circles = Blue Lights (outside taxiway boundaries)
 - Solid Circles = Alternating Green & Yellow Lights (denoted by arrows)
 - Stop Bar Unidirectional (SBU) = Red Lights
 - Stop Bar Omnidirectional (SBO) = Red Lights
 - Clearance Bar Unidirectional (CBU) = Yellow
- Runway
- Threshold = Green
 - TDZ = White (3-light barrette units)
 - Edge = White
 - Centerline = Threshold to 900m from end: White
 - 900m to 300 m from end: Alternating White & Red
 - 300m to end: Red

(This configuration represents a basic pattern; alternate modes may be in use)

Runway & Taxiway Lighting

function; for example, taxiway lights together and runway lights together.

There are three major forms of airport inset lights: runway, taxiway and approach. While most approach forms are outside the paved areas of an airport there are some inset approach lights in use. Inset approach lights are included in the subchapter on approach lights rather than in this segment.

Taxiway lights have a single purpose while runway lights encompass several functions as outlined above. Nonetheless, taxiway lights have variant forms: straight sections, curved sections, intersections, and exits. ICAO standards may be more general, less precise than national standards practices with the result that taxiway lights are not a narrowly designed subject though degree of commonality is present.

The physical apparatus of inset lights varies somewhat according to purpose and manufacturer. Nonetheless, some general comments can be made about the varieties of inset lights. Since the lights are often run over by aircraft they require a strong housing. This housing is often of cast iron which may be plated with cadmium; a nickel-molybdenum alloy may be substituted (users included ADB). Graphite iron is employed by CEGELEC, Omnipol/Tesla employ aluminum alloys; Omnipol/Tesla also uses cast steel. The assembly frequently consists of an outer cover that contains openings for the lens; the lens may be an integral part of the cover. The upper cover is bolted to the lower with a gasket between them to prevent leaks. The lower cover contains optical and lamp assemblies. Lights are frequently quartz halogen. Some outer covers may be set within a metal ring of equal strength. Some

taxiway lights are wide beam while others are narrow beam. Crouse-Hinds speaks of some ICAO taxiway lights as having asymmetrical beams though seemingly ICAO does not mention that form; Philips (now Thorn Europhane) also offers an asymmetrical form. References for this coverage include Omnipol/Tesla, Crouse-Hinds, Cegelec, Idman, Thorn Europhane, and Light Repairs 1989, 34).

The upper covers of taxiway light forms contain a lamp cartridge that can be removed from the surface without removal of the entire unit; a removable metal plate protects the cartridge from damage. Inset lights can be bidirectional, unidirectional or omnidirectional. The last-named may have a domed shaped lens protected by an upward extension of the cover and buttressed by ribs radiating out from the lens. Some forms of inset lights have double lens for each direction; the double lens may be sent into separate window channels.

35C3 Elevated Lights

Elevated lights are more common than inset lights. All airports with lights contain elevated forms though not all have inset lights; for example, what are termed general aviation (non-commercial flights) may have only basic elevated forms). Elevated lights can obviously mean approach lights as well as runway and taxiway forms. Though frequently the term "elevated" refers only to runway and taxiway forms. This may stem from the fact that nearly all approach lights are elevated (with only a few inset forms) and no differentiation is required; lights within paved areas can be numerous in both styles and differentiation is necessary.

In addition, elevated runway and taxiway lights have the configuration of a fully-integrated unit including the support; approach lights and their supports are often separate units requiring two manufacturers. Therefore, elevated lights, unless otherwise noted, refer to runway and taxiway lights in this study.

The high intensity runway edge light requires a fixture exclusively for its use but all other elevated lights can conceivably share a single fixture though this is not always be the case. This can mean that low and medium elevated runway lights for edges of runways, threshold/ends and taxiways may all use the same fixture with necessary changes in lenses and filters. Some manufacturers market a fixture usable only for low intensity edge lighting; one example of this practice is Godfrey (Godfrey ud GEA05). While others follow the multiple-use pattern with one fixture; for example Crouse-Hands, ADB. and the former Philips concern (Crouse-Hinds 1990, BT-1.3 & others: ADB, A.03.150e, Pollock 1990).

An elevated light of wider beam can be employed at thresholds where no approach lighting is available and that fixture is separate from the basic elevated fixture. The holding position light for taxi operations is an elevated fixture of markedly different appearance. It can be a horizontal fixture of two lights on double pipe supports or a two-light vertical fixture visually similar to a traffic beacon. Principal components of elevated lights include lens, lamp assembly, stem, hardware and foundation. Lenses frequently consist of an outer and inner lens (the former is at times referred to as an "outer globe"). The support for the lens unit is known by several terms: conduit post, stem, tube or column. The lamp is frequently quartz or quartz

halogen; some incandescent bulbs are in use as well. Hardware is frequently stainless steel while much of the remaining unit is aluminum. Couplings are frangible since this is an above ground unit. Plastic is sometimes employed for the upper housing. The unit can be affixed to several forms of foundation; stake and base plate are the most common. References include an amalgam of manufacturers; many have been previously described.

35C4 Messages for Elevated & Inset Lights

Messages for aero navigation aids can be a complex and technical matter. The following account is only a summary and should not be employed for actual air navigation. Runway edge lights display fixed (also termed steady burning; ICAO favors fixed while FAA prefers steady burning) lights in variable white. The configuration is comprised of two parallel rows with 60m spacing on instrument runways and 100m spacing on non instrument runways. Displaced runways can be marked with red lights to the point where the runway begins. The last portion of the remote end can be denoted with yellow lights.

Runway Threshold Identification Lights

(termed Runway End Identification Lights or REIL for FAA use and associated with approach lighting; FAA 1974, 63-64). These lights display flashing white lights with a flash rate of 60-120 per minute. They are unidirectional and found near the outer corners of the approach end of the runway. They are two in number and located at noninstrument runways. They are apparently an inset light for ICAO though an above ground unit with lamp and housing for FAA usage.

Runway Threshold Lights are perpendicular to the threshold. They are fixed unidirectional lights displaying green in the approach direction. Noninstrument and nonprecision runways are marked by six such lights. ICAO provides a formula for spacing lights at Category I, and Categories II and III rather than giving an exact number of lights. Wing Bars (found in ICAO but absent from some national systems including the FAA) are groups of lights found at some runways where special attention to the runway is required. They consist of two wing bars or groups with at least five lights in each. They are fixed, unidirectional and green as are standard threshold lights.

Runway End Lights are perpendicular (or at right angles) to the runway end. There are at least six lights equally spaced (or in groups that are spaced symmetrically). The lights are unidirectional and red in color.

Runway Center Line Lights are employed with Category II and Category III operations. They are fixed and display variable white lights from threshold to 900m from runway end. The lights are alternating red and white from 900m down to 300m and solid red for the last 300m.

Runway Touchdown Zone (TDZ) Lights are also employed with Category II and Category situations. The lights encompass the first 900m of the runway and are in two rows of lights flanking the centerline. TDZ lights are in groups (or barrettes) of three lights. The messages are fixed, unidirectional and in variable white. Only in pavement lights are employed.

Stopway Lights follow the edges of the stopway and are "coincident with the rows of the

runway edge lights" (ICAO 1990, 73). They are fixed, unidirectional and red in color.

Taxiway Center Line Lights are not assigned to specific levels of aviation (precision, non-precision, categories) but general guideline exists: if traffic volume is not substantial then edge lights and markings are sufficient. The lights are fixed and green, of the inset form and bidirectional. Green and yellow lights employed at exits according to established formulas. Lights for straight sections are a maximum of 30m apart; there are various special situations and exceptions to that rule. Lights on curved sections can be as little as 7.5m apart. Rapid exit lights are a maximum of 15m apart with various exceptions. Other exits are at most 7.5m apart.

Taxiway Edge Lights are fixed and blue in character. They are also found at holding bays and apron edges. These constitute the basic level of taxiway lighting.

Stop Bars are located at taxi-holding positions according to set formulas. They are 3m apart and extend across the width of the taxiway. They display red lights and manifest a fixed and unidirectional character. The message is one of stop-and-go.

Clearance Bars define holding limits in situations where stop-and-go indications are not required. They display fixed, unidirectional messages in yellow and spaced 1.5m apart.

Visual Parking & Docking Guidance systems are required when aircraft need to be precisely positioned. Terminals without aerobridges employ a system of markings and lights. This approach is termed Aircraft Stand Manoeuvring Guidance

Lights. This system employs low intensity inset taxiway lights with yellow filters. The second system is termed a Visual Docking Guidance System.

Visual Docking Guidance System (VDGS), is a multifaceted aid that denotes the form of aircraft (positioning dependent on that data), distance from docking perimeter and location in relation to docking approach lane centerline. One form displays information through numbers and graphic symbols while a second form employs words and graphic symbols. The first form displays red numerals indicating one of 17 aircraft types (47 for a 747, 07 for 707, 10 for DC10, etc). It also displays three pairs of signal lamps indicating gate clear (green), caution/ 4.5m to dock, and red for stop/at dock. Finally it displays three vertical tubes of which the center is green and the flanking tubes are yellow. When the aircraft is on the centerline the green will be visible; if off center either the left yellow or right yellow tube is visible (ICAO 1983, 4-123, 4-124, 4-125 TISRPS).

The second form is comprised of a single message panel with multiple messages. It displays green lights at the bottom, a series of adjoining lights for much of the length of the panel with three colors: green lights for most of the distance denoting closing distance to the dock then amber lights indicating docking is near and finally red lights indicating stop. Alphanumeric messages at the top of the panel indicate stop followed by either "OK" or "TOO FAR"; the later indicate an overshoot. A narrow vertical line of color indicates on centerline (green) or move right or move left (both yellow).

The primary focus of aviation is on (Conventional Takeoff & Landing) forms but there are other forms including Vertical takeoff and landing (VTOL) (helicopters and tiltrotor craft) and Short Takeoff and landing (STOL).

Heliports have three main elements: final approach and takeoff area (FATO), takeoff and landing area, and obstacle clearance zone. The FATO can be a circle or rectangle and should be at least as large as the rotor area. The second element is a larger area that includes the FATO. Aids include identification markings (white), wind cone, and taxiway centerline markings (yellow). The identification beacon displays white-yellow and green messages. Perimeter lighting (suggestive of older boundary lights) are in yellow. Landing direction (approach) lights are a row of yellow lights. Taxiway lights are blue. Various final approach units are available and are described with CTOL forms. References include Ashford 1992, Ch 14; also FAA 1994, Paragraphs 31, 32).

Vertiports focus on tiltrotor craft but can accommodate helicopters; vertiports can be elongated as well as square. In addition to a FATO, Vertiports have a touchdown lift-off surface (TLOF) and aids center on the later. TLOF is marked by "V" shaped identification marking with and white edge markings. Lights for FATO limits are in blue while TLOF are in amber. Taxiway lights are in blue. Identification beacon is of the heliport pattern. Approach lights can also be present. STOL aviation is akin to CTOL though flying surfaces are more truncated. Primary reference is Ashford 1992, Ch 14.

35D Beacons & Obstacle Lights

35D1 Introduction

This may be a "marriage of convenience" since beacons and obstacle (obstruction: FAA & NATO; obstacle: ICAO) lights are two different subjects. However, the study is brief and separate subchapters would result in two very short segments. Further, many obstruction lights can be regarded as beacons; some obstruction beacons and non-obstruction beacons share the same equipment. Finally, placing non-airport lighting together is not an unknown practice; for example, AIM 1991 (Table of Contents) places these forms together. Separate segments for equipment will be provided in this subchapter though messages will be together. Some forms of airport lighting require precise standards with great amounts of details; examples are approach lights and final approach indicators. But other forms of lights are much less precise and the characteristics are minimal and seemingly a variety of light forms will suffice. This will prove true for beacon and obstacle lights.

The term beacon in marine usage can include all visual aids and at least some electronic aids. Aero usage appears to restrict the term to omnidirectional lights established well above ground level; these lights are also in a flashing mode. The traditional Fresnel beacon employed for obstruction lighting is so regarded by the FAA though seemingly not by ICAO (FAA 1991, 34). It may well be necessary, at least for the sake of simplicity, to refer to all of the lights in this segment as lights with a

subform of beacons for a restricted and specified variety of above ground lighting.

Beacons have a relatively long and colorful history. They are the only part of aero aids that generates any of the interest accorded to lighthouses though only to a muted degree. The history segment of this chapter offers some information on that subject. However, beacons are a small and restricted topic in contemporary aero aids and therefore coverage of that topic is limited. That should not suggest a lack of historic and contemporary importance.

Obstruction lighting is part of a larger topic: marking and lighting of obstructions and obstacles. It includes general principles on the scope of obstacles; the denoting of obstacles both at airports and away from airports; the specifics of lighting equipment and their messages; the specifics of markings and their messages. Light equipment requires a separate segment but since light messages are brief they share a segment with beacon messages. Unlighted obstruction aids will be presented in the next chapter.

35D2 Beacon Lighting Equipment

For ICAO there are three beacon types: aerodrome, heliport and identification beacon; it may be more accurate to view the heliport beacon as a variant form of the aerodrome beacon. Standards for many forms of airport lights are extensive but not for the beacon. There are only a few statements regarding the beacon with the result that wildly different designs have resulted. For example, ADB and Thorn Eurothane have a beacon that is literally

a square box with lamp assemblies in four directions (ADB A.08 230e TISRP; Thorn Europhane, 25). Crouse-Hinds has a two sided form that looks very much like a giant alarm clock (Crouse-Hinds 1992, CT-7.5) while Cegelec has a more conventional design of four circular lens mounted on a square housing (Cegelec).

ICAO simply states that the beacon must flash and that it must follow certain intensity and candela requirements. There are no requirements beyond that. The beacon can conceivably rotate or flash. AIM indicates that a capacitor discharge lamp can be employed for this purpose (AIM 1991, 2-1-7). The ADB and Thorn Europhane version has two clear windows (one in reserve) and two green windows (also one in reserve). The housing is steel and contains parabolic reflectors and displays lamps that are "prefocussed mirrored dome lamps"; Crouse-Hinds speaks of halide lamps.

The code beacon was a mainstay of aero navigation aids for many years. The beacon is all but identical to the Fresnel obstruction beacon and was introduced in the 1930s. The primary U.S. specification was written in 1942 (CAA 1942). But in 1980 the FAA cancelled the specification in favor of a new obstruction lighting standard (FAA 1980). The code beacon was a generic term that encompassed not only hazard beacons but various forms of airport identification beacons (CAA 1942). Despite the cancellation AIP and AIM continue to include the code beacon (AIP 1990, AGA-05; AIM 1991, 2-2-1). The code beacon, now known as an identification beacon, has official standing with ICAO.

ICAO devotes less attention to the identification beacon than to the aerodrome beacon. The beacon is to flash, to show in all directions, and should be visible up to a minimum of 45 degrees above the horizon. The ADB version of the beacon is that of the Fresnel beacon and presumably other versions are akin to it.

35D3 Obstruction Lighting Equipment

There are three levels of lights for obstruction purposes: low, medium and high intensity. There are several forms of low intensity for ICAO (judging by the offerings of selected manufacturers). Probably the most common form made by a number of manufacturers, especially in the U.S., is a simple fixed red light. It consists of a glass cover, often doubling as a lens or containing a lens, surrounding a low wattage lamp, and lamp holder assembly. This light is omnidirectional with red lens; some versions may have a clear lens and red filter. A double form of the light is found in some nations including Canada and the U.S.

A second version of this light, made by ADB, is fixed and red and conforms to cd intensity and omnidirectional character but has a far different means of illumination. The light in question is a "neon discharge lamp emitting a red light." The light is a simple unit with the discharge lamp, lampholder and housing. There is no filter. One form of this light contains only a limited number of spirals; a second has a substantial number of spirals (ADB A.07.220e).

A third version, possibly only made by ADB, is a curious entity termed a "Balisor lamp". It consists of a cold cathode neon-filled lamp, is of low intensity, and feeds off the electrostatic field from a high-voltage power line. It is designed to illuminate power lines which constitute a difficult obstruction to mark. Cold cathodes refers to electrodes that heat to about 200 centigrade; hot cathodes run considerably higher (Laughton 1985, 27/17).

The historic centerpiece of obstruction lights (more precisely beacon) as well as code and identification beacons has been the double barrel-shaped fresnel lens. It has been a mainstay for over fifty years and it continues to be manufactured in many areas of the world including Asia (for example Toshiba), Europe (ADB A.07.270e) and North America (Crouse-Hinds 1962, 301,1).

This beacon has an upper and lower lens which are identical. A steel or aluminum hinges both unites and divides the light. There is a lampholder and lamp for both sections. There is also a lower body or base and various gaskets, rings, hinges. It is a flashing light that is omnidirectional. Some versions are of clear glass with filters while others are of red glass. The flash unit is external to the beacon. Some newer versions employ an electronic flasher that reduces but does not fully shut off the lamp thereby extending the life of the lamp. The Fresnel beacon is of medium intensity.

Developments in optics have led to the capacitor discharge lamp (sometimes known as a strobe light). This lamp can be of several

types and constructions as well as terminology; the later is not always uniform. Some versions of the lamp employ a linear flashtube while others are helical (spiral) in shape. Flashing lights for approach lighting systems are also of this form. The flash is brought about by the master timer actualizing the trigger relay and thereby ionizing the xenon gas within the lamp. This creates an arc resulting in a brief but brilliant flash of light. The power supply or controller contains the equipment for supplying current, timer and other components (Multi-Electric 1974, 2-3 to 2.6).

There are three versions of capacitor discharge (cd) obstruction lights. The most common is one employing a helical shaped lamp. This is a medium intensity unit. It consists of acrylic lens, lamp, lampholder, base and control unit containing timer and other equipment. This is an omnidirectional unit. The light is white in most uses though a red version is seemingly available. Some use is made of this form of light in special marine situations. In fact the light bears a markedly similar appearance to standard river and harbor lights. It produces 20,000 cd during the day and 2,000 cd at night.

A variant form of the medium intensity cd light employs lineal flash tubes. These are a smaller version of those used in high intensity units. This form requires three parabolic mirrors, three flash lamps. The unit becomes omnidirectional because of the three precisely positioned lamp and reflector elements; it does not revolve. This form, produced by EG&G, may eclipse the Fresnel lens because the light can be produced in a dual version displaying both red and white colors in a single unit. The

light does not have a lens system. Both types contain a outer plastic cover but that does not constitute a lens. It produces about 20,000 cd with 160w during the day and 2,000 cd with 30w at night (EG&G 1992).

The first non-incandescent alternative to traditional obstruction lighting was the high intensity strobe light with quartz/xenon flashtubes. The light resides in a simple metal box with glass front. It provides a white light that is unidirectional. The light can produced 200,000 cd and is designed primarily for daylight use; reduced intensity or red lights are employed at night. It produces 200000 cd during the day; 20000 cd at twilight and 2000 cd at night.

35D4 Beacon & Obstruction Light Messages

Beacon messages are quite simple. Aerodrome beacons display white or white/color messages with 12-30 flashes per minute. A minimum of 20 flashes per minute is recommended. Land aerodromes display white or white/green messages while water aerodromes display white or white/yellow messages. The flashes are to be visible in all directions. This material is based on ICAO standards.

Identification (code) beacons display green messages at land aerodromes and yellow at water aerodromes. Messages are to be visible in all directions and visible well above the horizon. Messages are international Morse code with six to eight words per minute (Morse code symbols are 0.15 to 0.2 seconds per character).

Low intensity obstruction messages are fixed and red in color in all instances; low intensity lights are to be at least 10cd. Medium intensity lights are red and flashing with 20-60 flashes per minute. Medium intensity lights when employed with high intensity lights are to be white.

High intensity lights are always white. Flashes are to be 40-60 per minute except for lights on power transmission towers where they are to be 60 flashes per minute. High intensity lights, other than for towers, are to flash simultaneously. Tower lights flash in a sequential pattern beginning with the middle light, continuing with the top light and ending with the bottom light.

Lights for unserviceable areas (within restricted use areas) can be a fixed red light or a flashing red of yellow light (ICAO 1990, 94).

CHAPTER THIRTY-SIX

PARTIALLY-LIGHTED & UNLIGHTED

AERONAUTICAL NAVIGATION AIDS

36A Signs & Markings

36A1 Introduction to Chapter 36

It was a relative easy task to divide up marine aids to navigation: lighted aids were assigned to one chapter, daybeacons to another. It was, of course, presupposed that lighted aids were not fully lighted and that an integral day dimension was present (a limited number of marine aids now display strobe lights and that somewhat alters the situation). The primary sources for this segment are ICAO publications: Annex 14, 1990, Volume I, Ch 5: 5.4 & 5.5, Chs 6 & 7; Volume II, Ch 5: 5.1 & 5.2, Ch 33).

The primary problem for marine aids was the point of differentiation between what are termed major lights and minor lights; all forms of buoys were considered separately. Aero navigation aids presents a more complex matter. Aero lighted aids lack a integral day aspect in most cases (obstruction marking can considered to be an exception) and some lighted aids are fully-lighted while others are a fully-lighted aid but only during periods of operation and thereby partially-lighted for the classification. As noted previously, partially-lighted for aero aids has a different meaning than it does for marine aids.

There is a second problem in dealing with aero aids that are not fully-lighted (that is, aids that are operational at all hours versus aids lacking a day dimension but are not operational at all hours): the problems of signs which may or may not be lighted. Some forms call for illumination, others may or may not be lighted, and yet others are never lighted. And the form of illumination can be an integral part of the message or it can be a substitute for natural light and thereby take on the form of floodlights. Even in cases where the lighting is internal and integral to the sign the place of light is different than the place of light in a lighted aid that lacks an alphanumeric or other symbols. Why? because the light dimension of a sign is not required for the sign to act as a sign at least some of the time. But a light aid does not exist in its message capacity except when the light dimension is activated (and a unit of light energy has no other dimension while a lighted sign includes not only light energy but also a symbol in some form).

There is seemingly no adequate response to the problem of differentiation of aero aids that may or may not contain or accompany some measure of illumination. The response of this study has been to: 1) assembly all lights with a substantial lighted dimension together and then 2) assembly essentially unlighted aids - including some with a more limited lighted dimension - in a separate grouping. All aero lights for this study are located in Chapter 35 and all unlighted and partially-lighted aids in this chapter.

This chapter begins with signs (36A2) and markings (36A3) and continues with indicators

(36B1), markers (36B2), obstruction markings (36B3), and restricted use markings (36B).

36A2 Signs: Types & Messages

Signs are comprised of two multi-member categories: mandatory instruction and information signs, and two single-member categories: aerodrome identification and aircraft stand identification signs.

Mandatory instruction signs consist of prohibitions on movement messages (except when authorization from the control tower is given). ICAO includes three forms of these signs: taxiway/runway intersection signs, category II/III holding signs, and no entry signs. From the accompanying descriptions of signs and messages it may seem that a non-category II/III holding position sign is also in use but that function is subsumed within taxiway/runway sign forms. Illumination can be provided if signs are needed at night; that illumination can be either internal or external. Both incandescent and fluorescent lamps can be employed as a lighting source for internal illumination (Safe Signs 1989, 34 and Curved Signs 1989, 39).

These signs are rectangular (which is the recommended shape of all ICAO sanctioned signs) with a red background and white message forms (termed inscriptions by ICAO). Taxiway/runway intersection signs include runway designations for one or both ends of the runway that intersects with a taxiway. No entry signs denote prohibitions that are definitive and that preclude exceptions. The remaining holding position signs are for Category II, Category III or joint Category II/III operations.

Information signs include two general forms, a catch-all form, and a specific form. General forms encompass needs for information on location or destination in regards to movement activities. Signs "provid[ing] other information" constitutes a catch-all category. The specific form contains the VOR aerodrome check-point sign (and marking).

Information signs have either a yellow background with black message forms or a black background with yellow message forms. These signs may be illuminated by internal or external means, or they may be enhanced with retro-reflective materials. The VOR check-point sign can have one of several message forms: one indicates that this is a VOR checkpoint, another indicates the VOR radio frequency, yet another denotes VOR bearing, and finally one giving the distance to a VOR collocated DME unit. Information signs for destinations include the appropriate alphanumeric or word abbreviation as well as an arrow indicating the destination.

Aerodrome identification signs are installed where visual identification of the aerodrome is inadequate. The message consists of the name of the aerodrome. No specific colors are given though the colors selected should offer contrast to the surrounding background of the sign. No mention of illumination is made by ICAO. Aircraft stand identification signs follow the color pattern for information signs. It can be illuminated externally or internally if necessary.

36A3 Markings: Types and Messages

Markings can be divided into two principal groups: runway-related functions and taxiway-related functions. ICAO considers the markings individually without any intervening distinction; nonetheless, they can be grouped according to function without altering ICAO's order. White is the color used for all markings. Visibility of markings can be increased by outlining them in black.

Runway designation markings are found at the threshold of paved runways. They are marked by a two-digit number. If there are parallel runways the number is supplemented by a letter. The number is determined by a set formula based on magnetic north. The letter is either L for left, R for right and C for center. Three runways would be marked by L, C, R and six runways would be marked by that pattern twice over.

Runway centerline markings are found on the centerline of the runway between designation markings. The centerline marking is composed of equally spaced stripes and gaps. Each unit (one stripe and one gap) is 50-75m in length. The centerline for Category II and Category III is .90m wide Category I and Code # 3, 4 (precision instrument operations) require .45m wide centerlines. Non-precision operations that are code #1 and #2 are to be .30m in width.

Threshold markings are found at the threshold of paved instrument runways and paved non-instrument runways that are code #3 and #4. They consist of longitudinal stripes grouped around the centerline. A 18m wide runway would have four stripes while a 60m wide runway would have 16. Runways of other widths would have the

appropriate number of stripes for those widths. The stripes are divided equally along the centerline. They measure 1.8m by 30m with a spacing of 1.8m. A transverse stripe is added for a threshold separated from the extreme end of a runway or where the runway centerline does not square with the centerline. An arrow is added for a displaced threshold.

A fixed distance marking is added for Code #4 runways. It begins 300m from the threshold and consists of two rectangles that are 45 to 60m in length and 6 to 10m in width. ICAO describes them as "conspicuous rectangular markings" but it is not clear what color the markings are. They appear to be at variance with the color of other markings.

Touchdown zone markings are added to precision approach runways. The markings are rectangular in shape and are arranged alongside the center line. The length of the runway determines the number of such markings. A runway of less than 900m would have a single pair which a runway at least 2100m in length would have six pairs. There are two patterns to follow: one pattern has single TDZ markings throughout while the other pattern begins with single stripes for the first two groups, double stripes for the next two and triple stripes for the last two. The first pattern has stripes that are at least 3m wide and 22.5m in length. The second pattern reduces the width to 1.8m.

Runway side stripe marking is installed between thresholds in those cases where there is little contrast between runway edges and adjoining terrain. The stripes are at least .9m

for runways at least 30m in width and a minimum of .45 m for narrower runways.

Taxiway centerline markings are a feature of air operations on a Code #3 or #4 level. They extend from runway centerline to aircraft stand markings. It is recommended that such markings be added to Code #1 and #2 operations as well. The line is to be a minimum of 15 cm in width and is a continuous line. The line is broken at intersections with taxi-holding lines.

Taxiway holding markings are installed adjacent to taxiway holding positions. There are two patterns. The first consists of four lines of which two are solid and two are segmented. The four lines together are 1.5m in width. Holding positions near runways employ that form. The second pattern consists of two parallel lines connected by cross bars. This pattern is 1.20m in width.

Taxiway intersection markings can be displayed where two taxiways intersect and a holding limit is in effect. It can also denote planes spacing safety limits. The marking consists of a segmented line across the taxiway.

VOR aerodrome check-point marking consists of a circle 6m in diameter with circle line 15cm in width. A directional arrow can be added that extends across the circle and extends beyond culminating in an arrowhead. This form of marking is used in conjunction with VOR check-point signs.

Aircraft stand markings denote parking positions. There are numerous elements that can be included with these markings: alignment bar,

identification of stand, lead-in line, lead-out line, stop bar, turn bar and turning line. Alphanumeric symbols can be added to the lead-in line. Character of lines and dimensions vary according to function. Apron safety lines delineate ground vehicle areas of operation. These lines are continuous in form and at least 10cm in width.

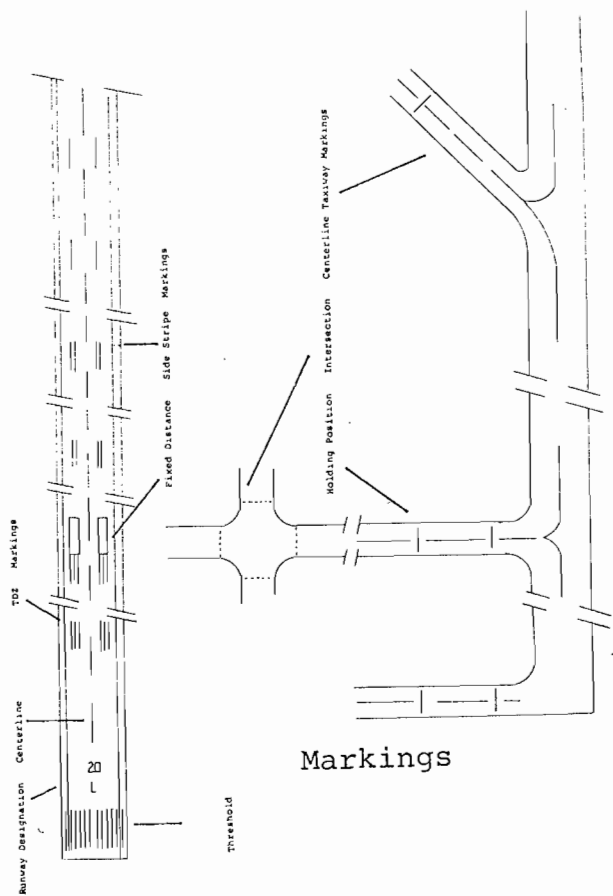

Markings

36B Indicators, Markers, Obstruction Markings & Restricted Use Markings

36B1 Indicators: Types & Messages

Indicator is yet another term that is not easy to define. In aero aids it includes aids that precisely define the direction a pilot should go, or other information of a precise nature. It applies to all lighted precision approach descent indicators as well as wind cones and wind tees. Frequently, references to wind cones and wind tees are directly to those aids without an overarching title; ICAO, however, provides such a title.

ICAO employs more formal language for the constituent elements of indicators; wind cones thereby become wind direction indicators. Wind indicators are sometimes termed wind socks (Thorn Europhane 1992; Danaid 1991, WC-18). ICAO 1990 describes the cone as a "truncated cone made of fabric." ICAO 1983 provides only limited information; however trade literature and FAA supplies ample details. The wind cone is mounted a pole that is either rigid with hinges or frangible. The cone is connected to a bearing assembly that allows even slight breezes to move the cone. Wind cones can be either lighted or unlighted. Illumination is provided by flood lights mounted at the top of the pole; an obstruction light may also be added.

The wind cone message is simple: wind moves the cone and thereby indicates direction of wind and, to some extent, the strength of the wind. ICAO recommends one color for the cone; either white or orange. If two colors are employed they should be selected from orange/white,

red/white, or black/white. Two-color patterns are arranged in alternating bands with the dark color at the ends of the cone. A white circle around the base of the wind cone is recommended. In the event of multiple wind cones at an airport there should be at least one that is lighted, and one that is equipped with a white circle.

Wind "Tees" are termed landing direction indicators by the ICAO. They are constructed of wood or metal. The tee is mounted on a reinforced concrete pedestal equipped with a bearing assembly for easy movement of the aid. ICAO states that the tee is to be white or orange though at least one maker, ADB, supplies tees in aviation yellow (ADB A.08.410e). Night-time use requires illumination of the tee which can be accomplished by outlining the tee or by other procedures. Tees that are outlined with lights may have as many as 32 light fixtures with half for each angle of the tee. ICAO recommends white lights though older tees approved by the FAA displayed green lights. Some forms of the tee contain a mechanism that limits the movement of the tee to predetermined directions. An older publication of Crouse-Hinds notes there are two functions for a wind tee: indication of wind direction or of recommended landing direction. Crouse-Hinds further notes that wind tees can be free floating (affected exclusively by the wind) or remotely controlled (indicating landing direction) (Crouse-Hinds 1962, 305-6A).

36B2 Markers: Types & Messages

The physical form and the message emitted by markers are so closely related as to be

virtually one. This is true, of course, for many sign and non-sign markings (see for example, Chapter 32F in Volume II, Part F, **International Railway Signals** in this series). This is in contrast to lighted aids whose physical apparatus and resulting messages can be viewed as two elements. Markers frequently display a significant vertical dimension in contrast to markings which are characterized by a horizontal dimension.

However, aero markers do not constitute a monolithic entity. For example, some forms display a substantially horizontal dimension. How then do markers and markings differ? Markings (this somewhat applies to traffic control devices though there are differences between aero and tcd forms) are usually in a paint medium and therefore lack a dimension that stands out from the surrounding surface. Markers, by contrast, do stand out and more often exhibit a vertical form than one that is horizontal. Obstruction markings are vertical rather than horizontal but they, like aero pavement markings, do not stand out from the surrounding surface.

It may be said that most categories of transportation markings have a core identity and the terminology and characteristics of those forms of markings flow from that core image. Other forms, while only partially conforming to that identity, remain part of that core image. An alternate view might suggest that some transportation markings lack an independent identity (or are too small to constitute a category in their own right) and are simply attached to some form that partially overlaps with it.

ICAO standards are more general in character than those of national standards (such as those of the U.S. FAA). Nonetheless some general comments can be made. There are two forms of unpaved runway edge markers: flat rectangles that are at least 1m by 3m, or conical shaped markers no more than 50 cm in height. Stopway edge markers should be quite different in shape so they are not confused with runway edge markers. ICAO speaks of "small vertical boards" for stopway edge markers. Snow-covered runway edge markers can consist of evergreen trees (which suggests a resonance of petit arbres in marine aids to navigation) or "light-weight markers". The later description is notably vague; shape and other characteristics are difficult to determine.

ICAO 1990 does not give actual shapes for taxiway edge markers but it is quite possible that they resemble those of runway edge markers. Taxiway centerline markers are low-level though, nonetheless, slightly raised above the surrounding surface. The comments of ICAO may suggest, or at least not rule out, retro-reflective markers similar to those employed for road centerline markers (ICAO 1983 notes that a retro-reflective character was the single point agreed upon as of that writing). Taxiway edge markers for unpaved taxiways can probably be of more than one shape; ICAO specifically mentions one shape: conical-shaped markers. ICAO 1983 notes that taxiway markers are usually cylindrical in shape; this may well be true of other forms as well (it is true of ADB). Cylindrical markers have a frangible pipe or post if the actual marker is rigid. Some markers "bounce back" if run over and do not require a frangible character.

Boundary markers, by contrast, are presented in some detail. They can have the shape of a low-level triangular-shaped object long in length and narrow in width. They can also exhibit a conical shape which suggests a form approved for runway and taxiway markers.

It has been noted that retroreflective markers are becoming more common. This may have been influenced by more readily available reflector materials. It has been influenced as well by the advent of MLS which allows for simpler lighting systems and greater use of reflective markers (Pollock 1990, 35, 37).

The matter of messages appears to be fragmentary and somewhat chaotic. ICAO 1990 specifies color for taxiway markers only. ICAO 1983 indicates color code discussions were so far incomplete. That same document indicates taxiway markers can be employed for unlighted taxiway situations while ICAO 1990 refers only to unpaved taxiways. The ADB catalogue (1991) states that an ICAO color code for both taxiways and runways is extant (ADB 1991 A.03.710e). That same catalogue presents the following color configurations: a yellow post or pipe for runway markers with a sheath or sleeve of white; taxiway markers are blue for post and sleeve while taxiway center line markers are green in color.

ICAO 1983 includes Swedish material on boundary markers that can presumably be applied to those markers in general. Sweden has developed a form of boundary marker to denote a slope below runway markers. The boundary marker units are arranged in a zig-zag pattern to denote the slope. The color pattern is made up

of black and yellow fields. ICAO 1990 suggest several color patterns: one color of orange or red; two contrasting colors, orange and white; or two alternative colors, red and white. ICAO 1983 black and yellow is not mentioned. The fields are alternating patterns of black and yellow with the colors of each side of the marker arranged in a contrasting pattern. Boundary markers are to be a maximum of 200m apart if in the triangular form and 90m apart if of the conical form.

ICAO 1990 speaks of merging day markers with lights. It is not clear how often that is done. Manufacturer trade literature seems to indicate they are separate aids. In some instances a lighted aid and a day aid are in close proximity though still separate and distinct. Of course a lighted aid with integral day dimension constitutes a partially-lighted entity and of a different nature; such aids are akin to marine aids to navigation more than commonly accepted versions of aero aids.

36B3 Obstruction Markings: Types & Messages

Obstruction markings are termed "Visual Aids for Denoting Obstacles" by ICAO but the shorter term will be generally employed in this study. Pavement markings are applied to a surface but the purpose of the marking is more than a simple denoting of the adjoining surface while obstruction markings are precisely that: a simple denoting of the surface to which they are attached.

Other non-sign markings are divided according to form so that markers are separate from markings. This does not hold true with

this area. The term obstruction markings serves as an overarching term for all non-lighted obstruction aids; spherical markers and flags as well as painted markings are encompassed by the general term. There are general rules for the use of obstruction aids and specific norms for the individual types of these aids. However, this study will focus on the obstruction aid and give less attention to more general considerations.

Patterns are the primary form of these markings. They can appear as solids, bands or checks. Bands can be either vertical or horizontal depending on the dimensions of the object to be marked. Checks are employed when an object displays a largely unbroken surface and the object is at least 4.5m both vertically and horizontally. Checks are to be 1.5-3m in both directions and the darker color is assigned to the corners of the object.

Alternating bands are employed if one dimension is more than 1.5m in one direction but less than 4.5m in the other direction. Bands are used on largely unbroken surfaces. The bands are perpendicular to the object's greatest dimension which means that the band can be either horizontal or vertical in a given situation. The width of the bands is 1/7 of the object's largest dimension as a general rule. ICAO supplies a table for determining width of band for various sizes of objects. Bands are proportionately narrower as the size of an object increases. Bands are also used on skeletal objects if at least one dimension is more than 1.5m. Solids are used when both horizontal and vertical dimensions are less than 1.5m. The principal obstruction marking colors

are orange and white; red and white are an acceptable alternative. Either orange or red is used when a single color is required.

Spherical markers are attached on the object in such a way that the general shape of the object is retained. Spherical markers are placed on problems areas such as overhead wires and cables. Spheres should be at least 60 cm in diameter. Individual markers are of a single color and the markers are placed in an alternating arrangement: white and orange or white and red.

Flag markers (ICAO refers simply to flags while FAA refers to flag markers; it seems more consistent to speak of spherical markers and flag markers than to speak of markers - which turn out to be spherical - and flags). Flag markers are situated on the top or uppermost edge of an object or around an object. They are positioned 15m apart and are to be at least .6 m square. Such markers can be solid orange or composed to two triangular swatches, one white and one orange. FAA permits checkerboard pattern as well but that form is not found in ICAO (FAA 1991 OML, 7).

36B4 Restricted Use Area Visual Aids

There are four aspects to "Visual Aids for Denoting Restricted Use Areas" to employ the ICAO term. They include closed runway and taxiway aids, non load-bearing surface aids, pre-threshold area aids and unserviceable area aids. Closed markings are located at or near the end of the closed area. They consist of a cross whose arms are .9m by 6m at a minimum and are white or yellow in color. The cross is

often termed a Saint Andrew's Cross though that term is absent from ICAO's coverage.

Non load-bearing surfaces markings denote areas that cannot take a plane's weight but that are indistinguishable from load-bearing taxiways, holding bays, aprons and other similar situations. They are marked by taxiway side stripe lines which is comprise of a double line at least 15cm in width with 15cm minimum spacing between lines. The color is that of taxiway centerline marking.

Pre-threshold markings are areas more than 60m in length that are not capable of regular aircraft usage. Such areas are marked by chevrons in a recommended color of yellow. The chevrons are at least 15m in length and 30m apart.

Unserviceable area aids are more complex. They can contain lighted forms which are considered with obstruction lighting. These areas are not suitable for aircraft but they are also areas that can be skirted by aircraft. They may include, for example, an area containing potholes or a construction zone. The markings are arranged so as to outline the area of concern. These aids take the form of markers except for those that are lighted. The markers can be flags, cones, or marker boards. Cones can be red, orange, yellow or a combination of white and any of those colors. Flags follow the same norms for colors as cones. Marker boards display vertical stripes that are red and white or orange.

CHAPTER THIRTY-SEVEN

ELECTRONIC AERO NAVIGATION AIDS

37A FULLY INTEGRATED SYSTEMS

37A1 Chapter 37: Overview & Changes

The taxing problem of terminology is addressed or at least broached elsewhere in this monograph. For this chapter electronic aero navigation aids or radio aids will suffice for terms though they do not eliminate the problems of terminology. One point of illumination for this problem is found in an AI article (Olsen 1992, 12) in which the author notes that an ILS is "not strictly a nav aid." Olsen in a 1990 article notes that in 1970 "navaids include. VOR/DMEs and NDBs (Olsen 1990, 37). Both statements confirms the suspicion of this writer that aviation experts count as navigation aids only those aids strictly and directly involved with navigation in a precise way. Yet that means not only lighted aids for aircraft moving on the ground but all aids - including radio aids - employed for approaching an airport seemingly fall outside of a strict sense of navigation aids. Though, to adopt a marine viewpoint, navigation aids can pertain to all aspects of the movement of a marine craft from dock to waterway and to dock and all aids are so regarded. In this chapter all electronic aids are navigation aids even though that may merit criticism in some quarters. The literature of aero navigation at times speaks of CNS: communication, navigation and surveillance

systems and this provides a larger context for viewing aero navigation aids (Olsen 1991, 12).

ICAO materials, of course, were vital for this treatment. Annex 10, **Aeronautical Telecommunications** was the primary resource. Articles from **AI** were also of notable value for the coverage.

Foundations (Part A, 2nd ed in this Series) offers reflections on electronic concepts including both theoretical and applied dimensions. The reader can consult that monograph for background and adjunct material on that topic. This chapter considers changes in navigation aids that are underway as well as the various navigation aids in their present state.

Navigation aids are considered in two groups: fully integrated systems (37A) which consists of ILS and the developing topic of MLS; and independent and partially integrated systems and multi-mode systems (37B). The later group includes beacons (both directional and non-directional), and multi-mode aids. By multi-mode are meant aids that are shared with the marine community: Loran, OMEGA and satellite navigation. Previously mentioned beacons may be stand-alone aids or aids in conjunctions with other aids. Multi-mode are included since they aero-related and thereby require examination. Loran and Omega are considered only briefly since they are reviewed in the marine monograph. Many of the traditional aids can be viewed as "point-source aids since the information that they emit is "relative to the point on the earth's surface at which the aid is located." This is in contrast

with many newer aids that are hyperbolic in nature (Olsen 1990, 37).

A review of ICAO and other publications, and perhaps this study as well, may suggest a stable and solid situation with aero aids. However, that stability and solidity are accompanied by uncertainties as well. Traditional aids, such as ILS, VOR/DME and especially NDB, may be in a transitional state while MLS and satellite systems may eventually eclipse and overwhelm the older aids. However, many of the older aids continue to hang on. In some cases older aids have undergone revitalizing with some increase in numbers. At least one expert, in viewing the ILS-MLS situation, has asked whether it is a matter of "when, if even, to phase out ILS rather than when to implement MLS." (Olsen 1990, 42).

Indications of the decline of conventional aids can be easily found. For example, Olsen (1990, 37-42) notes that in 1970 VOR/DME dominated world air routes, that NDBs were commonplace, and most industrialized states had aero aids equipment manufacturing concerns. But in 1990 the NDB is no longer approved by ICAO (though ICAO publications do not appear to state that is the case; Olsen 1991-1 does speak of a gradual withdrawing of NDBs), DME is replacing ILS Locators, and aircraft-based systems have reduced the value of VOR. The ILS and MLS controversy continues and ICAO is looking toward navigational satellites. IATA holds the view that VOR/DME are only needed in terminal areas; nonetheless, they continue to fulfill a larger role. In fact Russia is implementing a vast VOR system across the breadth of that nation (Olsen 1990, 42).

But signs of the continued importance of such aids are also available. Hyperbolic systems, such as Omega and Loran-C, have advantages over VOR though neither of those systems has an open-ended future. Loran-C was supposed to be phased out yet remains a popular aid. And VOR still has a dominant role; DME along with VOR will still be in use at least for the early part of the 21st century. NDBs, for example, remain vital in many areas including northern Canada. Eventually GNSS will become a significant alternate in Canada yet the usefulness of NDBs will continue for quite some time (Canada 1992 ANSP, 9-14).

ILS was scheduled to be eliminated by the year 2000 (at one point MLS was to be the officially sanctioned aid by 1995 then that was moved forward to 1998 (Buttersworth-Hayes 1986, 23-27; Glines 1989, 27). But many sceptics of MLS remain unconvinced and new ILS equipment is finding a market. Eventually MLS may yet become dominant. ICAO has had conferences on satellite navigation and other navigation and communication concerns under the acronym FANS or Future Air Navigation System. FANS topics include Global Navigation Satellite Systems or GNSS (which includes U.S. GPS and Russian GLONASS). References for FANS include MLS: Setting the Future Standards 1984, 31ff; Buttersworth-Hayes 1985, 36-37; Olsen 1991-1, 28; Olsen 1991-2, 12ff; and Fans 2 1990, 16.

37A2 Instrument Landing Systems (ILS)

The purpose of the ILS is to create an approach path for aircraft on the final approach to landing; it includes both azimuth and descent information. Components of such a system

include two directional transmitters (localizer and glide slope), and two or three marker beacons. A DME may serve as a replacement for the outer marker beacon and, according to one source, and DMEs are replacing localizers for ICAO. A locator (compass locator for the US) can replace outer marker or middle marker beacon. The ILS supplies guidance, range, and visual information. The last-named function is considered in Chapter 36. This treatment of ILS has been substantially guided by U.S. AIP (AIP 1991, 0-8 to 0-10); ICAO documents have also been consulted.

The Localizer unit provides lateral guidance for aircraft approaches. Specifically, it provides course guidance for the runway centerline. It broadcasts on a VHF frequency between 108.10 MHz and 111.95 MHz. The VHF signals are modulated with two navigation tones at 90Hz and 150Hz. The identification signal is in Morse code and consists of two or three letters preceded by the letter "I". The 90 Hz tone denotes the fly right indication while the 150 Hz denotes the fly left message. The antenna array is situated on the far end of the runway from the approach end and consists of short masts across the far end of the runway with shorter masts radiating out from the vertical masts. Other elements of the physical plant include an equipment hut, transmission equipment, monitoring and control equipment. An on-course position results in an equal tone from fly left and fly right indicators and the needle thereby denotes on-course status.

The glide slope provides angle of descent information and thereby denotes minimum decision height (DH). The glide slope broadcasts on a

UHF frequency between 329.15MHz and 335.00MHz. Modulation frequencies are 90Hz and 150Hz and also give guidance data. There is no identification signal. The glide slope is paired with the localizer thereby creating a single ILS aid. The physical aspect includes an equipment hut, transmitter, antenna, and monitoring and control equipment. There are several different antennas that can be used for a glide slope.

The receiving unit for the localizer and glide slope can display a double gauge. The localizer gauge displays a vertical needle which indicates whether the aircraft should go to the right, or to the left or whether the aircraft is on target. The glide slope gauge displays a horizontal needle that indicates whether the plane should fly up, fly down or is on course. The 150Hz signal denotes fly-up and the 90Hz signal denotes fly-down. The center point between signals indicates on course.

Marker Beacons denote points in the approach path for ILS. The beacons emit a vertical pattern that creates a horizontal elliptical pattern; the frequency is 75MHz. In many instances there are two marker beacons: an outer beacon and an inner beacon.

The Outer Marker Beacon is four to seven miles from the runway threshold. The modulation frequency is 400Hz. It marks the intercept point for the glide path procedure turn altitude. The message pattern displays two dashes in Morse code with a blue light for the reception end. A gauge with as many as three lights can display this and the other beacon messages.

The Inner Marker Beacon is 800-1500 feet from the threshold. The modulation frequency is 3000Hz. It denotes decision height (DH) of 100 feet above touchdown zone's highest elevation. The Morse code message consists of six dots and the light is white.

The Middle Marker Beacon, when in use, is 2000-6000 feet from the threshold. It denotes the decision high point. It gives an amber light and Morse code dot dash message pattern. In some instances a Back Course Marker Beacon is employed. It has a modulation frequency of 3000Hz and emits a dots pattern in white light.

Outer Marker Beacons consist of dipole antennas (which is a basic form of antenna and one that is the source of many other antenna forms; Turner defines it as a "center-fed signal with a half-wave length long that is suitably corrected for end effects." and mounted over a counterpoise (Turner 1991, 398). The equipment hut would be near or beneath the counterpoise. Compass locators share the same shelter. New versions display vertical array antennas with a solid-state transmitter.

Locators or Compass Locators (which is a NDB when used in ILS) serve as a supplement for Marker Beacons for the U.S. (AIM 1991, 1-1-6) (and as a replacement for such beacons in ICAO. They operate on a frequency between 200 and 415kHz. The message is in Morse code and has two letters. The outer locator transmits the "the first two letters of the localizer identification group" while the middle locator has the last two letters.

MLS gains its name from the frequency it employs: the 5 GHz microwave band. This frequency greatly reduces the problem of multipath (multipath transmissions consist of two or more paths with one part from the transmitter while another path reflects off objects (Turner 1991, 398). Multipath, to which ILS is prone, lowers the quality of signals and is common to mountain areas (and even less rugged terrain) and in diminished weather conditions (rain and snow). There are 200 channels that MLS can use instead of the 40 for ILS. The signal is of higher quality and gives a more rapid indication if an aircraft's approach path is inaccurate (MLS: Setting the Standards in **AI** 1984, August/September). MLS is generally seen as a landing system though it has also been seen as both a landing and departure system (Olsen 1990, 42).

MLS creates a cone shaped radiation pattern that is 40 degrees in width and 0 to 20 degrees for elevation. The azimuth function of MLS consists of a microwave beam that continuously travels over that degree range and the elevation portion does the same for that phase. Pulse measurement creates an exact determination of the aircraft's position. ILS equipment indicates if on or off and periodic indications of distance to threshold but it can not supply a continuous stream of data. MLS will not require straight courses as is the case with ILS.

MLS is able to meet the navigation needs of STOL and V/STOL in contrast to ILS. In part this is because angles of descent of more than 3 degrees are possible with MLS (Butterworth-Hayes 1985, 36 and 1986, 23).

A P-DME (Precision DME) with MLS supplies a continuous data flow as well. DME/P is a variant form known as Precision DME or DME/P with greater accuracy than the more familiar form. Other forms include DME/N and DME/W. DME/N uses enroute navigation with narrow spectrum; DME/W enroute with wide spectrum. ICAO recommends no further W after 1987 (ICAO 1987, 4, 27, 28).

The MLS azimuth station occupies a position similar to that of ILS localizer at the far end of the runway. The azimuth station scans the width of the runway twice per cycle; the first scan (the "TO" scan) begins the right side of the beam swath and continues to the left side of the swath. At a predetermined time it scans in the opposite direction (the "FRO" scan). The airborne unit picks up both signals, calculates the time readings and determines the aircraft's angle of approach.

The MLS elevation station occupies a similar position to ILS glide slope: about 1000 feet from runway threshold. The station performs a similar action but in a vertical direction: up then down. And again, the aircraft's receiver takes in the signals, calculates the readings and determines the elevation of the aircraft.

37B Independent & Partially Integrated Aids

37B1 VOR, TACAN, VORTAC & DME

ICAO is primary for all aspects of the study including this segment. But other resources have enhanced that core resource. Clausing's 1987 treatise entitled, **The Aviator's Guide to Modern Navigation** greatly aided the treatment (especially Ch 2, "VOR Navigation Fundamentals" and Ch 4, "VOR/DME Navigation"). Grover's 1957 work entitled, **Radio Aids to Navigation** also supported the treatment of 37B1.

Azimuth (directional) and distance (or position) information can be supplied by several forms of radio aids or combinations of such aids. The principal azimuth aid is the VHF Omnidirectional Range (usually referred to as VOR). The Distance Measuring Equipment (DME) is the comparable aid for position data. TACAN and VORTAC can also supply this information though they are not ICAO-sanctioned. Since they are approved by NATO and many nations active in aviation are members of NATO those aids are also included.

The VOR has been an important aid for more than 40 years. It took hold in the U.S. before becoming commonplace in other nations. It has been adopted by ICAO as the standard short range aid and eventually found global usage.

An older and once common aid, the MF four-course radio range, transmitted four narrow tracks while VOR in effect broadcasts 360 tracks since it is omni-directional. VOR transmits on a frequency between 108.0 and 117.95MHz with

modulated coded tone at 1020Hz for identification. The VOR transmits two signals. One is constant and denotes the VOR installation. The second indicates the position of the aircraft in relation to the VOR aid. The transmitting signals also include an identification message for the VOR unit. This is in Morse code. Many VORs have a voice transmission that can also identify the station as well as give other information.

The VOR can be viewed as a passive system since the unit continuously sends out signals without prompting by airborne navigational equipment. This contrasts with DME which is an active system.

The VOR indicates the radial that an airplane is on it does not indicate the actual position of the aircraft. The azimuth or directional data denotes relationship to a VOR but the plane could be anywhere on that radial from near the VOR to a considerable distance away. An additional aid is needed for position information. This unit is the DME or Distance Measuring Equipment facility.

DMEs are separate from VOR units but they can be seen "as essentially equal partners in an integrated system of navigation... ." (Clausing 1987, 38-48). Many VOR and DME units are colocated and thereby create a unified aid. DMEs are UHF rather than VHF and broadcast on frequencies between 962 and 1213 MHz with a modulated coded tone at 1350 Hz for identification (this is true for TACAN as well). Since the DME is an active unit it needs to be triggered before it will operate; the triggering mechanism is aboard the aircraft seeking to use

the DME. The DME is a form of transponder and when activated sends out pulses indicating position data. The two signals, one outbound, one inbound, constitute a cycle and the time that elapses in the transmission is translated into nautical miles or kilometers and thereby gives the aircraft's position. The onboard indicator displays a mileage meter and accompanying arrow indicator. DME has three versions: en route, landing and precision (Olsen 1990, 39).

The TACAN system was developed by the U.S. military to meet special military needs (such as the "rolling and pitching" of an aircraft carrier deck) (AIM 1991, 1-1-3). TACAN includes both azimuth and distance measuring capabilities. The DME function of TACAN is identical to that of the earlier described DME. However, DME for TACAN is an integral element rather than something "tacked on". Tacan broadcasts on UHF frequency in the 960-1215 MHz range. It is a pulse system. Airborne equipment translates the pulses into a visual form for both azimuth and distance information.

VOR and TACAN are separate units but since the airways served form a single system many VOR and TACAN units are located together. This results in VORTAC; it forms a single system with two elements: VOR and TACAN. Azimuth information is broadcast on both VOR and TACAN with DME on the TACAN portion only. The DME portion is the same whether a VOR/DME or VORTAC assemblage. A military aircraft can use the TACAN while the civilian pilot employs VOR and the DME part of TACAN. TACAN transmits on the same frequency as DME. The receiving unit

displays visual information for both azimuth and distance aspects.

VORTAC and TACAN are often employed by NATO nations; less often found in other states. For example, Norway, Denmark, France, Belgium employ VORTAC and TACAN while Switzerland, which is not a member of NATO, does not do so though surrounded by Vortac and TACAN users. Some non-NATO users do employ those systems; for example, Taiwan. (AIP and other materials from nations referred to provide the references).

ICAO includes VOR without mention of a form of VOR known as TVOR or Terminal VOR; U.S. FAA does include TVOR. A form of VOR known as DVOR refersto a variant form that utilizes the Doppler effect. DVORS present a purer signal since they are less affected by rough terrain and built-up areas. DMEs are also associated with ILS and MLS and will be alluded to in that context.

37B2 Beacons & Multi-Mode Radio Aids

This segment takes up both directional and nondirectional beacons; this approach corresponds to ICAO's category of Radio Beacons consisting of nondirectional beacons and marker beacons. Marker beacons are directional in form. Multi-mode aids (radio aids shared by aero and marine navigators) are considered in **Foundations** (Part A, 2nd ed). and **International Marine Aids to Navigation** (Parts C/D, 2nd ed). However, a brief review of selected multi-mode aids is included in this segment.

Nondirectional beacons, usually known by the acronym of NDB, is a LF or MF aid in the 190-535

kHz range (Clausing 1987, 78 TISRP). There are four types of NDB: the Compass Locator in ILS which is addressed there; the NDB approach aid in which the NDB is the primary approach system; the en-route NDB; and finally, high-powered NDBs from coastlines to offshore points. Marine radiobeacons are separate from aero forms though they too are NDBs. Clausing notes that any AM radio transmitter, even an AM broadcast station, could become a NDB as long as the transmitted signal goes in all directions. And the frequency range is just short of the AM range. NDBs remain a vital radio aid as indicated by AIP and other publications of many nations. It is especially important as both an approach aid and en route aid over large territories such as that of Canada.

The message consists of two parts: a continuous tone in the aforementioned frequency which is amplitude modulated by an identification signal in Morse code in either 400Hz or 1020Hz frequency; voice modulations are also sometimes present (FAA 1986-7, 47; also AIP 1991, 0-6; Clausing 1987, 87 for remainder of paragraph). The Morse code signal usually consists of three letters in the U.S. and either two or three letters elsewhere; Compass Locators have two letter indications. The reception end of the process requires an automatic direction finder (ADF). The ADF includes a receiver, two antennas (sense, and loop forms) and an indicator. The message is received on a gauge termed a compass card which displays bearing numbers and an arrow. A second unit contains a sound or aural unit for receiving the identification signal from the NDB and a mechanism for selection of the correct frequency.

Marker beacons are a major component of ILS and are discussed in that context (AIP 1991, 0-9). Marker beacons employed for en route purposes are included here. They are a VHF aid and transmit on a frequency of 75 MHz. There are three forms of the aid: Fan Markers, Low Powered Fan Markers and Z Markers. These markers are familiar to users of the older four course radio range aid. Fan or cone markers denoted radio ranges while Z markers denote a point between radio range stations. ICAO specifically mentions the use of markers for radio ranges though that appears to be an obsolete aid.

Identification of the aid, when required, is through Morse code. The message is frequently "R" (.-.) though other letters can be employed. The message can be a simple one of light and sound (hum) received in an airborne unit (AIM 1991, 1-1-5).

Grover in his 1957 (30-33 TISRPS) work notes that ICAO in 1954 recommended Consul as an "interim aid" until more modern aids were available. This applied to Loran as well. And in the latest (1985) edition of Annex 10 Consul is still included along with Loran-A which is an older version. Consul stations are found at several points in western Europe.

Consul, a descendent of the German Sonne, is a MF aid in the 255-415kHz range. It has proven to be an accurate aid with a considerable distance of 1500km. The transmitter unit is a single unit but with three antennas the signals gives the appearance of rotation. It is an omni-directional aid displaying a dot dash or dash dot Morse code signal. The complete cycle

consists of the basic message then a long dash followed by station identification and another long dash. IHB 1965 supplies information on Consul and Sonne as well.

Loran-A is a MF aid in a frequency range of 2MHz and follows a time measurement pattern with pulses emitted from a master and two slave stations. Aircraft equipment consists of a cathode ray oscilloscope that records the time from the incoming signals. The time differences can be employed to establish lines of position of the aircraft (Grover 1957, 63-64; see also IHB 1965). ICAO includes Loran-A rather than Loran-C yet the former is obsolete or nearly so and the later is still in use. Some relatively recent sources have viewed Loran-C as increasingly important for general navigation yet signs of its demise are also in evidence (Underwood 1987, 34ff).

Satellite navigation is not fully operational though it will in all likelihood become a vital element. Two systems well along in development are the U.S. GPS (Global Positioning System) and the Russian GLOSSNASS. A 1991 agreement called for a GPS and GLOSSNASS network that would constitute Global Navigation Satellite System (GNSS). GPS operates on two UHF frequencies: 1575.42MHz and 1227.60MHz. It has two levels of accuracy: military and civilian. The former is accurate to within 16 meters while the later is accurate within 100 meters. There are few limitations on the system. It is accurate at any time of day, or season or weather conditions. Neither do solar disturbances materially affect it. Satellites are very costly but receiver units are comparable to VOR/DME equipment. The complete

GPS operation will have 21 satellites. References for this material include Canada ANSP 1992, 9-15; Blacklock 1991, 13; see also Olsen 1990, 37-42; Clausing 1987, 169-179; and DOT/DOD 1992, 3-38 to 3.44; GNSS and Future Air Navigation System (FANS) resources include Olsen 1991, 12f, FANS 2 ... 1990, 16).

Haken Lans (GP&S Systems, Stockholm) sees satellite navigation as replacing "all existing navigation techniques." This results in a new global standard for navigation. GP&S Systems has the goal of "integrating GPS fixes with different types of guidance and information systems." The new way can include enroute, precision approaches and even taxiway movements (Blacklock 1991, 13). Satellite navigation and MLS have been seen as forming a system meeting future navigation needs (Olsen 1990, 38).

GPS is a time measurement system. Time elapsed from satellite to receiver is multiplied by speed of light to gain a line of position. Three measurements result in latitude, longitude and altitude measurements. GPS is a passive system that continuously sends out data and does not need to be triggered. The receiver/computer takes in data from three satellites and computes the precise location of the aircraft. Because of the possibility of ionospheric disturbances signals are received on both frequencies. This allows for determination of any alterations due to the disturbances and for the correction of the flawed data. The process of receiving and calculating data is complex and requires the computer operation. The receiving assemblage consists of antenna, receiver/processor, and control-display unit.

Differential GPS has been developed for precision local navigation needs. In this system data is received from five or more satellites. Differences in the received data produce accurate fixes in the immediate area of the plane (Hobbs 1990, 587). Wilcox, to cite one example, has produced a Differential GPS (DGPS) with data receiving equipment units at airports. Accuracy of data is one to two meters (Wilcox 1993). DGPS augments satellite transmissions with corrections in data for aircraft (Blacklock 1991, 13).

* * * * *

The "Attachments" (a form of appendix) of the various editions of Annex 10, **Aeronautical Telecommunications** include references to aids little mentioned in contemporary publications on electronics and navigation. These aids seem to occupy a borderland between history and current practice. They are included here if only briefly.

Long distance aids in this category include Delrac, Dectra, Navaglobe and Navarho. Both "D" aids are part of the Decca company system, a British concern. Dectra focusses on a single route (in contrast to a system such as Consul). It is a directional aid of great accuracy and is designed for long distance navigation such as the North Atlantic. It is based on the techniques found with Decca. The system is termed a "track guide system" with two pairs (chains) of stations: two masters and two slaves. The transmissions form hyperbolic patterns and the messages are received by a two

airborne meters. One meter denotes relation of plane to track (whether to left or right) and the second indicates distance flown. Grover 1957, 114-117 was the principal reference to this coverage. IHB 1965 II. 3-2-29 to -31 provides coverage on Dectra as well as extensive coverage of Decca. ICAO publications discuss it very briefly.

Delrac (Decca Long Range Area Coverage) provides area coverage rather than track coverage. Delrac is a LF system and is highly accurate. It too is hyperbolic. The line of position provides a fix indicating the plane's position. It is a phase comparison as is Dectra. The processes are also similar to Decca (Glover 1957, 117-118).

The Navarho and Navaglobe systems are of American provenance. Navaglobe was an area coverage approach while Navarho was of directional form. ICAO, according to Grover, expressed a preference for Navarho over Navaglobe. However, ICAO presents the two as a hyphenated single system. All four systems appear in ICAO in the 1960s but have not been included for quite sometime.

Navaglobe measured distances through two transmitters while Navarho provided bearing and distance data from three transmitters. The three transmitter system are arranged in the form of a triangle. The station transmits one pulsed message for each pair of transmitters (the three transmitters are paired in turn providing three pairs and hence, three messages) then all three stations transmit together. The combined message is synchronized and broadcast on two frequencies. The aircraft's equipment

receives the three transmissions and by a comparison of them gains bearing information. The reception of the fourth signal allows a comparison of the two frequencies phase differences with that of a airborne oscillator unit which results in distance information. It would have required fifty stations globally to create full coverage for Navarho (Grover 1957, 118-119).

ICAO includes mention of two short range aids as well. These are GEE and VHF Multi-track pulse range. GEE can also serve as a medium range aid hyperbolic in nature with considerable accuracy. It consists of a master station and two or three slave stations. GEE creates lines of position as do other hyperbolic units but unlike some systems it can create multiple lines of position at one time (Grover 1957, 55ff). VHF multi-track system contrasts with VOR or VHF omni range system; information on the multi-track system is very limited.

APPENDIX

COMPARATIVE SURVEY OF ICAO-SANCTIONED AERO AIDS, 1949-1990

i General Considerations

This monograph has been heavily influenced by ICAO and its publications. So far in the study it has not been possible or appropriate to review the publications of ICAO with their structure and treatment of aeronautical navigation aids. This appendix will offer such a review.

ICAO treatment of Visual Aids has taken two forms: the first from 1951 (first edition) to and including 1971 (6th edition), and the second from 1976 (seventh edition) to 1990 (first edition of a split coverage: Volume I, aerodromes and Volume II, heliports). There is a significant alteration between the first editions and the more recent ones. Though it can be noted that the many differences over four decades does not fully eclipse many points of commonality.

The first three editions evince a complex structure: general items, aerodromes with runways, aerodromes without runways (with both lighted and unlighted aids in each category), and water aerodromes. The next three follow that pattern but eliminate water aerodromes. The three more recent editions are greatly simplified with all non-obstructions aids in a single chapter under the heading of "Visual Aids for Navigation". Obstruction aids and aids for restricted areas occupy separate chapters.

Radio Aids, while occupying more editions, follows a similar pattern over the decades though some increase in types of aids has occurred. Radio aids represent far fewer varieties; hence a greater commonality. The original edition, that of 1949, is not numbered. And the first edition, 1950, omits the words first edition from the publication. The other editions have these dates: 2nd ed, 1951; 3rd ed, 1952; 4th ed; 5th ed, 1958; 6th ed, 1960; 7th ed, 1963. 1st ed of split edition (Vol I), 1965; 2nd ed, 1968; 3rd ed, 1972; 4th ed, 1985.

The Attachments in Radio Aids mention other aids and these aids have been included at the conclusion of the review of Radio Aids. They may be more of historical interest than current systems.

ii Visual Aids: Lights

a) Visual Approach Slope Indicators

1st ed, 1951 & 2nd ed, 1953, None
3rd ed, 1958 & 4th ed, 1964, VASIS
5th ed, 1969, Above & AVASIS
6th ed, 1971 and 7th ed, 1976, Above
& 3-BAR VASIS, 3-BAR AVASIS, T-VASIS,
AT-VASIS
8th ed, 1983 & 1st ed, Vol I, 1990,
Above & PAPI & APAPI
1st ed, Vol II, 1990, PAPI, APAPI, HAPI

b) Approach Light Systems

1st ed, Approach Lighting System
Type "A", and Angle-of-Approach Lights
2nd ed, Approach Lighting System for
Runways with Neither Stopways nor

Displaced Threshold, Lead-in Lighting
System for Runways with Neither Stop-
ways nor Displaced Thresholds,
Approach & Lead-in Lighting Systems
for Runways with Stopways, Approach
& Lead-in Lighting Systems for Runways
with Displaced Thresholds, Angle-of-
Approach Lights
3rd ed, Precision Approach Runways
4th ed, Above & Simple Approach Light
System,
5th ed & 6th ed, Simple Approach Light
System & Precision Approach, Category I,
and Category II
7th ed, 8th ed, and 1st ed, Vol I, Simple
Approach Light System, Precision Category
I, and Precision Category II & III
1st ed, Vol II, Heliport Approach Lighting
System

c) Runway & Taxiway Lights

1st ed, Runway Lights, Runway
Threshold Lights, Taxiway Lights
2nd ed, Above & Stopway Lights
3rd ed, Above & TDZ Lights, Fixed
Distance Lights, Taxiway Guidance
System & One other item-Check
4th ed, Above & Runway Centerline
Lights, Runway Edge Lights, Taxiway
Centerline L., & Taxiway Edge L.
5th ed, Above & Runway End L, Exit
Taxiway Centerline L. on High Speed
Exit Taxiway
6th ed, Above & Exit Taxiway Centerline
L. on Other Exits
7th ed, Above & Runway Threshold & Wing
Bar L., & Clearance Bars
8th ed, Above & Taxi Holding-Position L.,

VDGS and ASMGL

1st ed, Vol I, Taxiway Guidance System
no longer present

d) Boundary & Range Lights

1st to 6th editions inclusive; originally
found with Water Aerodromes & Land Aero-
dromes without Runways
7th, 8th, and 1st ed, Vol I, II, no longer
listed

e) Beacons

All editions, Aerodrome Beacons and
Identification Beacons

f) Obstruction Lights

1st to 6th editions, Obstruction Lights, and
Hazard Beacons
7th ed to present, Obstruction Lights
divided into Low, Medium and High
Intensities

iii Visual Aids:

Indicators, Markers, Markings & Signs

a) Indicators

Wind Direction Indicators, All editions
Landing Direction Indicators, All editions

b) Approach Day Marking System

1st to 3rd editions, beyond that?

c) Runway Markings

Boundary Day Markings, 3rd-6th eds

Day Marking - Landing Aids,

Day Marking Aids, 2nd ed

Day Marking of Snow-covered Runways,
2nd ed

Displaced Threshold Markings, 4th-6th eds

(The word Runway added in 2nd ed;

Temporarily added before Displaced in
3rd edition)

Distance-to-go-Markings, 4th-6th eds

Fixed Distance Markings, 3rd-8th eds,

Land Aerodromes w/o Runways Day Marking,
1st ed, 3rd ed,

Paved Runway Day Markings, 2nd ed

Paved Runway Markings, 3rd-6th editions

Runway Caution Zone Markings, 1st ed

Runway Centre Line Markings, all editions

Runway Designation Markings, all editions

Runway Edge Markings, 1st-6th eds

Runway Longitudinal Markings, 1st ed

Runway Side Stripe Markings, 2nd onward

(The word runway added in 6th ed)

Runway Threshold Markings, all editions

(The word Runway dropped with 4th ed)

Stopway Day Markings, 2nd, 3rd, 5th eds

Touchdown Zone Markings, 3rd-8th eds,

Unpaved Runway Edge Markings, 4th ed

Unpaved Runway Markings, 2nd-6th eds

(The word Day added before Runway, 2nd
ed)

VOR Aerodrome Check-Point Markings, 6th-
8th eds

Water Aerodromes Day Marking, 1st, 3rd eds

(Ends with Landing Aids in 3rd ed)

d) Taxiway Markings

Aircraft Stand Markings, 8th, 1st-Vol I,

Apron Safety Lines, 8th, 1st-Vol I
Category II Holding Position Markings,
6th ed
Category II or III Holding Position Marking
7th (Within Taxi HP in 8th, 1st, Vol I
eds)
Day Marking - Taxying Aids, 2nd ed
Paved Taxiway Markings, 1st-6th ed
(Day after Taxiway in 2nd ed)
Taxi-Holding Position Markings, 3rd-
1st, Vol I eds
Taxiway Center Line Markings, 5th-1st,
Vol I, eds
Taxiway Day Markings, 1st ed only
Taxiway Guidance System, 4th-6th eds
(Stop Bars, Clearance Bars under TGS
in 6th ed)
Taxiway Intersection Markings, 8th,
1st-vol I,
Taxiway Longitudinal Markings,
Taxiway Side Stripes Markings, 6th-1st,
Vol I eds
Water Aerodromes Aids to Taxying, 1st ed
Unpaved Taxiway Markings, 2th-6th eds
(The word Day precedes Markings in 2nd)

e) Obstruction Markings

Colors, All editions
Flags, All editions
Markers, All editions
Visual Aids for Denoting Restricted Use
Areas, 7th - 1st VI
Closed Markings, 6th-1st, Vol I eds
Chevron Markings, (or Pre-Threshold
Markings), 7th-1st ed, Vol I eds

f) Signs

Aerodrome Identification Signs, All
Editions
Aircraft Stand Identification Sign, 8th-
1st, Vol I ed
Category II Holding Position Sign, 6th ed
Category II or III " " " ", 7th ed
Information Signs, 8th-1st, Vol I eds
Mandatory Instruction Signs, 8th-1st,
Vol I, eds
Signing Aids, 6th ed
VOR Aerodrome Check-Point Sign, 5th-6th
ed

g) Signalling Devices

Ground Signal Panels & Signal Area, All
Editions

h) Markers

Boundary Day Markers, 2nd ed
Boundary Markers, 7th-1st Vol I, eds
Day Markers for Snow-Covered Runways,
3rd-6th eds
Day Marking, 2nd ed (Marker form)
Edge Markers for Snow-Covered Runways,
7th-1st Vol I, eds
Stopway Day Markers, 4th-6th eds
Stopway Edge Markers, 7th-1st Vol I, eds
Systems of Approach Day Markers, 3rd ed
Taxiway Edge Markers, 8th-1st ed, Vol I
Unpaved Runway Edge Markers, 7th-1st ed,
Vol I
Unpaved Taxi Edge Markers, 7th ed
Unserviceability Markers, 6th-1st, Vol I,
eds (Cones, Flags, Markers)
VOR Aerodrome Check-Point Markers, 5th ed

i) Approach Day Marking System

1st, 2nd & 3rd editions
(Takes form of markers rather than
markings;
title includes Markers not Markings for
3rd ed)

iv Radio Aids

a) Aids to Final Approach & Landing

Instrument Landing Systems (ILS),
All Editions
Localizer
Glide Path
Marker Beacons

"Pre-edition", 1949 to 6th ed, 1960 eds
Locator

Microwave Landing System (MLS), 4th ed,
Vol I, 1985

b) Short Distance Aids

VOR, All Editions
DME, All Editions
(4th ed, Vol I, has DME/N, DME/W, DME/P)

c) Radio Beacons

NDB, 2nd to 4th, Vol I eds,
En route Marker Beacons, 2nd-4th, Vol I eds

d) Long Distance Aids

Loran, 1st-1st, Vol, I eds
Loran-A, 2nd Vol I-4th, Vol eds
Consul, 5th edition to present

e) Other Aids (Listed in Attachment A)

Short Range Aids (2nd ed to present):

VHF Multi-Track Range
GEE System

Long Range (6th ed to at least 1st, Vol I
ed):

Dectra
Delrac
Navaglobe-Navarho

BIBLIOGRAPHY

i Books

- Ashford, Norm & Wright, Paul H. 1979. 1984 & 1992 eds. **Airport Engineering**. New York: John Wiley.
- Barthes, Roland. 1988. **The Semiotic Challenge**. New York: Hill & Wang.
- Belove, Charles. 1986. **Handbook of Modern Electrical & Electronic Engineering**. New York: John Wiley & Sons.
- Black, Archibald. 1929. **Civil Airports & Airways**. New York: Simmons-Board Publishing Co.
- Brooks, D. 1983. Navigation Lighting. In **Lamps & Lighting: A Manual of Lamps & Lighting Prepared by Members of the Staff of Thorn EMI Lighting, Ltd.** ed. by M.A. Cayless & A.M. Marsden. London: Edmund Arnold.
- Buck, J.H. & Pierce, J.A. 1947. Nonradar Navigational Methods. In **Radar Aids to Navigation** ed. by John S. Hall. New York: McGraw-Hill Book Company.
- Burden, William A.M. 1943. **The Struggle for Airways in Latin America**. New York: Council on Foreign Relations.
- Caldwell, Frank C. 1930. **Modern Lighting**. New York: MacMillan.
- Canner, W.H.P. 1986. **The Air Transport Industry**. Glasgow: Brown, Son, Ferguson, Ltd.
- Cannes, Keith. 1992. **The Loran, GPS & Nav/Com Guide**. Templeton (CA): Butterfield Press.
- Clausing, Donald J. 1987. **The Aviator's Guide to Modern Navigation**. Blue Ridge Summit (PA): Tab Books.

Clearman, Brian. 1992. **A First Study in Transportation Markings: The U.S.** Vol I, Part B, 2nd ed. Transportation Markings: A Study in Communication Monograph Series. St. Benedict (OR): Mount Angel Abbey.

_____. 1990. **Foundations.** Vol I, Part A, 2nd ed. St. Benedict (OR): Mount Angel Abbey. TMASIC Monograph Series.

_____. 1988. **International Marine Aids to Navigation.** Vol I, Parts C/D, 2nd ed. St. Benedict (OR): Mount Angel Abbey. TMASIC Monograph Series.

_____. 1990. **International Railway Signals.** Vol II, Part F. St. Benedict (OR): Mount Angel Abbey. TMASIC Monograph Series.

_____. 1984. **International Traffic Control Devices.** Vol II, Part E. St. Benedict (OR): Mount Angel Abbey. TMASIC Monograph Series.

Davies, R.E.G. 1972. **Airlines of the U.S. Since 1914.** London: Putnam.

_____. 1987. **Rebels & Reformers of the Airways.** Washington, D.C.: Smithsonian Institution Press.

Douglas, C.A. 1971. A Survey of the Use of Flashing Lights in Aviation. In **The Perception & Application of Flashing Lights** (An International Symposium Held at Imperial College, London Under the Joint Auspices of the National Illumination Commission of Gt.B. & The Applied Optics Section-Imperial College, Nov 19-22, 1971). Toronto: University Press of Toronto.

Douglas-Young, John. 1987. **Illustrated Encyclopedic Dictionary of Electronics.** Englewood Cliffs (NJ): Prentice-Hall.

Duke, Donald. 1927. **Airports & Airways: Construction, Operations & Maintenance.**

New York: Ronald Press Co.

Europa Year Book. 1986. 2 vols. London: Europa Publications, Ltd.

European Marketing Data & Statistics. 1993. 28th ed. London: Euromonitor.

Field, Arnold. 1985. **International Air Traffic Control.** New York: Pergamon Press.

Finch, Robert. 1938. **The World's Airways.** London: University of London Press.

Fink, Donald, ed-in-ch. 1982. **Electronics Engineer's Handbook.** 2nd ed. New York: McGraw-Hill Book Co.

Gibbs-Smith, Charles H. 1985. **Aviation: An Historical Survey from its Origins to the end of World War II.** London: HMSO.

Glidden, Horace K., et.al. 1946. **Airports: Design, Construction & Maintenance.** New York: McGraw-Hill Book Co.

Goldstrom, John. 1930. **A Narrative History of Aviation.** New York: Macmillan.

Greif, Martin. 1979. **The Airport Book: From Landing Field to Modern Terminal.** New York: Mayflower Books.

Grover, J.H.H. 1957. **Radio Aids to Air Navigation.** New York: Philosophical Library.

Harper, Harry. 1938. **The Romance of a Modern Airway.** London: Sampson Low, Marston & Co., Ltd.

Hobbs, Richard R. 1990. **Marine Navigation: Piloting & Celestial & Electronic Navigation.** 3rd ed. Annapolis, MD: Naval Institute Press.

Horonjeff, Robert. 1962. **Planning & Design of Airports.** New York: McGraw-Hill.

IES Lighting Handbook: The Standard Lighting Guide. 1947, 1952. 1st, 2nd eds. New York: Illuminating Engineering Society.

IES Lighting Handbook. 1966, 1972. John

Kaufmann, ed. New York: IES.
IES Lighting Handbook (Reference Vol). 1981.
John Kaufmann, ed. New York: IES.
IES Lighting Handbook (Reference Vol). 1984.
John Kaufmann, ed. New York: IES.
IES Lighting Handbook (Application Vol). 1987.
John Kaufmann, ed. New York: IES.
International Marketing Data & Statistics.
1993. 17th ed. London: Euromonitor.
Jane's Airport & ATC Equipment. 1990/1991.
David F. Rider, ed. Coulsdon, UK: Jane's
Air Transport Data.
Kayton, Myron, ed. 1990. **Navigation: Land,
Sea, Air & Space.** New York: IEEE Press.
Laughton, M.A. & Say, M.G., ed. 1985.
Electrical Engineer's Reference Book.
14th ed. London: Butterworth.
Leary, William M. 1985. **Aerial Pioneers: The
U.S. Air Mail Service, 1918-1927.**
Washington, D.C.: Smithsonian Institution
Press.
Lindsey, Jack. 1991. **Applied Illumination
Engineering.** Lilburn, (GA): The Fairmont
Press.
New Book of World Rankings. 1991. 3rd ed.
George T. Kurian, ed. New York: Facts on
File.
O'Dea, William T. 1958. **The Social History of
Lighting.** London: Routledge & Kegan Paul.
Parnell, Nevelle & Boughton, Trevor. 1988.
**Flypast: A Record of Aviation in
Australia.** Canberra: AGPS Publications.
Pirath, Carl. ed. 1938. **Aerodromes.** London:
Pitman.
Robinson, E.A. 1985. Radio Navigation Aids. In
Reference Dictionary for Engineers edited
by E.C. Jordan. Indianapolis: H.S. Sam & Co.
Saint-Exupery, Antoine de. 1942. **Night Mail.**
New York: New American Library.

_____. 1933. **Southern
Mail.** New York: Harrison Smith &
Robert Haas.
Saint John Sprigg, C. 1934. **British Airways.**
London: Thomas Nelson & Sons, Ltd.
Sessions, G.M., et. al. 1970. **Traffic
Devices: Historical Aspects Thereof.**
Washington, D.C.: Institute of Traffic
Engineers.
Sharp, H. Oakley, et.al. 1944. **Airport
Engineering.** New York: John Wiley & Sons.
Smith, Henry Ladd. 1950. **Airways Abroad: The
Story of American World Air Routes.**
Madison (WI): University of Wisconsin Press.
Smith, Philip. 1986. **It Seems Like Only
Yesterday: Air Canada, The First Fifty
Years.** Willowdale (ONT): McClelland &
Stewart.
Solberg, Carol. 1979. **Conquest of the Skies: A
History of Commercial Aviation in America.**
Boston: Little, Brown.
Taneja, Nawal K. 1981. **Airlines in Transition.**
Lexington (MA): Lexington Books.
_____. 1987. **Introduction to Civil
Aviation.** Lexington (MA): Lexington Books.
Taylor, Poyntz, ed. 1958. **Airways of America.**
New York: H.W. Wilson.
Turner, Rufus P. & Gibilisco, S. 1991. 5th ed.
The Illustrated Dictionary of Electronics.
Blue Ridge Summit, (PA): Tab Books.
Warner, Edward P. 1938. **The Early History of
Aviation.** Lecture at Norwich University.
November 21, 1937.
Whitnah, Donald R. 1966. **Safer Skyways:
Federal Control of Aviation, 1926-66.**
Ames (IO): Iowa State University Press.
Wood, John W. 1940. **Airports: Some Elements of
Design & Future Development.** New York:
Coward-McCann, Publishers.

The World in Figures. 1988. Boston: G.K. Hall.

ii Journals

The Aerial Lighthouse. 1923. **SA** (June): 400.
Aids to Better Lighting of Airports. 1929. **AC** (August): 127.
Air Markers. 1923. **Literary Digest** (March): 3.
Air Markers: Women Pilots Help Make Private Flying Safe. 1936. **Newsweek** (Aug 22): 25.
Air Markers. 1936. **Time** (Aug 24): 48.
Airmarking for Cities. 1927. **AC** (Sept): 309.
Air Marking Program. 1948. **AC** (June): 17.
Airport Lighting Systems Enables Landings on Bad Days. 1939. **SNL** (June 17): 375.
Airport Lighting to be Studied in 800-foot Fog Chamber. 1962. **Quarterly Bulletin of the Institute of Transportation & Traffic Engineering** (April).
Airports Receive New Taxi Light. 1956. **AW** (Dec 17): 40.
Airway Beacons with Double Beam. 1932. **SA** (Dec): 373-374.
ALPA-Recommended Approach Light System. 1949. **AW** (March 7): 40.
Approach Light Systems Analyzed. 1950. **AW** (May 8): 46-47.
Batchelor, James. W. 1947. Segmented Markers. **AW** (Oct 27): 15.
Blacklock, Mark. 1991. GPS The One Stop Answer. **AI** (April): 13.
Boone, Andrew R. 1932. Night Flying with Safety. **SA** (Aug): 71-73.
Brightest Lights Against Thickest Fog. 1949. **AC** (July): 127.
Butterworth-Hayes, Philip. 1986. MLS Campaign

Gathers Pace. **AI** (March) 23-24.
_____. 1985. New Wave in Troubled Waters. **AI** (March): 36-37.
_____. 1991. Old Hands Steer New Transition. **AI** (Jan/Feb): 14-17. (Under introduction of AACI: The New Era Begins).
CAA Pushes Approach Light Plan. 1950. **AW** (June 19): 47-49.
CAA Tests Systems of Approach Lights for Airports. 1945. **AC** (July): 113.
CAA Will Test New Runway Surface Lights. 1956. **AW** (Nov 26): 34.
CAA Withdraws Slope Line Support. 1950. **AW** (Jan 23): 15-16.
Centerline Lights Get Big ICAO Vote. 1952. **AW** (Dec 1): 14.
Centerline Runway Lighting is Approved. 1951. **AW** (Oct 29): 65-66.
Center-Line Test. 1950. **AW** (July 24): 50-51.
Clark, B.A.J. & Antonenko, P. 1993. A History of Visual Approach Guidance Indicator Systems in Australia. **Journal of Navigation** (Vol. 46 #1): 49-62.
Clear Reliable Guidance is Key to Taxiway Safety. 1989. **AI** (Jan/Feb): 16.
Çondom, Pierre. 1985. MLS: The Slow Stampede. **Interavia** (August): 879-881.
Cook, Robert H. 1960. FAA Evaluating Variety of Landing Aids. **AW** (March 28): 108-110.
Curved Sign Runs on Half Power. 1989. **AI** (Jan/Feb): 39.
Doty, L.L. 1957. Popularity of Centerline System Established in Air Force Tests. **AW** (11-19): 19.
FANS 2 Will Take Technology Closer to Implementation. 1990. **AI** (Jan/Feb): 16.
Ferguson, Erick. 1992. Up, Up, & Away: Are

Vertiports the Wave of the Future?
Planning (Feb): 10-13.
Flasher Lights for Airports. 1934. **SA** (July):
38.
Four Honored for Safety Work. 1951. **AW** (Nov
19): 19.
Gilbert, Gordon. 1985. Visual Approach Aids:
Is Standardization Good for Everyone?
Airport Services Management (June):
22-24.
Glines, C.V. 1989. MLS Takes a New Turn. **Air
Line Pilot** (July): 27-31.
Harvey, Emil K. 1941. Twenty-five Years of
Airports. **Aviation** (Aug): 84-85, 168.
Idaho Airmarking. **AW** (April 26): 34.
Keller, John. 1992. Smart System Sets a Shining
Example. **Jane's Airport Review** (March):
31-33.
Kendall, Brian. 1990. Air Navigation Systems,
Ch. 3, The Beginning of Directional Radio
Techniques for Air Navigation 1910-1940.
Journal of Navigation (Sept): 313-330.
Kocks, Katherine. 1990. Whats a Vertiport Look
Like Anyway? **Rotor & Wing International**.
(Feb): 30, 32-34.
Kroger, William. 1948. What's Ahead for
Airport Lighting. **AW** (May 31): 18, 21-25.
Landing Lightning. 1947. **Newsweek** (May 5):
59-60.
Latest Developments Keep Their Lustre. 1991.
AI (Oct): 21-22, 25.
Lighting the Night Airmail. 1926. **Literary
Digest** (July 31): 18-19.
The Lighting of Airports. 1928. **AC** (March):
104-106.
Lighting Up in the 1920s. 1990. **AI** (Sept): 40.
Lights as Aids to Aerial Navigation. 1922. **SA**
(Sept): 168.
Lights for Landing. 1949. **Newsweek** (March 7):

58.
Lights Squabble. 1949. **AW** (May 2): 14.
Lonely Watchers Who Guard the Nation's Skyways.
1931. **Literary Digest** (Oct 24): 39.
Making the Air Safe for Everybody. 1923.
Literary Digest (March 3): 58.
McKelvey, Robert K. 1987. Color Dependence &
Surplus Information in Airport Visual Aids
During VFR Operations. **Journal of
Navigation** (May): 206-226.
A Modern Airport Beacon. 1936. **SA** (Apr):
201-202.
Moore, F. Lee. 1950. The Way Out of Approach
Light Gloom? **AW** (Dec 11): 46-52.
More on Slopeline. 1955. **AW** (Sept 5): 74-75.
Mueller, Edward A. 1970. Aspects of the
History of Traffic Signals. **IEEE
Transactions on Vehicular Technology**.
(Feb): Vol VT-19 #1).
MLS: Setting the Future Standards. 1984.
AI (Aug/Sept): 31-33.
New High-Intensity Light For Airport Runways.
1947. **AC** (Dec): 167.
New Idlewild Approach System Designed to Ease
Landing Hazard. 1956. **AW** (Jan 23): 96-97.
New Hope for Standard Lighting. 1951. **AW**
(Oct 8): 16.
New Lighted Guide Path. 1948. **SNL** (Dec 11):
371.
New Policy? 1950. **AW** (Nov 20): 55.
The Night Mail in Reality. 1923. **Literary
Digest** (Sept 8): 16-17.
Normarc Keeps Faith with ILS. 1989. **AI**
(Jan/Feb): 25.
Norvell, W.C. 1940. Amber Lights for Runways.
Aviation (Apr): 54, 116.
_____. 1941. Modern Airport Lighting.
AC (Jan): 42-44.
Olsen, David. 1991-1. FANS Prepares for Global

Acceptance. **AI** (June): 12.
_____. 1991-2. Global Policies Urgent to
Avoid 21st Century Chaos. **AI** (July/Aug):
28-30.
_____. 1992. Ground Systems Still Reign
Despite GPS Challenge. **AI** (Apr): 36.
_____. 1990. New Generation Lost En
Route. **AI** (March): 37-42.
PAPI: What the Options Are. 1984. **AI**.
(Aug/Sept): 33-35.
Pilots, ATA Favor Centerline Lighting. 1952.
AW (July 14): 75-76.
Pilot's Guide. 1944. **Business Week**.
(Nov 11: 76).
Plenderleith, Ian. 1984. Clear Reliable
Guidance is Key to Taxiway Safety.
AI (Jan/Feb): 33.
Pollock, Duncan. 1990. Lighting Firms Focus
on Cost-Effectiveness. **AI** (Sept):
35-38.
Robson, R.C. 1959. Same Old Story. **AW**
(Feb 16): 43.
SAF, CAA Test Approach Lights. 1955. **AW**
(Dec 5): 131.
Safer Signs for London Stolport. 1989.
AI (Jan/Feb): 34.
Slope Line Light Approval Near. 1948.
AW (Dec): 15-16.
Sodium Lights for Safer Landings. 1939. **SA**
(Sept): 158.
Sonic Marker Beacon. 1933. **SA** (July): 32.
Stone, Irving. 1957. US Tests Flashing Approach
Lights. **AW** (March 25): 89-90.
Tugs & Steps Left Behind. 1985. **AI** (July):
28-31.
Underwood, David. 1987. Move Over VOR/DME,
Loran Begins Its Approach. **Rotor & Wing**
International (Dec): 34-36.
US Rule Change Boosts Sign Market. 1992. **AI**

(Sept): 46.
USAF Pilots Favor Centerline Lighting. 1957.
AW (Sept 9): 117, 119.
Walker, Charles. 1991. Less Light on the Road
to Cat 3. **AI** (Oct): 20-21.
World Airways: Control of Bases Nub of Rivalry
Shaping up as Powers Scan Postward
Prospects. 1943. **Newsweek** (March 1):
26-32.
Young, D.C. 1928. Aerial Highways & Their
Marking. **AC** (Nov): 127-129.

iii Governmental Organizations
(including book and journal entries)

Aerodromes, Air Routes, & Ground Aids Committee.
1953. **ICAO Bulletin** (Apr): 5-8.
Aerodromes, Air Routes & Ground Aids Division,
Fifth Session, Montreal, 21 Oct-20 Nov 1952.
ICAO Bulletin (Jan/Feb): 8-11.
Airports. 1953. **ICAO Bulletin** (June-July):
23-24.
Army Air Force. 1944. **Numbering & Marking
of Airfields Runways, Landing Strips,
& Taxiways**. TO # 00-25-7. (Aug 23).
Air Forces. 1944. **Numbering & Marking of
Airfield Runways, Landing Strips, &
Taxiways**. (Aug 23). TO # 00-25-7.
Army-Naval-Civil Committee on Aviation
Ground & Aerodrome Lighting. 1946.
**Army-Navy-Civil Uniform Requirements
for Lighting of Airways**. (June 27).
Australia. 1969. Letter from Wilson, C.B. to
compiler. (Dec 18).
_____. 1969. **Air Navigation Aids**.
_____. 1993. **Fact Book**. Canberra:
Civil Aviation Authority.
_____. c1991. **CAA Australia**.
_____. **Backgrounders** (leaflets on
various topics).

_____. 1992. **Enroute Supplement Australia** (AIP).

Belgium & Luxembourg. 1993. **AIP Belgium & Luxembourg**. Laventem, Belgium: Regie der Luchtwezen.

Berry, Norm. 1992. **New Specifications Proposed for Taxiway Guidance Signs**. **ICAO Journal** (Feb): 8-9.

Brown, Guy S. 1983. **Evaluation of Retroreflective Pavement Markers for Markers for Precision and Nonprecision Runways**. Atlantic City, NJ: FAA Tech Center. (Sept).

CAA. 1948. **Air Marking Guide**. Washington, D.C.: CAA.

CAA. 1941. **Airport Lighting**. Washington, D.C. GPO.

CAA. 1947. **Airport Lighting Maintenance Manual**. (Feb).

CAA. 1947. **Air Navigation Facilities Service: A Digest of the Programs & Appropriations for Air Navigation Facilities, 1927-1947**.

CAA. 1958. **Federal Airway Plan FY 1959-63**. (Jan).

CAA. 1942. **Specification for Code Beacons**. Washington, D.C.: CAA.

CAA. 1945. **Statistical Handbook of Aviation**.

CAA. 1948. **Standard Specifications for Construction of Airports**.

CAB. 1977. **Glossary of Air Transportation Terms**. Washington, D.C.: CAB.

Canada. 1992. **Air Navigation System Plan**. Ottawa: Transport Canada.

Canada. 1992. **Canadian Airspace Systems: Facilities, Equipment & Associated Development**. Ottawa: Transport Canada.

Clark, B.A.J., and Gordon, J.E. 1981. **Hazards of Color Coding in Visual Approach Slope Indicators**. Melbourne: Aeronautical

Research Labs.

Convention on the Regulation of Aerial Navigation. 1919. Vol I, 1919-1921. Paris. In **International Legislation: A Collection of the Texts of Multipartite International Instruments of General Interest** ed. by M.O. Hudson. NY: Carnegie Endowment for International Peace, 1931. Reprinted by Oceana Publications, Dobbs Ferry, NY, 1970. (Also Protocols 9a-9e 1920-1929).

Denmark. 1993. **AIP Danmark - Bindi 1**. Copenhagen: CA Administration-Denmark. **Development of Air Navigation Facilities**. 1953. **ICAO Bulletin** (June-July): 21-23. DOT & Agency for International Development. 1971. **Aids to Air Navigation in S.E. Asia**. Washington, D.C.

DOD. 1983. **Military Specification: Light Assembly, Marker, Aircraft Obstruction**. MIL-L-7830D. Sept 15. San Antonio TX: Engineering Div., San Antonio ALC/MMEDD, Kelley AFB TX.

_____. 1983. **Mil. Spec.: Light, Navigational, Beacon, Obstacle or Code, Type G-1**. Nov 9. MIL-L-6273D. Publisher: as above.

_____. 1963. **Mil. Spec.: Colors, Aeronautical Lighting Equipment, General Regulations for**. Dec 2. MIL-L-C-25050A (ASG). Lakehurst NJ: Engineering Specs & Standards, Naval Air Engineering Center.

DOT/DOD. 1990, 1992. **Federal Radionavigation Plan**. Washington D.C.: DOD & DOT.

European Civil Aviation Conference. 1956. **ICAO Bulletin**. Strasbourg, 29 Nov-16 Dec.

FAA. 1991. (AIP) **Aeronautical Information Publication**. FAA: Washington, D.C.

FAA. 1973. (AIM) **Airman's Information Manual**. Part 1, Basic Flight Manual & ATC

Procedures.

- FAA. 1991. (AIM) **Airman's Information Manual: Official Guide to Basic Flight Information & ATC Procedures.** July 25.
- FAA. 1989-9. **Airport Design.** AC 150/5340-13. (With Change 1, 6-5-91). Sept 13.
- FAA. 1969-10, 1971-11, 1973-9, 1980-3. **Airport Design Standards--Site Requirements for Terminal Navigation Facilities.** A/C 150/5300-2A, -2B, -2C, & -2D.
- FAA. 1970-6. **Economy Approach Landing Aids.** AC 150/5340-14B.
- FAA. 1991-7. **Facility Operations & Administration.** 7210.3J. July 25.
- FAA. 1971-5. **Flight: The Story of Electronic Navigation.** Oklahoma City: FAA Academy.
- FAA. 1988-1. **Generic Visual Glide Slope Indicators (CVGI).** A/C 150/5345-52. June 21.
- FAA. 1988-2, 1994. **Heliport Design.** A/C 150/5390-2, Jan 4, and A/C 150/5390-2A, Jan 20.
- FAA. 1971. **Instrument Flying Handbook.** AC 61-278.
- FAA. 1986-7. **Maintenance of ILS.** 6750.49. July 15.
- FAA. 1990-8. **Microwave Landing Ground System Turnkey Facility Establishment.** Aug 30.
- FAA. 1991-8. **Obstruction Marking & Lighting.** A/C 70/7460-1H with Ch 1. Aug 1.
- FAA. 1985-5. **Precision Approach Path Indicator (PAPI) Systems.** A/C 150/5345-28D. May 23.
- FAA. 1980-6, 1988-7. **Specifications for Obstruction Equipment.** A/C 150/5345-43C, June 10, and A/C 150/5345-43D. July 15.
- FAA. 1984. **Specifications for Runway and Taxiway Light Fixtures.** A/C 150/5345-46A June 7.

- FAA. 1985-6. **Site Criteria for ILS.** June 17.
- FAA. 1959. **Standard Specifications for Construction of Airports.** /AC 150/5370-1.
- FAA. 1992. **Summary of the FAA's Future Navigation Mix (Through 5-92) Evaluation.** MF.
- FAA. 1974-10. **Visual Guidance Lighting Systems Handbook.** 6850.2 with Chs 1-7). Oct 16. (Reprinted).
- FAA. 1986-4. **VOR, VOR/DME & VORTAC Siting Criteria.** 6820.10. April 17.
- Final Reports.** 1949. Air Force-Navy-Civil Landing Aids Experiment Station. Arcata CA. Fifth Session of the Communication Division, Montreal, 9 Mar-9 April 1954. **ICAO Bulletin.** May.
- France. 1993. **AIP France** (En Route Charts, Lower, Upper Airspace). Paris: Service de L'Information Aeronautique.
- Germany. 1992. **Jahresbericht '92 der Bundesanstalt fur Flugsicherung** Offenbach: Deutsche Flugsicherung.
- _____. ud. **Klassifizierung des Luftraums nach ICAO.** Offenbach: DF.
- _____. 1992. **Hochstleistung fur Flugsicherheit.** Offenbach: DF.
- Gilbert, M.S. 1947. **A Low Cost Boundary Lighting System for Small Airports.** TDR # 53. Aug. Washington, D.C.: CAA.
- Hromada, J.C. 1940. **Four-Course UHF Radio Range.** TDR # 3. Jan 1938. Washington, D.C.: GPO.
- ICAO, International Civil Aviation Organization. 1983. **Aerodrome Design Manual** (Part 4, Visual Aids). Montreal.
- _____. 1951. 1st. **Aerodromes.** (International Standards & Recommended Practices, Annex 14).
- _____. 1953. 2nd ed. **Aerodromes.** 2nd ed.

- ___ . 1958. 3rd ed. **Aerodromes**. 3rd ed.
- ___ . 1964. 4th ed. **Aerodromes**. (& Amd 20).
- ___ . 1969. 5th ed. **Aerodromes**.
- ___ . 1971. 6th ed. **Aerodromes**.
- ___ . 1976. 7th ed. **Aerodromes**. (& Amds 31, 32).
- ___ . 1983. 8th ed. **Aerodromes**.
- ___ . 1990. 1st ed. **Aerodromes**. (Vol I, Aerodromes; Vol II, Heliports).
- ___ . 1949. **Aeronautical Telecommunications**. (Standards & Recommended Practices, Annex 10 to and including 2nd ed).
- ___ . 1950. **Aeronautical Telecommunications**. (1st ed).
- ___ . 1951. **Aeronautical Telecommunications**. 2nd ed.
- ___ . 1952. **Aeronautical Telecommunications**. 3rd ed. (International Standards & Recommended Practices, Annex 10 to present).
- ___ . 1958. **Aeronautical Telecommunications**. 5th ed.
- ___ . 1960. **Aeronautical Telecommunications**. 6th ed.
- ___ . 1963. **Aeronautical Telecommunications**. 7th ed.
- ___ . 1965. **Aeronautical Telecommunications**. 1st ed, Vol I, Part I, Part II.
- ___ . 1968. **Aeronautical Telecommunications**. 2nd ed, Vol I, Part I, Part II.
- ___ . 1972. **Aeronautical Telecommunications**. 3rd ed, Vol I, Part I, Part II.
- ___ . 1985. **Aeronautical Telecommunications**. 4th ed, Volume I, Parts I, II.
- ___ . 1985. Supplement to Annex 10, Vol I, 4th ed. (& Amd-1, 1987, Amd-2, 1991).
- ___ . 1991. Supplement to Annex 14, Vol I Aerodrome Design & Operations, and Vol II Heliports;
- ___ . 1965. Supplement to Annex 14, 4th ed.

- ___ . 1975. Supplement to Annex 14, 6th ed.
- ___ . 1978. Supplement to Annex 14, 7th ed.
- ___ . 1955. Supplement to Volume I-X, General Index. **ICAO Bulletin**.
- ___ . 1990. Annual Report. **ICAO Journal** (July): 24-25, 28.
- ___ . 1992. Annual Report. **ICAO Journal**. (July): 19-20.
- ___ . 1986. **Lexicon**. 6th ed.
- ___ . 1950. **Index of ICAO Documents**. Special Issue. PICA & ICAO Assembly Documentation. 1946 & 1950.
- IHB, International Hydrographic Bureau. 1965 **Radio Aids to Maritime Navigation & Hydrography**. 2nd ed. Monaco: IHB.
- International Civil Aviation Conference. 1944. **Proceedings of the ICAC**. Chicago.
- Jones, Paul H. 1989. **Heliport Identification Beacon**. April. Atlantic City: FAA Tech Center. (microfiche).
- Katz, S. 1989. **Improved Marking of Taxiway Intersections for IFR Operations**. Atlantic City, NJ: FAA Tech Center.
- Komons, Nick. 1978. **Bonfires to Beacons: Federal Civil Aviation Policy Under the Air Commerce Act, 1926-1938**. Washington, D.C.: FAA.
- Lee, J.M. & Metz, H.I. 1947. **The Development of a Straight-Line Glide Path**. TDR # 55. June.
- List of International Agreements Concerning Aviation Prior to January 1, 1930. **American Journal of International Law**. Vol 24 Supplement Volume, 1930. 161-168.
- Mexico. 1992. **Espacio Aero Supevia**. Mexico City: Aeronautica Civil.
- NATO. 1991. **Airfield Lighting**. STANAG 3316. Brussels: NATO Military Agency for Standardization.

Navy Dept, Bureau of Aeronautics. 1946.
NavAer Design Manual. Washington, D.C.
Naval Facilities Engineering Command (U.S.).
1981. **Airfield Lighting**. Design Manual
23.1. Alexandria VA. July.
Norway. 1993. **AIP Norge/Norway**. Oslo: CAA/
Luftfartsverket.
O'Brien, Arthur E. 1983. **History & Status of
U.S. Marine Radiobeacon System**. Cambridge
MA: USDOT Transportation Systems Center &
Washington, D.C.: US Coast Guard Office of
Navigation.
Rochester, Stuart I. 1976. **Takeoff at Mid-
Century: Federal Civil Aviation Policy in
the Eisenhower Years, 1953-1961**.
Washington, D.C.: FAA.
Second Air Navigation Conference. 1955. **ICAO
Bulletin**. 31 Aug-27 Sept. Dec.
Singapore. ud. **Singapore ATC -- At the Cutting
Edge of Technology**. Singapore: CAA of
Singapore.
Spain. 1993. **Instalaciones de Radionavegacion**.
Madrid: Direccion General de Aviacion Civil.
Sweden. 1994. **AIP Sweden**. Norrkoping: Luftfarts-
verket.
Switzerland. 1993. **Radio Facility Index**. Bern:
Federal Office for Civil Aviation.
Taiwan. 1992. **AIP-Taipei FIR**. Taipei: CAA.
Thacker, J.R. 1984. **An Evaluation of Flashtube
Signal Characteristics**. USDOT, USCG. CG-D-
2684. Aug.
UN. 1969. **Convention on Road Signs & Signals**.
Vienna. UN Conference on Road Traffic.
UN. 1989/1990. **Statistical Yearbook**. New York.
Venezia, Krisen, & McConkey, Edwin. 1985.
**Microwave Landing Systems for Heliport
Operators, Owners, Users**. West Palm Beach
(FL): Systems Control Technology. (US DOT,
FAA).

U.S. House of Representatives, Committee on
Science & Technology. 1984. **Aircraft
Navigation & Landing Technology:
Status of Implementation**. July 24.
Washington, D.C.: GPO.
Whittenberg, J.A. et.al. 1964. **Airport/
Heliport Markings & Lighting Systems:
A Summary Report on Human Factors**.
Research Prepared for FAA Systems Research &
Development Service. McLean, VA: Human
Sciences Research, Inc.
Wigmore, B.T., NATS. 1993. Letter to writer.
Sept 15.
Wilson, John R.M. 1979. **Turbulence Aloft: The
CAA Amid Wars & Rumors of Wars, 1938-1953**.
Washington, D.C.: FAA.
Wilson, A. 1993. Letter to writer. March 10.
NATO.

iv Trade Literature

ADB. 1991. **Aviation Lighting Systems**
Zaventem, Belgium: N.V. ADB S.A.
Airflo Instrument Co. 1985. **Dual
Mode HI Approach Lighting System
(ALSF-2/SSALR)**. Glastonbury, CT. (FAA
Contract).
Alcatel SEL. ud. **A Global Approach to
Air Navigation, Nav aids**. Stuttgart.
Ameriel. 1989. (Strobe Light). Atlanta.
Cegelec. 1992. **Airport Ground Lighting
Equipment**. Rugby UK & Levallois-
Peret, France: Cegelec Projects.
Crouse-Hinds. 1962. **Aviation Lighting
Equipment**. Syracuse, NY.
_____. 1991. **Crouse-Hinds
Airport Lighting Products**. Windsor, CT.:
Crouse-Hinds Airport Lighting Products.

Danaid. 1991. **Airport Lighting & Electronic Systems**. Vaerloese, Denmark: Danaid of Denmark A/S.

Devore. 1991. (Catalogue folder containing unbound materials). Albuquerque: Devore Aviation Company.

EG&G. 1992. (Catalogue: folder containing unbound inserts & articles). Salem, MA.: EG&G Electro-Optics.

General Electric. 1966. **Airport Lighting**. Hendersonville, NC.

Godfrey Engineering. ud. **Airport Lighting**. Tampa, FL.

. 1987. **Instruction Book, Runway End Identifier Lighting System**. (FAA Contract). Tampa.

. 1985. **Medium Intensity Lighting Systems (MALS)**. Tampa. (FAA Contract).

GTE Sylvania. 1978. **Instruction Book, Visual Approach Slope Indicator System**. Salem, MA.

Hughey & Phillips. ud. **Airport Lighting Equipment**. Burbank, CA.

. ud. **Towers & Obstruction Lighting**. Simi Valley, CA.

Idman. ud. **Airfield Lighting**. Mantsala, Finland: Slo-Idman Oy.

ITT Avionics. 1969. **AN/URN -20 TACAN Beacon System**. Nutley, NJ.

Jaquith. ud. (Catalogue materials). Syracuse, NY: Jaquith Industries.

Mannairco. 1993. (Airport/heliport Lighting catalogue materials). Mansfield, OH.

Martin Marietta. ud. (Poster). Bethesda, MD.

Multi-Electric Mfg Inc. 1974. **Instruction Book, MALS Medium Intensity Approach Lighting System with Runway Alignment Indicator Lights**. Chicago. (FAA Contract).

. c1986. **Instruction Book, PAPI**. (FAA Contract).

. 1978. **Instruction Booklet - Visual Approach Approach Indicator**. (FAA Contract).

. c1984. **Semi Flush Approach Lighting 20 AMP Watt Light** Contract to FAA. Chicago.

Nautel. c1991. (Catalogue materials). Tantallon, Nova Scotia, Canada: Nautical Electronic Labs.

Omnipol/Tesla. ud. **Airport Lighting Equipment D3**. Praha/Prague: Tesla Works Electrosignal & Omnipol Foreign Trade Corp.

Pharos. ud. **Aids to Navigation**. Brentsford Mdsx, U.K.: AB Pharos Marine Ltd.

Sepco. 1971. **SAVASI**. Bulletin 5.1. Windsor, CT.: Sepco Div., Connecticut International Corp.

Sylvania. 1964. **Series CD2500 Condenser Discharge Lighting**. Ipswich, MA.: Sylvania Electric Products.

Thorn. 1992. **Thorn: A Master of Airfield Lighting**. Paris: Thorn Europhane.

Toshiba. ud. **Air Traffic Control & Navigation Systems**. Tokyo: Electronics Div, Toshiba Corp.

Tull. 1975. **Microwave ILS**. Armonk, NY: Tull Aviation Corp.

. c1975. **Questions & Answers for Potential Users of the Interim Standard MLS**. Armonk NY: Tull Aviation Corp.

TWR Lighting. 1991. **Catalog**. Houston.

Ulmer. ud. **Balisage de Piste**. Paris: Ulmer Aeronautique.

Unitron. c1980. (Catalogue materials). Atlanta: Visual Vector Div, Unitron International Systems.

Valley Illuminators. 1992. **Special Bulletin-
Upgrades-New Products**. Tukwila, WA.
Vega Industries. ud. (Catalogue materials).
Syracuse, NY.
Westinghouse. 1961. (Catalogue excerpts).
Cleveland OH: Westinghouse Electric Corp.
Wilcox. 1993. **Guided by Commitment**. Kansas
City, MO: Wilcox Electric, Inc..

v Miscellaney

ATA Airline Airport Design Recommendations.
1946. Washington, D.C.: Air Transport
Association of America.
Breckinridge, F.C. 1955. **Fifty Years of
Signal Lighting**. New York: IES.
Communications Satellites. 1992. **McGraw-
Hill Encyclopedia of Science &
Technology**. Vol 4, Cli-Cyt.
Douglas, Charles. 1977. Letters to compiler,
Nov 20 and Dec 28.
Satellite Navigation Systems. 1992. **McGraw-
Hill Encyclopedia of Science &
Technology**. Vol 16, Sab-Son. New York:
McGraw-Hill.
V/STOL in Civil Aviation. 1970. Technical
Symposium, British Air Lines Pilots.
London. 24-26 Nov.

Aeronautical Navigation Aids: ICAO, importance
to aero aids, 4; International character of
aero aids, 3, 4; Messages, 13; Methodology, 1,
5; Nature of, 1, 2, 3, 14, 15; Physical
Properties, 9-14; Semiotics, 10-14; Statistics,
5-9; Terminology, viii, 1, 2, 9; Unified
Subject, viii.
See Also: Radio Aids and Visuals Aids,
Classification, History, Messages.
Classification, viii; Main: introduction, 49-51;
Classification, 51-54; Explanatory notes, 54-59
(all-lighted, 55-55, partially-lighted, 55-58,
special dual classification, 58, unlighted,
58-59; radio aids, 59). Variant: Classifi-
cation, 60-63; Explanatory notes, 63-71
(approach lighting, 63-65, final approach,
65-68, runway & taxiway, 68-69, obstruction,
69-71, beacon, 71.
SEE ALSO: Illustrations.
History, viii. Introduction & Early Aviation,
16-17. Early Nav Aids: 20-31 (Aerial Light-
houses, 24-25; Boundary Lights, 20-22;
Messages, 20-23; Obstruction Lights, 22;
Beacons, 23-26; Wind Indicators, 26; Signs &
Markings, 26-27; Acoustic Signal, 28; Radio
Aids, 27-31). 1938-1943 Developments: 32-36
(Boundary, Runway & Taxiway, Strip, Range,
Threshold Lights, 32-33; Taxiway Light, 33;
Approach Lights, 33-34; Fixed Approach Lights,
34; Runway Lights 34-35; Beacons, 35; Radio
Aids, 35-37). 1944-1950 Developments: 37-48
(Approach Lights, 37-40; Runway Lights, 40-41;
Threshold & TDZ, 41; Radio Aids, 41-42;
International Cooperation, 41-44). Epilogue:
Approach Lighting, 44-48.
Illustrations, 72-77; Explanatory Notes, 78-83.
Messages, Production of, 13; Nature of, 14-15;

Forms of, 13.
SEE ALSO: Visual Aids and Radio Aids.
Physical Properties, 9-14.
Radio Aids (Electronic Aero Aids), vii. Overview and changes, 139-142; ILS, 142-145 (Purpose, 142-143, Localizer, 143, Glide Slope, 143-144, Marker Beacon, 144-145, Locator, 145). MLS, 145-147. Beacons, 151-153. Consul, Loran & Satellite Navigation, 153-155. VOR, DME, TACAN, & VORTAC, 148-151. Peripheral Aids, 156-158 (Delrac & Dectra, 156-157; Navaglobe & Navrho, 156, 157-158, GEE, & VHF Multi-track Pulse Range, 158).
Semiotics, vii, 9-14.
Transportation Markings, General, vii, 10, 12. Other Modes: Marine Aids to Navigation, vii, 1, 4, 12, 13, 15, 24, 25, 50, 57, 93, 112, 113, 121, 132, 134; Railway Signs & Signals, vii, 1, 4, 5, 12, 14, 15, 49, 131; Traffic Control Devices, vii, 1, 4, 15, 58, 81, 131.
Visual Aids, Lighted: vii, viii. Approach Lighting, 85-91 (Introduction, 85-87; Equipment, 87-89; Messages, 89-91). Final Approach Indicators, 92-100 (Introduction, 92-93, Messages, 93-99; Equipment, 99-100). Runway & Taxiway Lights, 101-111 (Background, Terminology and Functions, 101-102; Inset Lights, 102-105; Elevated Lights, 105-107; Messages, 107-111). Beacons & Obstruction Lighting, 112-119 (Introduction, 112-113; Beacon Equipment, 113-115; Obstruction Lighting Equipment, 115-118; Beacon & Obstruction Messages, 118-119).
Visual Aids, Partially-Lighted & Unlighted: Introduction, 121-123; Sign Types & Messages, 123-124; Marking Types & Messages, 124-128 (Runway-related, 124-127; Taxiway-related, 127-128); Indicators, 129-130; Marker Types & Messages, 130-134; Obstruction Marking Types & Messages, 134-136; Restricted Use Area Visual Aids, 136-137.

INDEX OF AERO NAVIGATION AID PHENOMENA

- AAI, xii, 68.
- Aerial Lighthouses, 18, 24, 25.
- Aerial Lighting, 24.
- Aero Aids, vii, 1, 3, 5, 12, 13, 14, 16, 17, 18, 28, 37, 50, 78, 93, 122, 129, 134, 141, 159.
- Aero Identification Signs, 124.
- Aero Lights/-ing, 16, 20, 23, 50, 55, 64, 85, 106, 113.
- Aerodrome Beacons, 25, 52, 113, 115, 145, 162.
- Aerodrome Lighting & Marking, 2.
- Aero Markers, 131.
- Aero Markings, 26.
- Aero Navigational/-al Aids, 1, 2, 4, 10, 12, 13, 15, 16, 20, 32, 43, 50, 84, 98, 103, 107, 121, 140, 143, 159.
- Aero Signs, 27.
- Aerodrome Beacons, 26, 56.
- Aerodrome Identification Signs, 52, 81, 112, 148, 165.
- Aids, 3, 13, 14, 28, 29, 31, 35, 45, 50, 55, 58, 59, 129, 134, 140, 141, 142, 153, 156.
- Aids for Restricted Areas, 160.
- Aids to Final Approach & Landing (Radio), 166.
- Air Markers, 27.
- Aircraft Markings, 53.
- Aircraft Stand Identification Signs, 52, 124, 148, 165.
- Aircraft Stand Maneuvering Guidance Lights, 109, 110.
- Aircraft Stand Markings, 127, 128, 163.
- Airfield Aids, viii.
- Airfield Lighting & Marking, 2.
- Airfield Lights/-ing, 2.
- Airport Aids, viii, 55.
- Airport Ground Lighting, 2.
- Airport Identification Beacon, 67, 103.
- Airport Lights(-ing), 1, 32, 55, 101, 102, 112.
- Airway Beacons, 20, 24, 27, 28, 33.
- Airway Lighting, 24.

ALSF-I, ALSF-II, xii, 61.
AOE, xii, 62, 63, 94, 98.
Angled Approach Lights, 38.
Angle-of-Approach Lights, 160, 161.
APAPI, xii, 61, 66, 97, 99, 144, 160.
Approach Aids, 13.
Approach Day Markers, 162.
Approach Day Marker System, 162, 165, 166.
Approach (Radio) Aids, 28.
Approach Lighting, 14, 21, 33, 34, 37 38,
45, 46, 48, 51, 54, 56, 60, 63, 65, 72,
80, 84, 85, 86, 87, 89, 90, 105, 107, 111, 112,
160, 161.
Approach Lighting System Type "A", 160.
Approach Lighting System for Runways with
Neither Stopways nor Displaced Thresholds,
160.
Approach Lighting System with Displaced
Threshold, 160.
Approach Lighting System with Stopway, 160.
Approach Slope Indicator Systems, 98.
Apron Safety Lines, 53, 128.
ASMGL, 145.
AT-VASIS, xii, 61, 67, 95, 160.
Auxilliary Beacon, 23, 24.
AVASIS, xii, 61, 66, 95, 160.
Aviation Aids, 3.
Aviation Aids Lighting, 2.
Azimuth Station, 54.

Back Course Beacon, 145.
Balisor Lamp, 116.
Barrettes, 65, 86.
Bartow Light, 34, 36, 38.
Beacons, 22, 23, 24, 25, 29, 35, 36, 52, 55,
56, 62, 70, 71, 78, 80, 101, 112, 113, 114,
116, 118, 140, 145, 151, 162.
Blister Lights,
Border Lights, 20.
Boundary Day Markings, 146.
Boundary Lights, 20, 21, 22, 27, 32, 33, 34.

35, 101, 111, 162.
Boundary Markers, 53, 81, 133, 134, 165.

Calvert Light(s), 39.
Capacitator Discharge Light, 51, 54, 84, 85, 88,
89, 114, 116.
Category II Holding Position Signs, 165.
Category II/III Holding Position Markings, 164.
Category II/III Holding Position Signs, 123,
165.
Caution Bars,
Centerline Lights, 36, 37, 39, 44, 45, 46, 51,
101.
CHAPI, xii, 61, 66.
Chevron Markings, 164.
Circle Markers, 27.
Clearance Bars, 15, 52, 93, 101, 109, 161, 164.
Closed Markings, 136, 148, 164.
Closed Runway Aids, 136.
Closed Taxiway Aids, 136.
Code Beacon, 23, 56, 80, 114, 116, 118.
Colors, 164.
Compass Locator, 82, 143, 145, 152.
Condenser Discharge Light, 39.
Cone Markers, 153, 165.
Consul, 54, 59, 149, 153, 154, 156, 166.
Contact Lights, 34.
Course Light, 23.
Course Setter, 30.
Crossbar Lights, 42.

Day Aid, 127.
Day Markers, 134.
Day Markers for Snow-Covered
Runways, 163.
Day Marking (Aero) Marker, 165.
Day Marking Aids, 163.
Day Marking -- Landing Aids, 163.
Day Marking (Marker Form), 165.
Day Marking (Markers) of Snow-
Covered Runways, 163.

Day Marking of Snow-Covered Runways, 163.
Day Marking -- Taxying Aids, 164.
DBGA, xii, 68.
DECCA, 157.
DECTRA, 156, 157, 167..
DELAC, 156, 167.
Differential GPS (DGPS), 156.
Directional Arrows, 27.
Directional Beacon, 30, 151.
Directive Beacon, 30.
Discharge Light,
Displaced Runway Threshold Markings, 163.
Displaced Threshold Markings, 163.
Distance Arrows, 27.
Distance-to-go Markings, 163.
DME, 39, 54, 141, 142, 143, 148, 149, 150, 151, 166.
DME/P, 147, 149, 166.
DME/N, 147, 149, 166.
DME/W, 147, 149, 166.
DVOR, 151.

Edge Lights, 51.
Edge Markers for Snow-Covered Runways, 165.
Electronic Aero Navigation Aids, 139.
Electronic Aids, 1, 59, 82, 139.
Electronic Navigation Aids, 53, 59, 77.
Elevated Lights, 62, 68, 80, 101, 105, 106, 107.
Elevation Station, 54.
End Lights, 51.
En-route VHF Marker Beacon, 54, 55, 149, 166.
Exit Taxiway Center Line Lights on High Speed Exit Taxiways, 161.
Exit Taxiways Center Line Lights on Other Exit Taxiway, 161.

Fan Markers, 153.
Final Approach Glide Slope Indicator, 34.
Final Approach Indicators, 51, 57, 65,

68, 85.
Final Approach Lights, 54, 56, 60, 61, 72, 81, 92, 93, 99, 111, 112, 160.
Fixed Distance Lights, 161.
Fixed Distance Markings, 53, 126.
Fixed Lights, 87, 90, 100.
Flag Markers, 53, 59, 122, 135, 136, 164, 165.
Flashing Beacon, 25.
Flashing (Strobe) Lights, 37, 47, 60, 63, 66, 80, 85, 86, 87, 88, 89, 90.
FLOS, xii, 68, 94.
Fresnel Beacon, 115, 116.
Fresnel Obstruction Beacon, 114.
Fully-Lighted Aids, 57.

GAIL, xii, 67.
GEE System, 158, 167.
Glide Slope, 142, 143, 144, 166.
Glide Path Indicator, xii, 30, 36, 53, 61, 66, 149.
GLISSADA, 67, 94.
GLONASS, 129, 154.
GNSS, 129, 142, 154.
GPS, 129, 154, 155.
Ground Aids, viii, 2, 54.
Ground-based Aids, 2.
Ground Signal Panel, 165.
Guidance Aids, 28, 29.
GVDI, xii, 68.
GPI, 68, 98.
GVGI, xii.

HAPI, xii, 67, 160.
HAPI-PLASI, 51, 55, 61, 67, 68.
H-PAPI, 61, 66, 97.
Hazard Beacon, 24, 114, 162.
Helicopter Approach Lights, 161.
Heli-Plasi, 55, 61, 67.
Helicopter Final Approach & Takeoff Area Lights (edge), 52.

Helicopter Touchdown & Landing Area Lighting Systems (edge), 52.
Helideck Markings, 53.
Heliport Air Taxiway Markings, 53.
Heliport Beacon, 52, 56, 113.
Heliport FATO Markings/Markers, 53.
Heliport Identification Markings, 53.
Heliport Lights, 111.
Heliport Markings & Markers, 53, 59, 111.
Heliport Mass Markings, 53.
Heliport Name Markings, 53.
Heliport Taxiway Markings, 53.
Heliport TD Markings, 53.
High Intensity Beacon, 58, 67.
High Intensity Lights, 87.
High Intensity Obstruction Light, 52, 56, 115, 118, 119.
High Intensity Runway Edge Lights, 97.
High Intensity Unidirectional Elevated Lamp/Lights, 51, 60.
High Intensity Unidirectional Lamp, 56.
Holding Position Light, 52, 101, 106, 123.

Identification Beacon, 52, 111, 113, 114, 115, 116, 118, 162.
Identification Markings, 111.
Illuminated & Non-Illuminated Signs, 52.
ILS, 30, 36, 39, 41, 49, 53, 59, 82, 140, 141, 142, 143, 144, 146, 147, 151, 152, 153, 166.
ILS Locators, 141.
Identification of Stand, 115.
Independent Aids, 53, 59, 148.
Inner (Marker) Beacon, 144, 145.
Information Signs, 52, 81, 124, 165.
Indicators, 34, 52, 53, 57, 62, 65, 68, 92, 122, 129, 162.
Inpavement Lights, 55, 57, 109.
Inset Lights, 55, 57, 74, 78, 88, 101, 102, 104, 105, 107.

Landing Aid Lights, 101.

Landing Aids, 55.
Landing Aerodromes without Runway Day Marking, 163.
Landing Direction Indicators, 52, 57, 81, 162.
Landing Direction Lights, 111.
Lead-in-Lighting System for Runways with Neither Stopways nor Displaced Thresholds, 161.
Lead-in-Lights, 88, 161.
Lead-in-Line, 115.
Lead-out-Line, 115, 116.
Light Bar, 65, 86.
Lighted Aero Aids, 85.
Lighted Aero Nav Aids, 85.
Lighted Aids, 14, 121, 131, 134, 139, 159.
Lighted Airway, 18.
Lighted Precision Descent Indicators, 129.
Lighted Signs, 51.
Lights/-ing, 20, 21, 26, 32, 33, 50, 55, 63, 64, 68, 85, 89, 90, 91, 92, 101, 102, 104, 110, 111, 112, 115, 118, 119, 166.
Locator, 143, 149, 166.
Localizer, 30, 53, 142, 143, 144, 149, 166.
Long Distance Aids, 166.
Loran, 140, 149, 153, 166.
Loran-A, 53, 59, 149, 154, 166.
Loran-C, 142, 154.
Low Intensity Edge Light, 97.
Low Intensity Light, 31.
Low Intensity Obstruction Light, 52, 56, 62, 63, 70, 115, 119, 146, 162.
Low Intensity Omnidirectional Light, 60.
Low Powered Fan Markers, 153.

MALSF, xii, 61.
MALSR, 61.
Mandatory Instruction Signs, 52, 81, 123, 165.
Marker Beacon, 30, 35, 53, 82, 144, 145, 149, 153, 166.
Marker Boards, 137.
Marker Lights, 34.
Markers, 27, 33, 50, 53, 58, 76, 81, 122, 129,

130, 131, 132, 134, 136, 137, 146, 147, 162,
164, 165, 166.
Markers (Radio), 139.
Marking Aids, 146.
Marking of Snow-Covered Runways, 147.
Markings, 14, 27, 49, 53, 58, 63, 76, 81, 102,
110, 119, 122, 123, 124, 131, 134, 137, 162,
166.
Markings (Non-sign), 54, 77.
MDLA, xii, 68, 94.
Medium Intensity Approach Lighting, 84, 87.
Medium Intensity Beacon, 71.
Medium Intensity Obstruction Lighting, 56, 62,
63, 69, 70, 79, 80, 115, 117, 119, 162.
Medium Intensity Omnidirectional Lighting, 60.
Medium Intensity Omnidirectional Elevated
Light/-ing, 51.
Medium Intensity Runway Edge Lights, 49.
Medium Intensity Unidirectional Approach Lights,
87.
Middle Locator, 145.
Middle Marker Beacon, 145.
Mini-PAPI, 98.
MLS, 58, 59, 82, 140, 142, 145, 146, 147, 151,
155, 166.
Multi-mode Radio Aids, 140, 151.

Navaglobe-Navarho, 156, 157, 158, 167.
Navigation/-al Aids, viii, 1, 2, 3, 28, 42, 49,
111, 139, 140.
NDB, 28, 54, 59, 139, 141, 142, 145, 149, 151,
152, 166.
Neon Discharge Lamp, 115.
Neon Obstruction Lights, 66.
No Entry Signs, 81, 123.
Non-Obstruction Aids, 159.
Non-load Bearing Surface Aids, 136, 137.
Non-load Bearing Surface Markings, 137.
Non-sign Markings, 58, 131, 134.

Obstacle Lighting, 86, 101, 112.

Obstruction Aids, 13, 143, 159.
Obstruction Beacons, 101, 105.
Obstruction Colors, 147.
Obstruction Flags, 147.
Obstruction Light/-ing, 21, 22, 52, 56, 62, 70,
73, 79, 112, 113, 114, 115, 116, 117, 118, 164.
Obstruction Markers, 147.
Obstruction Markings, 53, 59, 76, 81, 113, 121,
123, 129, 131, 134, 135, 164.
ODALS, 61.
OMEGA, 140, 142.
Omnidirectional Flashing Lamps/Lights, 60, 86.
Omnidirectional Lighting, 89, 112.
Omnidirectional Medium Intensity Lights, 54.
Omnidirectional Simplified Approach Lighting,
80.
Optical Localizer, 100.
Optical Projector Ground Aids, 68.
Outer Localizer, 133.
Outer Marker Beacon, 144, 145.

PAPI, xii, 34, 61, 66, 67, 81, 94, 97, 99, 160.
Parking Aid, 52.
Parking & Docking Systems, 102.
Parking Lights, 102.
Partly Integrated Aids, 51, 54, 59, 148.
Partially Integrated Systems, 128.
Partially Lighted Aids, 54, 57, 123.
Patterns, 53, 135, 164.
Paved Day Markings, 163.
Paved Runway Day Markings, 163.
Paved Runway Markings, 163.
Paved Taxiway (Day) Markings, 164.
Pavement Markings, 14, 15, 27, 50, 134.
PCOLA, xii, 64.
P-DME, 147.
Perimeter Lights, 111.
PLASI, xii, 55, 68, 81, 93, 94, 98, 100.
Point-Source Aids, 140.
POMOLA, xii, 68.
Precision Approach Category I Lighting System,

161.
Precision Approach Category II Lighting System, 161.
Precision Approach Category II & III Lighting System, 161.
Precision Approach Lighting Systems, 60, 61, 161.
Precision Approach Runway Approach Lighting System, 144.
Pre-threshold Area Aids, 136.
Pre-threshold Markings, 137, 164.
Pulsed Code Aids, 67.
Pulsed Code Optical Landing Aids, 68.
PVG, xii, 94.
Radio Aids, vii, viii, 9, 16, 18, 28, 35, 41, 59, 139, 144, 149, 152, 159, 166.
Radio Beacons, 29, 149, 166.
Radio Marker Beacons, 28.
Radio Navigation Aids, 1, 2, 29, 42.
Radio Ranges, 29, 30, 39, 41, 148.
RAILS, xii, 60, 64.
Range Beacon, 25.
Range Lights, 21, 32, 36, 162.
Reflective Delineators, 33.
Reflective Markers, 133.
REILS, xii, 60, 64, 85, 89, 107.
Restricted Use Area Markings, 123, 129, 136, 159.
Retroreflective Markers, 133.
RILS, xii, 60, 64.
Rotating (Radio) Beacon, 28, 29.
Routing Beacon, 24.
RT-VASIS, xii, 67, 96.
RTILS, xii, 60, 64, 85, 89, 107.
Runway & Taxiway Elevated Lights, 51.
Runway Caution Zone Markings, 163.
Runway Centerline Lights, 108, 161.
Runway Centerline Marking, 53, 125, 163.
Runway Designation Markings, 51, 53, 163.
Runway Edge Lights, 32, 45, 51, 62, 64, 68, 69, 83, 101, 102, 106, 161.

Runway Edge Markers, 77.
Runway Edge Markings, 163.
Runway Edge/Threshold Lights, 101.
Runway End Lights, 34, 35, 52, 108, 161.
Runway Inset (Inpavement) Lights, 51, 70.
Runway Lights, 20, 32, 34, 38, 40, 41, 55, 62, 64, 69, 74, 92, 101, 102, 106, 161.
Runway Longitudinal Markings, 163.
Runway Markings, 42, 146, 162.
Runway Side Stripe Markings, 53, 126, 163.
Runway Threshold & Wing Bar Lights, 161.
Runway Threshold Lights, 51, 108, 161.
Runway Threshold Markings, 163.
Runway TDZ Lights, 109.
R/W VASIS, 93, 94.

Safety Aids, 4.
SAVASIS, xii, 61, 66.
Sequenced Flashing Lights, 91.
Semi-Buried Lights, 57.
Semiflush Lights, 32, 38, 41.
Short Distance Aids, 166.
Short Range Aids, 158.
Side Stripe Markings, 163.
Signage, 26.
Signing Aids, 165.
Signing Devices, 165.
Signs, 14, 15, 50, 52, 58, 76, 81, 102, 122, 123, 131, 162, 164.
Signs Providing Other Information, 124.
Simple Approach Lighting System, 60, 84, 90, 144, 145, 161.
Simplified Type Approach Lighting System, 57.
Sloped Approach Lighting, 36, 38, 39, 40, 45, 66, 94.
Snow-covered Runway Edge Markers, 53, 132.
Sonic Marker Beacon, 28.
Sonne, 153, 154.
Sphere/-ical Markers, 53, 59, 135, 136.
SSALR, SSALSF, xii, 61.
Standard Beam, 30.

Stop Bar Lights, 15, 52, 101, 109.
Stop Bar Markings, 147.
Stopway Day Markers, 163, 165.
Stopway Edge Markers, 53, 132, 165.
Stopway Lights, 52, 80, 108, 161.
Strip Lights, 32.
Strobe Lights, 23, 37, 46, 63.
Surface Lights, 53.
Systems of Approach Day Markers, 165.

TACAN, 148, 149, 150, 151.
Taxiway Lights, 93, 94, 95, 96, 97.
Taxiway Centerline (Straight, Curved Sections; Intersections) Lights, 10, 12, 51, 109, 145, 161.
Taxiway Centerline Markers, 59, 132.
Taxiway Centerline Markings, 53, 111, 127, 164.
Taxiway Day Markings, 164.
Taxiway Edge Lights, 32, 51, 109, 161.
Taxiway Edge Markers, 81, 82, 132, 165.
Taxiway Edge Marking, 53.
Taxiway Guidance Systems, 161, 162, 164.
Taxiway Holding Markings, 115.
Taxiway Holding Position Lights, 75, 80, 161.
Taxiway Holding Position Markings, 53, 127, 164.
Taxiway Inset (Inpavement) Lights, 51, 62.
Taxiway Intersection Marking, 53, 127, 164.
Taxiway Light/-ing, 12, 16, 20, 32, 42, 49, 55, 62, 68, 69, 75, 80, 92, 101, 102, 104, 105, 106, 111, 161.
Taxiway Longitudinal Markings, 147, 164.
Taxiway Markers, 132, 133.
Taxiway Day Markings, 164.
Taxiway Markings, 53, 163.
Taxiway/Runway Intersection Signs, 123.
Taxiway Side Stripe Lines, 137, 164.
Taxiway Side Stripe Markings, 148.
TDZ Lights, xii, 39, 51, 101, 108, 145, 161.
TDZ Markings, 53.
TDZ Zone Markings, 126, 147, 163.
Three-Bar AVASIS, 61, 160.

Three-Bar VASIS, 51, 66, 94, 95, 144.
Threshold/End Lights, 49, 62, 69, 106.
Threshold Identification Light, 51.
Threshold Lights, 12, 20, 32, 34, 39, 41, 64, 108.
Threshold Markings, 53, 125, 126, 163.
TLLAS, xii.
T-PASI, xii, 37, 61, 66, 68, 98, 100.
Turning Lanes, 115.
T-VASIS, xiii, 51, 54, 67, 81, 93, 94, 95, 96, 97, 100, 160.
TVG, xiii, 67, 68, 93.
TVOR, 151.
Tri-Color Aids, 66, 98, 100.
Tri-Color VASI, 68, 94.
Type I, Type II (Approach), 61.

Unidirectional Flashing Light, 60.
Unidirectional High Intensity Lights, 54.
Unlighted Aids, 14, 48, 122, 159.
Unlighted Navigation Aids, 52, 121.
Unlighted Obstruction Markings, 113.
Unpaved Edge Markers, 53, 72.
Unpaved Runway Edge Markers, 81, 132, 165.
Unpaved Runway Edge Markings, 165.
Unpaved Runway Day Markings, 163.
Unpaved Runway Markings, 163.
Unpaved Taxiway Day Markers, 164.
Unpaved Taxiway Edge Markers, 53, 165.
Unserviceability Cones, 164.
Unserviceability Flags, 164.
Unserviceability Marker Boards, 164.
Unserviceability Markers, 148.
Unserviceability Markings, 164.
Unserviceable Area Aids, 136, 137.

VAPI, xiii, 67.
VASIS, xiii, 51, 55, 66, 68, 81, 94, 97, 99, 100, 160.
VDGS, 110, 145, 162.
Vertiport Lights, 63, 71, 111.

Vertiport Markings, 63, 71, 111.
VGPI, 68, xiii.
VHF Multi-Track Pulse Range, 158, 167.
VHF Multi-Track Range, 149.
Visual Aids, vii, viii, 5, 9, 16, 20, 28, 42,
47, 146, 159, 160, 162.
Visual Aids for Denoting Obstacles, 134.
Visual Aids for Denoting Restricted Use Areas,
136, 164.
Visual Aids for Navigation, 1, 159.
Visual Docking Guidance System, 52, 110, 111.
Visual Navigation Aids, 2.
Visual Parking & Docking Guidance, 109.
VOR, 30, 35, 41, 53, 82, 141, 142, 148, 149,
150, 166.
VOR Aerodrome Check Point Markers, 81, 125,
165.
VOR Aerodrome Check Point Markings, 124, 127,
148, 163.
VOR Aerodrome Check Point Signs, 81, 124, 165.
VOR/DME, 139, 141, 150, 154.
VORTAC, 148, 150, 151.

Water Aerodrome Aids to Taxying, 164.
Water Aerodrome Day Markings, 163.
Water Aerodrome Day Marking Landing Aids, 163.
Winching Area Markings, 53.
Wind Cones, 26, 81, 82, 111, 129, 130.
Wind Direction Indicators, 129, 162.
Wind Indicators, 26, 52, 57.
Wind Socks, 129.
Wind Tee, 26, 34, 82, 129, 130.
Wireless Lighthouse 29.

Xenon Discharge Light, 83.

Z Markers, 153.

INDEX OF NAMES:

GEOGRAPHICAL, POLITICAL, PERSONAL, CORPORATE,
ORGANIZATIONS, & GOVERNMENT AGENCIES

ADB, ix, 2, 54, 76, 79, 80, 81, 82, 88, 89, 104,
106, 113, 115, 130, 132, 133.
Adock, 31.
Aeronautical Board, 40.
Aeronautical Research Labs, x.
Africa, 7, 8.
AGA, 25, 40.
Air Afrique, 8.
Air Flo, xi.
Air France, 18.
Air University Library, ix.
Alaska, 34.
ALPA, 38, 39, 40, 41.
Ameriel, ix.
Antonienka, 34, 92.
Arcata, 38, 39.
Argentina, 8.
Army/Air Force/Navy/Civil Landing Aids
Experiment Station, 33, 40.
Ashford and Wright, 71, 111.
Atlantic, 17.
ATA, 40, 45.
Australia, x, 7, 8, 18, 19, 25, 32, 35, 67,
93.
Aviation Committee, 42.
Bahrein, 8.
Barthes, 10.
Bartow, 34, 40.
Belgium, x, 7, 19, 151.
Bellini-Tosci, 30.
Benin, 8.
Black, 20, 23, 25, 26.
Blacklock, 155, 156.

Boughton, 25.
Brazil, 7, 8.
Breckinridge, 24, 34, 35, 41, 91.
British Empire & Commonwealth, 19.
Buck, 1.
Burkina-Faso, 8.
Buttersworth-Hayes, 142, 146.
CAA, U.S., x, 34, 39, 40, 41, 45, 46, 47,
114.
CAB, U.S., x, 6, 40.
Caldwell, 25.
California, 18, 46.
Calvert, 39, 44.
Canada, x, 7, 8, 19, 142, 152, 155.
Cegelec, ix, 2, 20, 67, 70, 80, 81, 98, 104,
105, 114.
Central Africa, 19.
Central African Republic, 8.
Chad, 8.
Cheyenne, 18.
Chicago, 18.
Chicago-New York, 29.
China, 7, 8.
Christian, 47.
Clark, x, 34, 92, 93, 94.
Clausing, 148, 149, 152, 155.
Colombia, 8.
Condom, Pierre, 59.
Congo, 8, 19.
Cook, 66.
Crouse-Hinds, ix, 2, 67, 78, 79, 105,
106, 114, 116, 130.
Danaid, ix, 62, 67, 81, 98, 99, 100,
129.
Davies, 19.
Denmark, x, 7, 151.
Devore, ix, 55, 67, 98, 100.
Dijon, 25.
Douglas, 16, 33.
Duke, 20, 21, 26.

Dutch East Indies, 17, 18.
East Asia, 19.
EG&G, ix, 80,, 81, 117, 118.
Elfaka, 47.
ESNA, ix.
Ethiopia, 8.
Eurocontrol, x.
Europe (-an), 4, 18, 19, 24, 25, 26, 27, 30,
116, 153.
Europe ICAO, 42, 43.
FAA, x, i, 2, 5, 24, 48, 49, 55, 68, 69, 70, 79,
82, 85, 87, 88, 89, 91, 107, 108, 112, 114,
130, 132, 136, 151, 152.
FANS, 129, 130.
Field, 2.
Finch, 18, 19, 20.
Follett, 19.
France, x, 7, 8, 45, 151.
French Indo-China, 19.
French Polynesia, 8.
Fresnel, 4, 70, 116, 117.
General Electric, ix, 28, 47.
Germany, x, 7, 8, 30, 153.
Gibbs-Smith, 17.
Givon, 11.
Glidden, 34.
Glines, 142.
Godfrey Engineering, ix, 80, 89, 106.
Goldstrom, 25.
Gordon, 34, 92, 93, 94.
GP&S Systems, 155.
Greece, 8.
Greif, 27.
Grover, 30, 148, 153, 157, 158.
Gulf States, 7.
Hall, 1, 30.
Harper, 18, 22, 25.
Harvey, 27.
History of Air Navigation Group, 16.
Hobbs, 141, 156.

Hounslow, 26.
Hudson, 42.
Hughey & Philips, ix.
Humboldt County Library, ix.
IATA, 39, 141.
Idelwild Airport, 46.
Idman, ix, 2, 54, 78, 79, 81, 105.
Illuminating Engineering Society, x,
47, 48.
Imperial Airways, 18.
India, 7, 8, 18.
Indianapolis, 34, 38.
Indonesia, 7, 8.
Inter-Allied Aviation Commission, 42.
International Air Convention, 42.
International Civil Aviation Organization
(ICAO), ix, 1, 3, 4, 5, 6, 7, 9, 17, 37, 43,
44, 45, 46, 49, 54, 56, 57, 59, 60, 63, 64, 65,
66, 67, 68, 69, 79, 82, 89, 91, 94, 96, 98, 99,
100, 102, 104, 105, 107, 108, 109, 110, 112,
113, 114, 115, 119, 121, 123, 124, 125, 126,
129, 132, 133, 134, 136, 137, 140, 141, 142,
143, 147, 148, 151, 153, 154, 157, 158, 159.
International Commission for Air Navigation
(ICAN), 42, 43.
International Hydrographic Bureau (IHB), 154,
157.
International Telephone Development Co., 36.
Israel, 7.
Italy, 7, 8.
ITT Avionics, xi.
ITTE, 57.
Ivory Coast, 8.
Jaquith Industries, xi.
Japan, 7, 8.
Kayton, 30, 36.
Kendall, 29, 30, 31, 35, 36.
KLM, 17.
Knoxville, 46.
Komons, 23, 29.

Kroger, 34, 38, 41.
Lans, Hoken, 155.
Laughton, 116.
Library of Congress, ix.
Lindsey, 87.
Line Material, 40, 41.
Lockheed Electric, 47.
Lorenz Co., 29.
Luxembourg, ix.
McGhee-Tyson AFB, 46.
McKinleyville, CA., 39.
Madagascar, 8.
Malaysia, 7, 8.
Mannairco, ix.
March AFB, 43, 46, 47.
Mauritania, 8.
Mexico, x, 7, 8.
Ministry of Defense (MOD), U.K, x.
Moore, 38.
Morse, 24, 30, 118, 143, 144, 145, 149,
152, 153.
Mount Angel Abbey Library, ix.
Mueller, 16.
Multi-Electric, ix, 81, 89, 99, 117.
Nantucket, 33.
National Archives, x.
NATO, ix, xi, 2, 49, 57, 60, 61, 63, 64,
65, 68, 80, 87, 112, 151.
Nautel, ix.
NBS, 16, 33.
Netherlands, The, 7, 47.
New Zealand, 8.
New York, 18.
Niger, 8.
North America, 27, 116.
North Atlantic, 19, 156.
North Carolina, 17.
Norvell, ix, 7, 8, 151.
Norway, x, 7, 8, 151.
O'Dea, 22, 26.

Ohio, 18.
Olsen, 139, 140, 141, 142, 146, 150, 155.
Oman, 7.
Omnipol/Tesla, ix, 104.
Oregon State University Library, ix.
Pacific, 19.
Page, David, x, 16.
Pakistan, 7.
Papua New Guinea, 8.
Paris, 42.
Paris-Algiers, 25.
Paris Peace Conference, 42.
Parnell, 28, 35.
Patuxent Naval Air Station, 45.
Philippines, 7, 8.
Philips, 106.
Pollock, 57, 106, 133.
Portland State University Library, ix.
Provisional ICAO (PICAO), xi, 17, 43, 44.
Qatar, 7.
RAE, 2, 44.
Robson, 47.
Royal Air Force, 34.
Royal Institute of Navigatin, x, 16.
Russia, 67, 141, 154.
Russian Federation, 7.
SAS, 7.
St. Exupery, 18.
St John Spriggs, 20, 22.
Saudia Arabia, 7.
Scandinavia, 7.
Scheller, 29.
Senegal, 8.
Sessions, 16.
Siemens, ix.
Singapore, x, 7.
Slo-Idman, 50.
Smith, H.L., 43.
South Africa, 8, 19.
South America, 18, 19.

South Korea, 7.
Soviet Union, 7.
Spain, 7, 8.
Sweden, 7, 8, 133.
Switzerland, x, 7, 151.
Sylvania, 40, 47.
Taiwan, x, 151.
Taneja, 17.
Telefunken, 28.
Tesla, 80.
Thailand, 7.
Thorn Europhane, ix, 54, 78, 80, 97, 105,
113, 114, 129.
Togo, 8.
Toshiba, ix, 116.
Tull Aviation, ix, 83.
Turner, 145, 146.
TWR, ix.
Ulmer Aeronautique, ix, 57.
Underwood, 154.
United Arab Emirates, 7.
United Kingdom, x, 7, 8, 30, 37, 39, 43, 44,
45, 47.
United Nations, 4, 5.
Unitron International Systems, xi.
University of California, Berkeley, Libraries,
ix.
University of California, Davis, Libraries, ix.
University of Oregon Libraries, ix.
U.S., x, 2, 4, 5, 7, 8, 11, 18, 19, 20, 24, 25,
26, 29, 30, 31, 33, 35, 37, 38, 41, 44, 45, 46,
47, 55, 56, 57, 61, 63, 64, 65, 66, 68, 69, 78,
79, 87, 88, 89, 91, 94, 114, 115, 132, 142,
143, 145, 148, 150, 151, 154, 157.
U.S. Air Force, 40, 45, 46, 47.
U.S. Army, 18, 29.
U.S. Commerce Dept., 20.
USDOD, x, 155.
USDOT, x, 155.
U.S. Lighthouse Bureau, Airways Division, 24.

U.S. Navy, 2, 33, 40, 45.
U.S. Post Office, 18, 29.
USSR, 8.
Valerian, 25.
Valley Illuminators, xi.
Venezuela, 8.
Warner, 17, 18.
Westinghouse Electric, ix, 26, 39, 80.
Whitnah, 21.
Wilcox, ix, 1, 156.
Wilson, 31, 36, 38, 41.
Wood, 20, 21, 34.
World War I, 17, 30.
World War II, 19, 27, 36.
Yaounde Treaty States, 8.
Young, 27.

COLOPHON

This book was prepared on an Apple III computer using Three Easy Pieces software. Drafts and other materials were printed on an Apple daisy wheel printer with Prestige Elite 12 type.

Manuscript preparation was augmented by an IBM Selectric II typewriter with Courier 10 type.

The "printing masters" were prepared on an Apple Laserwriter II printer with Courier 12 type. This required the assistance of a MacIntosh LC computer which incorporated the "brains" of an Apple IIe computer and an updated version of Appleworks software (which is closely related to Three Easy Pieces). Br Justin Hertz, computer director for Mount Angel Seminary, and an Appletalk network completed the preparations. Portions of the printing masters were composed on the aforementioned IBM Selectric II typewriter.

The pages were printed on a Canon NP 6650 copier augmented by a Canon NP 4050 copier.

The cover was printed on Cross Pointe 80 pound stock with felt finish and in the hue known as pumice. The book was printed on Cross Pointe 60 pound Bellbrook Laid Text in Oxford cream.

Covers were typeset and printed by the Benedictine Press. The monograph was bound at Your Town Press in Salem.