

DEFINING THE MOLECULAR MECHANISMS THAT GOVERN PAR-3 MEDIATED
POLARIZATION OF THE PAR-COMPLEX

by

RYAN WAKEFIELD HOLLY

A DISSERTATION

Presented to the Department of Chemistry and Biochemistry
And the Graduate School of the University of Oregon
In partial fulfillment of the requirements
For the degree of
Doctor of Philosophy

March 2020

DISSERTATION APPROVAL PAGE

Student: Ryan Wakefield Holly

Title: Defining the Molecular Mechanisms that Govern Par-3 Mediated Polarization of the Par-Complex

This dissertation has been accepted and approved in partial fulfillment of the requirements for the Doctor of Philosophy degree in the Department of Chemistry and Biochemistry by:

Brad Nolen	Chairperson
Kenneth Prehoda	Advisor
Tom Stevens	Core Member
Mike Harms	Core Member
Scott Hansen	Core Member
Chris Doe	Institutional Representative

and

Kate Mondloch	Interim Vice Provost and Dean of the Graduate School
---------------	------------------------------------------------------

Original approval signatures are on file with the University of Oregon Graduate School.

Degree awarded March 2020

© 2020 Ryan Wakefield Holly

DISSERTATION ABSTRACT

Ryan Wakefield Holly

Doctor of Philosophy

Department of Chemistry and Biochemistry

March 2020

Title: Defining the Molecular Mechanisms that Govern Par-3 Mediated Polarization of the Par-Complex

Animal cells polarize their membranes into discrete functional domains required for a host of cellular processes including asymmetric cell division, epithelial morphogenesis, neuronal polarization, and cell migration. A key regulator of animal cell polarity is the protein kinase, atypical Protein Kinase C (aPKC), whose activity is required for establishing and maintaining membrane polarity. While much is known about how the activity of aPKC polarizes cells, understanding the molecular mechanisms that lead to the regulation and localization of aPKC itself have remained controversial. aPKC's apical localization depends on three additional proteins: Par-6, Par-3, and Cdc42. The focus of this work has been to understand the interplay between these proteins that lead to polarized aPKC.

Par-3 is a regulatory substrate thought to directly target aPKC to the membrane. The first part of this work argues against a previously held view that Par-3 is an inhibitor of aPKC that is not phosphorylated until additional factors activate aPKC kinase activity. I clearly demonstrate that aPKC can indeed phosphorylate Par-3 without any additional

inputs and that catalytic efficiency is similar to other known aPKC substrates.

Furthermore, I argue that while Par-3 can indeed inhibit aPKC kinase activity, all substrates tested can inhibit kinase activity, questioning the physiological consequences of Par-3 inhibition of aPKC.

The second part of this work aims to understand the physical interactions between Par-3 and the Par-complex, and how these interactions might contribute to the regulation of aPKC. At least 5 different interactions have been proposed between Par-3 and the Par-complex. Surprisingly, in vitro domain deletion analysis revealed that none of the previously proposed interactions are required for binding to the fully reconstituted Par-complex. However, through this analysis, I uncovered a novel interaction between the PDZ2 domain of Par-3 and a conserved aPKC PDZ ligand binding motif (PBM) that is required for the apical polarization of aPKC in the *Drosophila* neuroblast. Overall, the work presented in this dissertation significantly clarifies the controversial mechanisms surrounding the interactions between Par-3 and the Par-complex while defining a novel physical connection that links Par-3 to the Par-complex.

This dissertation includes previously published co-authored material.

CURRICULUM VITAE

NAME OF AUTHOR: Ryan Wakefield Holly

GRADUATE AND UNDERGRADUATE SCHOOLS ATTENDED:

University of Oregon, Eugene
Portland State University, Portland
University of Nebraska, Lincoln

DEGREES AWARDED:

Doctor of Philosophy, Chemistry and Biochemistry, 2020, University of Oregon
Master of Science, Organic Chemistry, 2007, University of Oregon
Bachelor of Arts and Sciences, 2005, University of Oregon

AREAS OF SPECIAL INTEREST:

Biochemistry
Enzymology
Molecular Biology
Cell Biology

PROFESSIONAL EXPERIENCE:

Graduate Research Fellow, Department of Chemistry and Biochemistry.
University of Oregon, Eugene, 2015-2020

Graduate Teaching Fellow, Department of Chemistry and Biochemistry.
University of Oregon, Eugene, 2015-2015

Lead Scientist, Nanovalent Pharmaceuticals.
Bozeman, Montana, 2013 – 2015

Research Associate, ATERIS Technologies
Bozeman, Montana, 2007 - 2013

GRANTS, AWARDS, AND HONORS:

National Institute of Health (NIH) Molecular Biology and Biophysics Training Grant (MBBTG). University of Oregon, 2015-2018

PUBLICATIONS:

Holly, R.W., Prehoda, K.E. (2019) Phosphorylation of Par-3 by Atypical Protein Kinase C and Competition Between Its Substrates. *Dev. Cell* 49, 678-679.

Holly, R.W., Jones, K., Prehoda, K.E. (2020) A Conserved aPKC PDZ Binding Motif That Interacts With Par-3 and Mediates Cortical Polarity. *Current Biology*. 30 (5), 893-898.

ACKNOWLEDGMENTS

First and foremost, I would like to acknowledge Dr. Ken Prehoda for his mentorship and guidance that has been invaluable to my successes as a graduate student. Ken has always challenged me to think critically and ask the difficult questions. To my committee members, Dr. Brad Nolen, Dr. Mike Harms, Dr. Scott Hansen, Dr. Tom Stevens, and Dr. Chris Doe for your continued support and advice. To my lab mates, past and present especially Dr. Oggie Golub and Dr. Mathew Bailey whose senior advice and experience was helpful in navigating the ups and downs of graduate school. To the IMB community and especially Connor Balzar and Dr. Byron Hedrick for all the lively lunch discussions. To Jane and Keith for their continued support throughout this process. Date nights couldn't have happened with such frequency without you. To my parents, Norm and Beth, for not giving up on me through my more difficult early years. Your unconditional love and support throughout those years is one of the only reasons I am here today. And finally, to my wife Sarah, daughter Maya, and son Mason, none of this could have been accomplished without your love and understanding. Sarah, you have kept me sane through this adventure and you kept me grounded and supported me through the more challenging times. Maya and Mason, you two rock!! The ease at which you navigate life and the love that you share gave me the inspiration to keep chugging along.

To my wife Sarah, daughter Maya, and son Mason to whom none of this would be possible without their love and support.

TABLE OF CONTENTS

Chapter	Page
I. REGULATION AND LOCALIZATION OF THE PAR-COMPLEX IN ANIMAL CELL POLARITY	1
Introduction.....	1
aPKC and the apical polarity network	6
Protein Kinases: Regulators of cellular processes	6
Multimodal activation of aPKC allows for precise spatial and temporal activation.....	8
The Par-complex and the role of Par-6 and Cdc42 in regulating aPKC activity and localization	10
The role of Par-3 in regulating aPKC activity and localization.....	13
Localization of Par-3 is dynamic	14
The Par-3 aPKC phosphorylation motif recruits aPKC through a stable and inhibited complex.....	15
Binding interaction between the Par-complex and the Par-3 PDZ domains ..	17
Knowledge Gap: The complex and controversial nature of Par-3's interaction with the Par-complex	19
Bridge to Chapter II	22
II. PHOSPHORYLATION OF PAR-3 BY ATYPICAL PROTEIN KINASE C AND COMPETITION BETWEEN ITS SUBSTRATES	23
Methods.....	29
Expression and Purification of aPKC Kinase Domain	29

Chapter	Page
Expression and Purification of Substrates	30
Competition Assays	32
Kinetic Simulations.....	32
Acknowledgements.....	33
Bridge to Chapter III.....	33
III. A CONSERVED aPKC PDZ BINDING MOTIF INTERACTS WITH PAR-3 AND MEDIATES CORTICAL POLARITY	35
Summary	35
Results and Discussion	36
Par Complex Phosphorylation of Par-3	36
Par-3 PDZ2 is Required for Interaction with the Par Complex	39
A Conserved aPKC PDZ Binding Motif is Required for Interaction with Par-3	40
The Role of Par-3 Phosphorylation in its Interaction with the Par Complex	42
The aPKC PDZ Binding Motif is Required for Neuroblast Polarization	44
Star Methods	47
Experimental Model and Subject Details	47
Animals: Drosophila	47
Method Details.....	48
Expression and Purification of Par-complex	48

Chapter	Page
Expression and Purification of Par-3	49
Affinity Chromatography Interaction Assay	50
Supernatant Depletion Interaction Assay.....	51
Drosophila Neuroblast Immunofluorescence	52
Drosophila Neuroblast MARCM clones.....	53
Quantification and Statistical Analysis.....	53
Quantification of Equilibrium Dissociation Constants	53
Drosophila Neuroblast Quantification	54
Bridge to Chapter IV.....	55
IV. FUTURE PERPECTIVES AND CONCLUDING REMARKS	56
Summary.....	56
Future Considerations	57
The role of Par-3 as a regulator of aPKC activity.....	58
Cdc42 dissociates Par-3 from the Par-complex	59
The role of Par-3 phosphorylation in animal cell polarity	62
Concluding Remarks.....	64
APPENDICES.....	65
A. SUPPLEMENTAL MATERIALS FOR CHAPTER III.....	65
REFERENCES CITED.....	67

LIST OF FIGURES

Figure	Page
1. Animal cell polarity is found in diverse cell types	2
2. Asymmetric cell division in neural stem cells	3
3. Phosphorylation mediated cortical displacement.....	4
4. Localization of aPKC throughout the <i>D. Melanogaster</i> neuroblast cell cycle	5
5. Crystal structure of aPKC ϵ in complex with Par-3 peptide.....	7
6. PKC's vary in their NH ₂ -terminal regulatory domains.....	9
7. Domain architecture of aPKC and Par-6	10
8. Par-3 interacts with aPKC and Par-6	13
9. Phosphorylation of Par-3 and other substrates by atypical Protein Kinase C and competition between its substrates.....	26
10. Par-6/aPKC binds and phosphorylates Par-3	37
11. Par-3 PDZ2 is required for Par complex binding	39
12. A conserved aPKC PDZ Binding Motif required for Par-3's interaction with the Par complex	41
13. aPKC polarization requires its PDZ Binding Motif.....	45
14. Par mediated animal cell polarization.....	57
15. Cdc42 inhibits the interaction between the Par-complex and the Par-3 PDZ2.....	61

CHAPTER I
REGULATION AND LOCALIZATION OF THE PAR-COMPLEX IN ANIMAL
CELL POLARITY

Chapter II contains previously published co-authored material

Chapter III contains previously published co-authored material

INTRODUCTION

The segregation of cellular components such as proteins, lipids, organelles, and small molecules into discrete regions of the cell is important for diverse cellular processes such as, epithelial morphogenesis, asymmetric cell division (ACD), embryogenesis, neuronal signaling, and cell migration (Figure 1) (Goldstein and Macara, 2007). This process, known as animal cell polarity, is used to create cellular diversity, tissue organization, and to provide domain specific functions required of specialized cells (Apodaca and Gallo, 2013). Epithelia are a great example of a polarized cell whose function is to form sheets of adherent cells, lining organs with a protective barrier against the external environment. Proper segregation of the epithelial membrane into distinct apical, basal-lateral, and junctional domains is required for development, and loss of this polarity leads to gross morphological defects in the organism (Harris and Peifer, 2005; Hutterer et al., 2003; Tepass et al., 2001; Wodarz et al., 2000; Yamanaka et al., 2001).

Another example of a polarized cell is the *Drosophila melanogaster* neuroblast (neural stem cells), which segregate specific sets of proteins known as fate determinants into opposite poles of the cell (Figure 2). Throughout the process of asymmetric cell

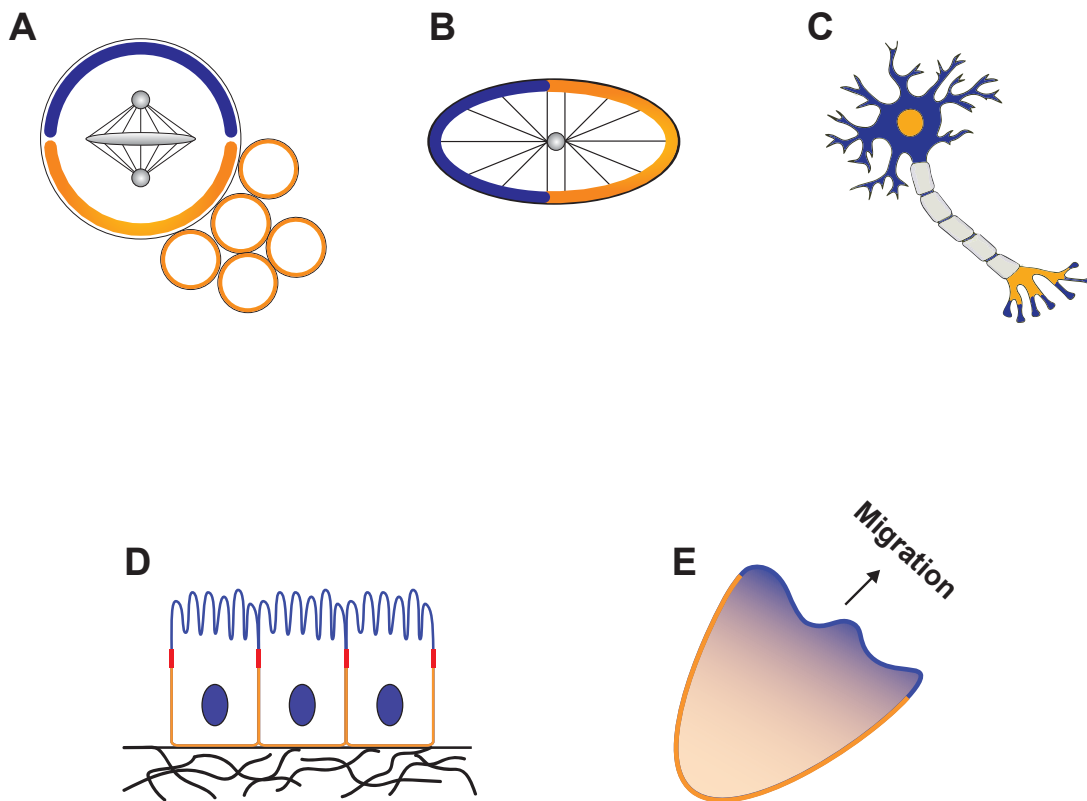

Figure 1: Animal cell polarity is found in diverse cell types. Animal cells polarize their membranes into discrete apical (purple) and basal/basal lateral (orange) domains for a variety of specialized functions. (A) Neural stem cell (neuroblast) with budding GMC's. (B) *C. elegans* zygote at the single cell stage. (C) Neuron. (D) Epithelial cell with junctions (red). (E) Migratory Cell.

division (ACD), each post-mitotic daughter cell will contain a unique set of fate determinants necessary to generate two different daughter cells varying in their fate. One daughter will become an exact replicate of the original neuroblast while the other daughter will give rise to a ganglion mother cell (GMC) that undergoes one more round of division, populating the central nervous system with neurons and glia (Prehoda, 2009). A similar process of asymmetric cell division is found in the *C. elegans* zygote where sperm derived cues induce the segregation of fate determinants required to specify cell type (Kemphues et al., 1988).

Remarkably, while the functional output of animal cell polarity varies considerably between polarized cells, the mechanisms that underly the establishment and maintenance of cell polarity are highly conserved. In general, regulators of cell polarity are restricted to their respective apical and basal cortical domains, where they exert their activity to establish polarity gradients through mutual antagonism (Prehoda, 2009; Tepass, 2012). A key regulator of cell polarity is the protein kinase, atypical Protein Kinase C (aPKC). Many polarized metazoan cells utilize the activity of aPKC to establish and maintain a strict apical-basal cortical gradient.

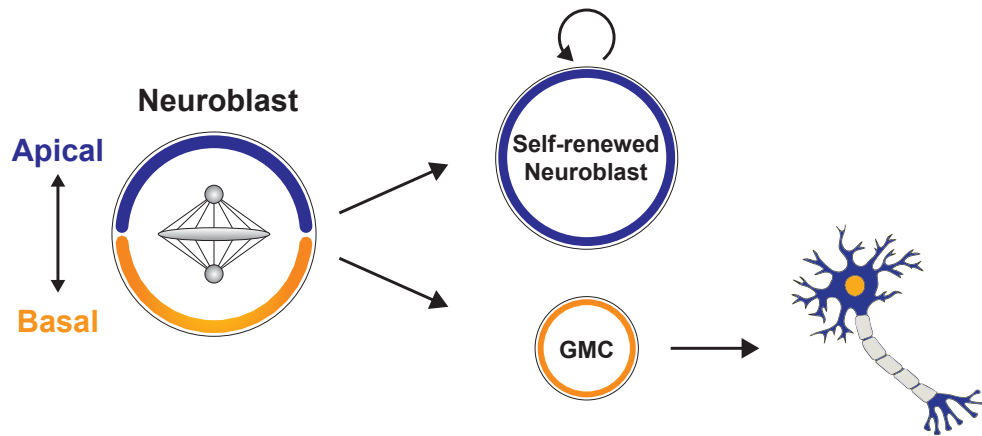

Figure 2: Asymmetric cell division in neural stem cells. Neural stem cells (neuroblasts) divide asymmetrically giving rise to two molecularly distinct daughter cells. One daughter will self-renew becoming an exact replica of the original neuroblast while the other will become a ganglion mother cell (GMS) undergoing one more round of division populating the central nervous system with Neurons and glia.

In neuroblasts, the activity of aPKC is required to set up an apical/basal gradient where aPKC is retained at the apical cortex, restricting fate determinants like Miranda (Mira) and Numb to the basal cortex through phosphorylation mediated cortical displacement (Figure 3) (Atwood and Prehoda, 2009; Betschinger et al., 2003; Hurov et al., 2004; Smith et al., 2007; Wirtz-Peitz et al., 2008). During interphase of the mitotic

cell cycle, Mira and Numb can freely diffuse throughout the cortex while aPKC is inactive and cytoplasmic (Figure 4). As the cell moves into prophase, aPKC begins to form discrete puncta that grow in size, eventually coalescing at metaphase into one homogeneous patch to form an apical cap (Oon and Prehoda, 2019). Polarized aPKC uses its activity to phosphorylate the fate determinants Numb and Mira at multiple basic and hydrophobic motifs that inhibit their association with the negatively charged lipid environment of the cell cortex, restricting their localization to the basal cortical domain (Bailey and Prehoda, 2015). aPKC's activity remains polarized throughout metaphase and depolarizes during telophase, at which point aPKC is lost to the cytoplasm and the cycle repeats (Oon and Prehoda, 2019).

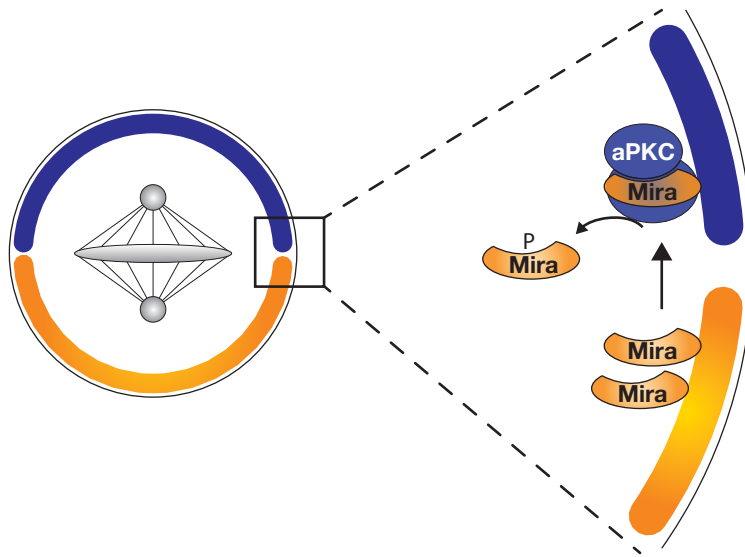

Figure 3: Phosphorylation mediated cortical displacement. aPKC phosphorylation of fate determinants like Miranda (Mira) inhibits their interaction with the cell cortex, restricting them to the basal domain.

The diversity of polarized cells that require aPKC to establish polarity gradients is remarkable. Common to all aPKC polarized cells is the need to regulate the spatial and temporal activity of aPKC such that it is only active when localized to the apical cortical domain. The regulation of aPKC depends on both intra-molecular interactions with its NH₂-terminal regulatory domains as well as interactions with Par-6, Cdc42, and Par-3 (Etienne-Manneville and Hall, 2002; Graybill et al., 2012; Horikoshi et al., 2009; Nagai-Tamai et al., 2002; Suzuki, 2006; Yamanaka et al., 2001; Zhang et al., 2014). Together with aPKC these four proteins form the basis of the apical polarity network and are required for the proper establishment and maintenance of animal cell polarity.

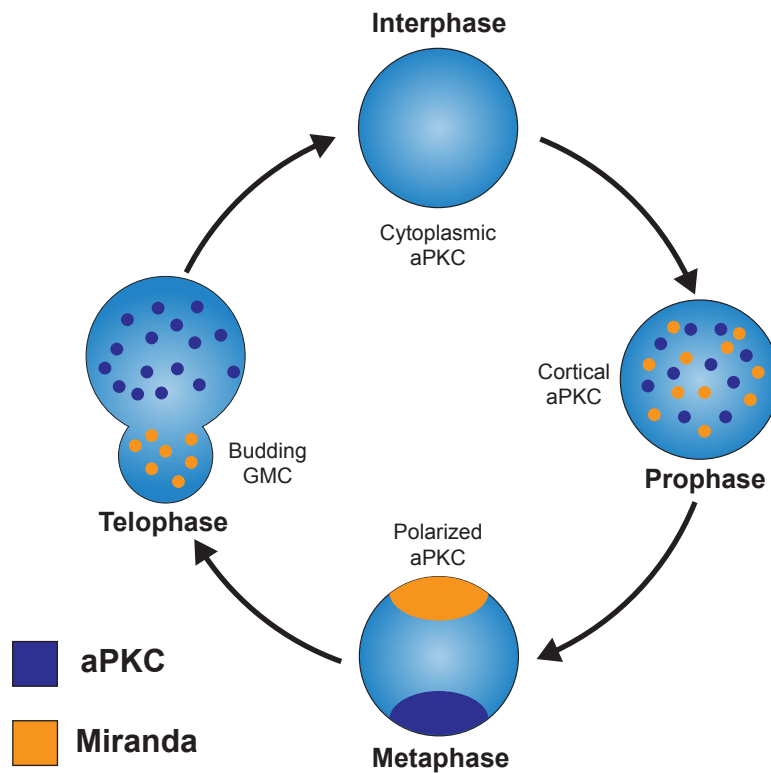

Figure 4: Localization of aPKC and Miranda throughout the *D. Melanogaster* neuroblast cell cycle. At interphase aPKC starts out cytoplasmic, moving to the entire cortex in prophase. By metaphase, aPKC is polarized to the apical cap. By telophase, aPKC is absent from budding GMC. Following cleavage, aPKC dissociates from the membrane into the cytoplasm where the cycle repeats.

aPKC and the apical polarity network

aPKC is a potent serine/threonine kinase whose activity must be tightly regulated. Removing any component of its regulation has dramatic effects on cell polarity. For example, in the *Drosophila* neuroblast, depolarization of aPKC activity through a mutation that drives it to the entire cortex throughout the cell cycle, gives rise to symmetrically dividing neuroblasts (Wirtz-Peitz et al., 2008). Bypassing the regulation of aPKC activity and localization allows aPKC to inhibit all cortical Mira leading to over proliferation of neuroblasts and tumor formation in the central brain. While the catalytic activity of aPKC is responsible for phosphorylation of substrates, its activation and localization are regulated by its NH₂-terminal regulatory domains and interactions with several important Par-polarity proteins: Par-6, Cdc42, and Par-3. In the following sections I will give a general overview of protein kinases, discuss the importance of the aPKC NH₂-terminal regulatory domains, and the reported mechanisms of aPKC regulation by Par-6 and Cdc42.

Protein Kinases: Regulators of cellular processes

Protein phosphorylation by kinases is an essential process necessary for proper cellular signaling events such as activation or inhibition of enzymes and proper localization of targeted substrates (Endicott et al., 2012). Currently there are over 500 kinases that make up the human kinome representing nearly 2% of the human genome (Taylor and Kornev, 2011). Kinases can be loosely divided into two broad categories, those that phosphorylate serine or threonine residues and those that phosphorylate

tyrosine. Both Ser/Thr and Tyr kinases share similar sequence homology within the ~290 amino acid catalytic core that makes up the kinase domain.

Catalytically active kinases share similar structural features, however, in their inactive form structure diverges significantly (Endicott et al., 2012; Jura et al., 2011; Noble et al., 2004). The active conformation of kinases requires the proper alignment of the N and C lobes as well as the regulatory and catalytic spines in order to allow for both ATP binding and to form the catalytically competent active site for proper phosphorylation of substrates (Figure 5). Additionally, the active conformation of

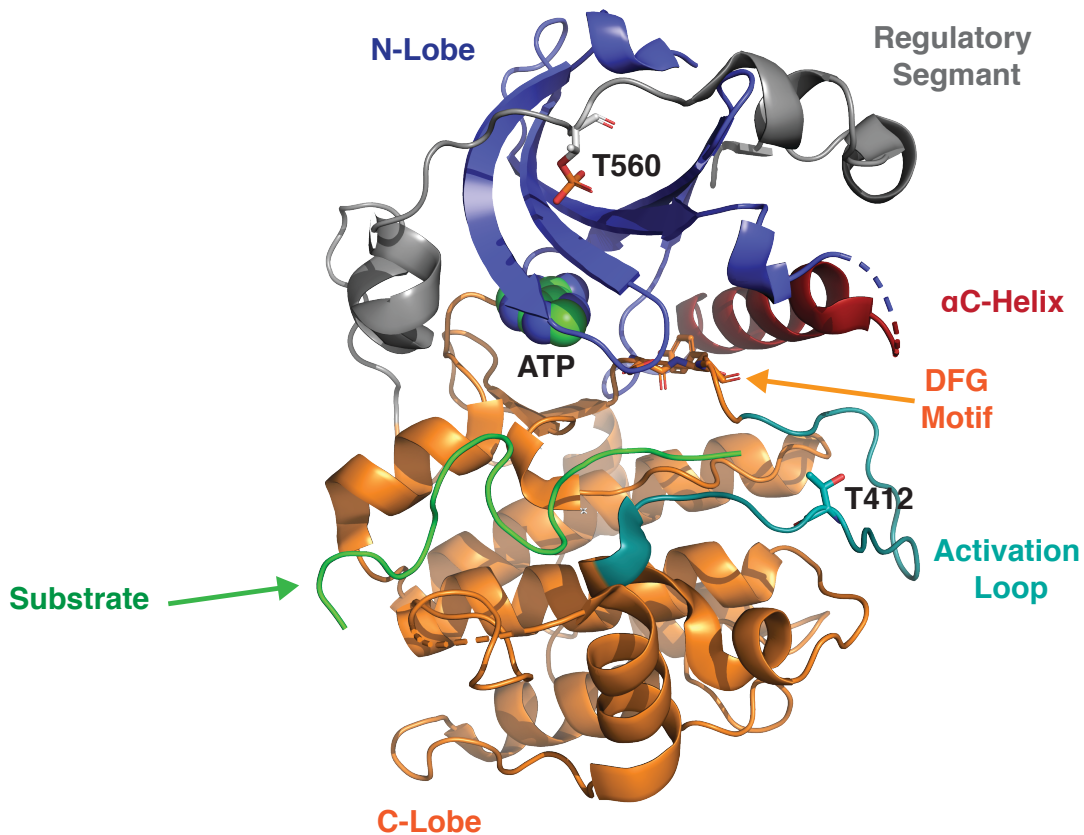

Figure 5: Crystal structure of aPKCι in complex with Par-3 peptide. Crystal structure of aPKCι highlighting important structural features. N-lobe (purple), C-lobe (orange), Regulatory segment (gray), αC-Helix (Red), Activation Loop (Teal), Substrate (Green). PDB:4DC2.

kinases requires the presence of Mg^{2+} ions that are chelated through the highly conserved DFG motif that allows for ATP binding necessary for transfer of the gamma phosphate to the substrate. In the inactive conformation, the aspartic acid residue from the DFG motif is positioned into the ATP binding pocket inhibiting the ability of ATP to bind. While the active forms of kinases are structurally and functionally similar, how kinases transition from an inactive to active conformation is highly variable. Molecular mechanisms for such activation include phosphorylation, active site substrate specificity, transcriptional regulatory control, dimerization, substrate availability, and autoinhibition through intramolecular interactions from flanking regulatory domains (Bayliss et al., 2015; Endicott et al., 2012; Nolen et al., 2004). Additionally, kinases can be regulated through repression of auto-inhibitory segments by intermolecular interactions with activator proteins or small molecules (Graybill et al., 2012; Orr et al., 1992). How kinases undergo such regulation and specificity leading to spatial and temporal activation/inactivation has become increasingly important in understanding biological processes. Additionally, due to their significant role in signal transduction pathways, kinases have become desirable drug targets for a multitude of disease states.

Multimodal activation of aPKC allows for precise spatial and temporal activation

The Protein Kinase C (PKC) family of kinases includes 12 homologues which are identified as conventional (cPKC), novel (nPKC), or atypical (aPKC) based on their flanking regulatory domains (Pearce et al., 2010). There are a number of important features that differentiate aPKC from cPKCs and nPKCs, most notably the NH_2 -terminal regulatory domains (Figure 6).

A considerable amount of effort has been put into understanding the mechanism of activation for conventional PKCs especially with respect to the maturation of the catalytic core (Bayliss et al., 2015; Dutil and Newton, 2000; Gao and Newton, 2006; Tepass, 2012; Yamanaka et al., 2001) PKCs initially undergo post-translational phosphorylation of 2 (aPKC) or 3 (cPKC, nPKC) residues within the kinase domain, (Dutil and Newton, 2000) which allows for the proper alignment of the N- and C- lobes as well as the regulatory and catalytic spines, leading to a catalytically competent kinase domain. However, following phosphorylation PKCs become inactivated through the interactions with their NH₂-terminal regulatory domains. This unique multimodal activation of PKCs allows them to be ubiquitously expressed and catalytically competent and inactive such that their activity can be further regulated by cell specific mechanisms. Unlike cPKC's and nPKC's whose lipid binding and activity is dependent on the binding to diacylglycerols or phorbol esters through their C1 domains, aPKC has an "atypical" C1 domain that does not depend on these small molecules for lipid binding (Colongonzalez and Kazanietz, 2006; Giorgione et al., 2006, 2006). The C1 domain of aPKC will be

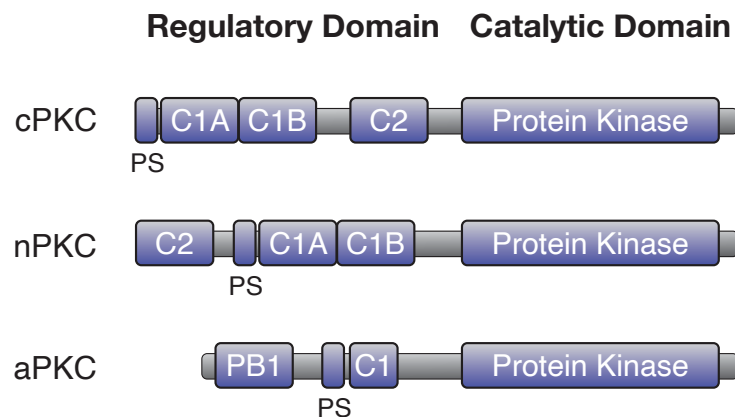

Figure 6: PKC's vary in their NH₂-terminal regulatory domains. Comparison of domain architecture of conventional (cPKC), novel (nPKC) and atypical (aPKC) PKC's.

discussed in more detail below. Additionally, aPKC's are the only PKC family members that contain a PB1 domain, and as will be discussed in the next section, plays a critical role in the apical polarization of aPKC.

The Par-complex and the role of Par-6 and Cdc42 in regulating aPKC activity and localization

The NH₂-terminal regulatory region of aPKC is comprised of several important and highly conserved domains (Figure 7). The Phox/Bem1 (PB1) domain is required for binding to the PB1 domain of the adaptor protein Par-6 through high affinity PB1 heterodimerization and this interaction is required for both localization and activation (Graybill et al., 2012; Hirano et al., 2005). Inhibition of this interaction gives rise to cytoplasmic aPKC that is inactive while Mira is depolarized, localizing to the entire

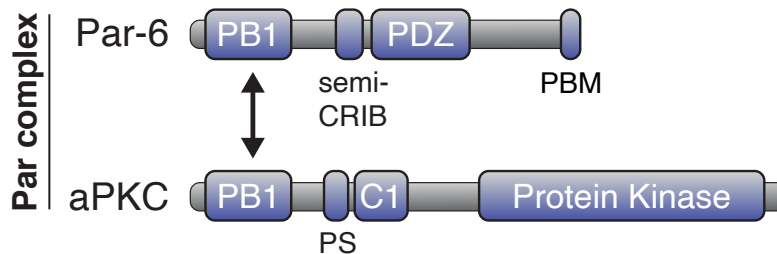

Figure 7: Domain architecture of aPKC and Par-6. Together aPKC and Par-6 form the Par-complex. Abbreviations: PBM – PDZ binding Motif. PS – Pseudosubstrate.

cortex. Together, aPKC and Par-6 form what I will refer to as the Par-complex (Figure 7). COOH-terminal to the aPKC PB1 is a pseudosubstrate (PS) sequence that is similar to aPKC's consensus sequence but lacks a phosphorylatable serine or threonine residue. The PS binds in the catalytic cleft of the kinase domain, acting as a competitive inhibitor giving rise to a catalytically competent, yet inactive aPKC. Par-6 binding represses auto-

inhibition by the PS, thus providing a regulatory mechanism for aPKC's kinase activity (Graybill et al., 2012). Immediately following the PS is a conserved C1 domain that contains a general lipid binding motif. The C1 domain is required for aPKC's association with the cortex and is itself sufficient to bind the cortex, however the C1 alone is not sufficient to drive aPKC to the cortex suggesting some form of regulation of its lipid binding motif. How or if the C1 domain is regulated is still unknown. One hypothesis is that the C1 domain is autoinhibited and due to the close proximity of the PS to the C1, may couple repression of PS autoinhibition to C1 activation leading to an active aPKC while only localized at the lipid membrane. Early studies have shown that phospholipids can in fact activate aPKC, lending further support to this hypothesis (Johnson et al., 2000; Newton, 1997).

As mentioned above, Par-6 contains a PB1 domain that allows for high affinity binding to aPKC through PB1 heterodimerization. COOH-terminal to the PB1, Par-6 contains a semi-CRIB domain directly followed by a PDZ domain (Figure 7). The semi-CRIB is an important feature of Par-6 providing a direct link between aPKC and the membrane tethered small GTPase, Cdc42 (Joberty et al., 2000; Lin et al., 2000). Furthermore, when Par-6 is bound to the active form of Cdc42, it induces a conformational change in the PDZ domain, increasing its affinity for COOH-terminal PDZ ligand Binding Motifs (PBM) by 10 – 20 fold (Peterson et al., 2004; Whitney et al., 2011, 2016). In epithelia, the transmembrane protein Crumbs has a PBM whose binding to the Par-complex is regulated by Cdc42 (Whitney et al., 2016). Interestingly, no PBM's have been identified in neuroblasts that interact with the Par-6 PDZ domain and as such, the role of the Par-6 PDZ domain is largely unknown in this system. However,

as will be discussed later in detail, the PDZ domain of Par-6 has been shown to interact with Par-3 through a non-conventional and controversial mechanism.

Cdc42 is a GTPase whose activity is dependent on its nucleotide state. Cdc42 is conserved throughout eukaryotes from yeast to humans and plays a significant role in numerous cell processes including cytoskeletal dynamics, membrane trafficking, and animal cell polarity (Chant, 1999; Leibfried et al., 2013; Zegers and Friedl, 2014). Guanine Nucleotide Exchange Factors (GEFs) are required to activate Cdc42 by promoting exchange between an inactive GDP bound conformation, and an active GTP bound conformation. GTPase-activating proteins (GAPs) inactivate Cdc42 by promoting the hydrolysis of GTP (Cherfils and Zeghouf, 2013; Ngok et al., 2014). The interplay between GEF's and GAP's is critical for the regulation of Cdc42 activity and it has been shown that their activity is also polarized (Lang and Munro, 2017). Cdc42 is tethered to the cell cortex through a prenylation modification and this in turn allows for the direct tethering of the Par-complex to the cell cortex, mediated by Par-6 (Zhou et al., 2013). While Cdc42 localizes to the entire cortex, its activity is polarized, thus ensuring apical polarization of the Par-complex (Nunes de Almeida et al., 2019; Wang et al., 2017). For example, in WT neuroblasts the Par-complex co-localizes with Cdc42 at the apical domain, however, cells overexpressing a constitutively active form of Cdc42 that drives active Cdc42 to the entire cortex leads to cortical localization of the Par-complex and a depolarized cell. While Par-6 and Cdc42 along with the C1 domain would seem to be sufficient to drive aPKC polarization, the PDZ scaffold protein, Par-3 is also required.

The role of Par-3 in regulating aPKC activity and localization

Par-3 is a large multi-PDZ domain scaffold protein comprised of an NH₂-terminal oligomerization domain that is required for membrane localization, a series of 3 PDZ domains, and an aPKC phosphorylation motif (APM) (Figure 8) (Feng et al., 2007; Li et al., 2010a; Nagai-Tamai et al., 2002; Wu et al., 2007). Par-3 is required for the apical recruitment and retention of aPKC, Par-6, and Cdc42, while its localization, is independent of these other proteins, establishing Par-3 as the most upstream component of the apical polarity network (Atwood et al., 2007; Morais-de-Sá et al., 2010). Par-3 was originally discovered in a landmark genetic screen for mutants that gave rise to partitioning defects in the *C. elegans* embryo (Kemphues et al., 1988). Nearly a decade later, Par-3 was first characterized when it was found to interact with aPKC's catalytic domain through a highly conserved region in the COOH-tail, and this interaction was shown to be required for polarity in both epithelia and the *C. elegans* zygote (Izumi et al., 1998; Tabuse et al., 1998). Since that time no less than 5 distinct interactions have been

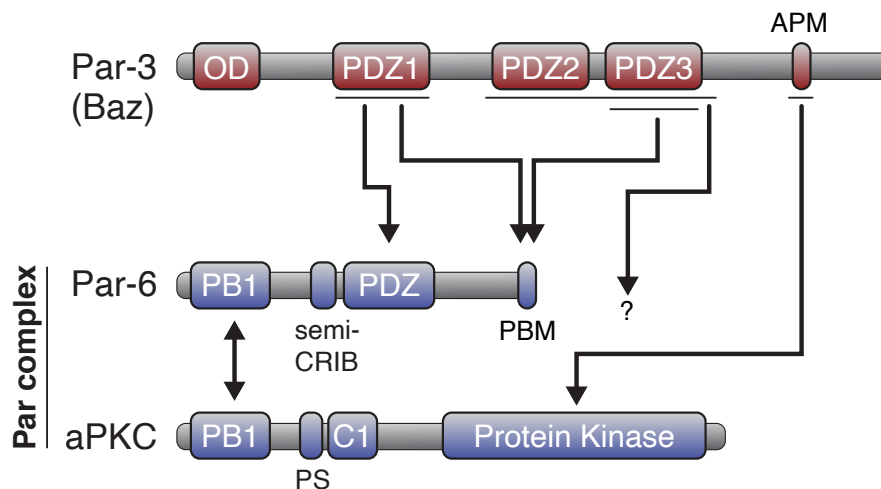

Figure 8: Par-3 interacts with aPKC and Par-6. All previously reported binding interactions between aPKC, Par-6, and Par-3. Abbreviations: APM – aPKC Phosphorylation Motif. PBM – PDZ Binding Motif. PS – Pseudosubstrate. OD – Oligomerization Domain.

identified between aPKC, Par-6, and Par-3 (Joberty et al., 2000; Kemphues et al., 1988; Lin et al., 2000; Nagai-Tamai et al., 2002; Renschler et al., 2018; Soriano et al., 2016; Tabuse et al., 1998; Wodarz et al., 2000). In this section I will discuss what is currently known about Par-3, how it interacts with the Par-complex, and what this means for its regulation and localization of aPKC activity.

Localization of Par-3 is dynamic

Par-3 localization to the cortex initially depends on a number of factors including oligomerization through its OD, association with membrane lipids, and its interaction with other proteins (Feng et al., 2007, 2007; Wu et al., 2007). Interestingly, in many cell types including neuroblasts, epithelia, and the *C. elegans* zygote, polarization of Par-3 does not depend on the Par-complex. In epithelia, while apical localization does not depend on the Par-complex, its subsequent junctional association does (Morais-de-Sá et al., 2010). In asymmetrically dividing cells such as the *C. elegans* zygote, Par-3 initially localizes to the posterior, where it forms puncta that strongly co-localize with the Par-complex as cortical flows move it towards the anterior pole (Rodriguez et al., 2017; Wang et al., 2017). The OD is critical for Par-3 localization to the cortex where self-oligomerization increases the lipid binding affinity to the cortex (Dickinson et al., 2017; Feng et al., 2007; Li et al., 2010a). Disruption of the oligomerization domain significantly diminishes cortical puncta (Dickinson et al., 2017). Throughout the cell cycle, Par-3/Par-complex puncta coalesce to form an apical cap much like the localization of aPKC observed in *Drosophila* neuroblasts (Oon and Prehoda, 2019; Rodriguez et al., 2017). These observations along with the fact that Par-3 is required for

Par-complex polarization, have led to models where Par-3 forms a stable inhibited interaction with the Par-complex, and that this complex assembly is crucial for the regulation and polarization of aPKC activity (Rodriguez et al., 2017). How Par-3 polarizes the Par-complex and why Par-3 is necessary, considering Cdc42 would seem to be sufficient to drive Par-complex polarization, has led to complex and often controversial models.

The Par-3 aPKC phosphorylation motif regulates aPKC activity through a stable and inhibited complex.

Par-3 was initially reported to interact with aPKC through a region COOH-terminal to the PDZ domains and this interaction was shown to facilitate the proper polarization of cells by localizing aPKC to the apical domain (Izumi et al., 1998; Nagai-Tamai et al., 2002). This region was shown to bind with “high affinity” to the kinase domain of aPKC and to contain a serine residue that is phosphorylated both *in vitro* and *in vivo* (Nagai-Tamai et al., 2002). Interestingly, the authors concluded that this was a regulatory mechanism to dissociate Par-3 from aPKC. It is important to note that this is a general mechanism of all kinases where phosphorylation of its substrate destabilizes the interaction with the kinase. As such, this does not seem to be a regulatory mechanism unless activity of the kinase were to be regulated or the phosphorylation event was allosterically regulating another interaction. Neither of these were shown as the C-tail was indeed phosphorylated and independent of any activating steps. This was the first instance of Par-3 mediated regulation of aPKC activity that has led to models that suggest

Par-3 can form a stable inhibited complex with aPKC through what is normally thought of as a transient enzyme/substrate interaction.

More recently it has been reported that the human Par-3 APM binds to the catalytic site of aPKC's kinase domain with high affinity and does not get phosphorylated. This was a very surprising result as it had been previously shown that the mammalian, fly, and worm Par-3 could all be phosphorylated by aPKC (Li et al., 2010a; Lin et al., 2000; Morais-de-Sá et al., 2010; Nagai-Tamai et al., 2002). Importantly, all of these studies used radiolabeled ATP to show the direct phosphorylation of Par-3, whereas Soriano et al used a less sensitive indirect method to detect the release of ADP (Soriano et al., 2016). These observations led the authors to conclude that Par-3 forms a stable inhibited interaction with aPKC and that something else must happen to activate aPKC in order to phosphorylate Par-3 and release it from the complex (Soriano et al., 2016).

This ability of aPKC to have different levels of activation depending on the substrate has certainly led to some confusion, perpetuated by the fact that an activating factor has yet to be identified. Furthermore, this interaction was suggested to play an inhibitory role, defining a new class of aPKC substrates as inhibitor substrates that are unique from classical substrates. While this is an intriguing model for how Par-3 could both polarize and regulate aPKC activity, it directly contradicts previous *in vivo* studies that suggest Par-3 positively regulates aPKC activity (Achilleos et al., 2010; McCaffrey and Macara, 2009; Wirtz-Peitz et al., 2008). For example, over-expression of Par-3 in *Drosophila* leads to the over proliferation of neuroblasts, indicative of over-active aPKC (Wirtz-Peitz et al., 2008). Expression of a phosphomimetic Par-3 in *Drosophila* epithelia

leads to constricted membranes, however, Lgl is still polarized, indicating aPKC is active (Morais-de-Sá et al., 2010). Recently, Rodriguez et al developed an inducible reporter assay to target aPKC to the *C. elegans* embryo cortical domain in the presence of PMA (Rodriguez et al., 2017). In the absence of PMA, aPKC was cytoplasmic and the posteriorly localized Par-2 was cortical. In WT cells, PMA induced aPKC to the cortex, clearing Par-2. However, under Par-3 RNAi conditions, aPKC failed to clear Par-2 from the membrane. This led the authors to conclude that there is a functional consequence for Par-3 inhibition of aPKC, apparently reconciling this controversy between *in vivo* and *in vitro* data.

It is fascinating that these two studies by Soriano et al. and Rodriguez et al. have redefined our current understanding of the role of Par-3 in regulating aPKC activity, contradicting all other functional evidence that suggests otherwise. This new model now suggests that Par-3 forms a functionally distinct inhibited state that is required for the proper regulation of aPKC activity and polarization. In chapter II I revisit the role of Par-3 inhibition and show that Par-3's APM is not unique to any other aPKC substrate and that it is indeed phosphorylated by aPKC regardless of activating factors. Furthermore, consistent with first principles of enzyme kinetics, all substrates can compete with other substrates for access to the kinase active site and thus “inhibitor substrates” are just substrates.

Binding interactions between the Par-complex and the Par-3 PDZ domains.

In addition to Par-3's interaction with aPKC through its APM, at least 4 additional interactions have been reported between Par-3 and the Par-complex (Figure 8). Initially

it was shown that the Par-3 PDZ1 domain could interact directly with the PDZ domain of Par-6 (Joberty et al., 2000; Lin et al., 2000; Morais-de-Sá et al., 2010). It was speculated that this interaction occurred through a process of PDZ stacking which occurs between the PDZ domain of neuronal nitric oxide synthase (nNos) and the PDZ domain of syntrophin (Hillier et al., 1999). Here, a β -finger from nNos acts as a COOH-terminal peptide, binding into the ligand binding groove of syntrophin. Unlike this example, there is little evidence to suggest that Par-3 PDZ1 binds to Par-6 PDZ domain in a similar fashion. Furthermore, two decades have passed since this initial discovery by two independent groups, yet the regulation of this interaction is still unknown. The importance of this interaction has been controversial since its initial discovery. For example, co-expression of Par-3 lacking the APM and Par-6 fail to co-immunoprecipitate in COS cells (Nagai-Tamai et al., 2002). More recently it was shown by NMR that neither *D. Melanogaster* nor *C. elegans* PDZ1 directly interact with Par-6 PDZ domain calling into question the relevance of this interaction (Renschler et al., 2018). Furthermore, there is no genetic evidence to suggest that Par-3 PDZ1 is required for its interaction with the Par-complex. In fact, in *C. elegans* it was shown that Par-3 mutants that lacked the PDZ1 domain could rescue the Par-3 null mutant phenotype (Li et al., 2010a).

More recently, Par-6 was shown to interact with Par-3's PDZ1 and PDZ3 domains through a novel Par-6 PBM (Renschler et al., 2018). The affinities of the PDZ1 and PDZ3 for Par-6 PBM were quite low (216 μ M and 54 μ M respectively), however binding avidity with other previously reported interactions may strengthen these relatively weak interactions. Furthermore, the PDZ1 and PDZ3 may work redundantly

allowing for the binding of two Par-complex molecules for each Par-3. In combination with the OD, this would allow for the formation of large oligomeric complexes shown to be important for Par-complex polarization (Dickinson et al., 2017). However, the physiological relevance of the Par-6 PBM is questionable. Deletion of the Par-6 PBM on Par-6 apical localization in *Drosophila epithelia* alone was not statistically significant when compared with WT whereas deletion of the PDZ domain alone was (Renschler et al., 2018). Interestingly, deletion of both the PDZ and the PBM increased the mis-localization of Par-6 when compared with the deletion of the PDZ alone leading the authors to conclude that the PDZ and the PBM are redundant.

Finally, a Yeast-2-Hybrid screen was used to show that the Par-3 PDZ2-PDZ3 could interact with aPKC but could not interact with either domain alone (Wodarz et al., 2000). Unfortunately, the consequences of these mutations were not assessed *in vivo*. In chapter III I investigate the interactions between Par-3 and the highly purified and reconstituted Par-complex, re-defining the molecular mechanisms that lead to complex formation.

Knowledge Gap: The complex and controversial nature of Par-3's interaction with the Par-complex.

With no less than five distinct interactions between Par-3 and the Par-complex, the mechanisms that lead to aPKC regulation and complex assembly are no doubt controversial. Furthermore, one of these interactions is an enzyme/substrate interaction that is normally thought of as transient yet has been proposed to be a regulated interaction that inhibits aPKC activity, requiring additional inputs for phosphorylation.

Complicating the issue is that in no context that we are aware of has it been demonstrated that any of the proposed interactions are required for the regulation of Par-complex activity or apical polarization *in vivo*. It is certainly possible that the lack of a phenotype is due to redundancy between all of these interactions, and only when you remove all possible interactions (such as a Par-3 null) do you get the expected phenotype. Further complicating this issue is that PDZ domains are promiscuous and may serve multiple functions. For example, the PDZ2 domain has been shown to bind to PIP lipids while the PDZ3 interacts with the lipid phosphatase, PTEN (Wu et al., 2007). Additionally, these interactions may have different roles depending on the cellular context. This does raise an interesting question regarding the necessity of having all of these interactions and if all of these interactions are required, what regulates them. For Par-3 to act to recruit the Par-complex to the apical domain, it must form a stable complex whose binding is regulated. The current models suggest that Par-3 forms a stable interaction with the Par-complex through an inhibited enzyme/substrate interaction and something else must happen to activate Par-3 phosphorylation and subsequent dissociation of the Par-complex (Lang and Munro, 2017; Wen and Zhang, 2018). Furthermore, it has been speculated that Cdc42 and Par-3 are mutually exclusive in their interaction with the Par-complex and that Cdc42 may activate aPKC's activity (Rodriguez et al., 2017). This is an attractive model, where Par-3 recruits an inactive stable complex until it is positioned at the apical membrane where active Cdc42 binding allows for the phosphorylation and dissociation of Par-3 from the Par-complex.

A caveat to all previously identified binding interactions is that these were all studied in the context of individual domains and as such it is difficult to determine the

requirements of these interactions for complex formation. Additionally, working with individual domains limits the ability to look at redundancy or cooperation between binding interactions. In order to bring clarity to these controversial issues as well as begin to fully understand the regulatory role of Par-3 on the Par-complex, I have addressed two main questions:

1. Is Par-3 unique to other aPKC substrates in that its APM inhibits kinase activity until additional factors fully activate aPKC?
2. What binding interactions are required for complex formation between Par-6, aPKC, and Par-3?

The answers to these questions will help further our understanding of the molecular mechanisms that govern complex formation between Par-3 and the Par-complex, with the ultimate goal in understanding the complex mechanisms that lead to the regulation of aPKC.

aPKC is polarized by Par-3 and Cdc42 in diverse and specialized cells. Are the mechanisms of aPKC regulation conserved in different cell types? While regulation of the intricate interplay between aPKC, Par-6, Par-3 and Cdc42 may vary, the underlying molecular mechanisms that govern the interactions between these four proteins may not. Therefore, defining the requirements for complex formation is paramount to our understanding of aPKC regulation and more generally how cells polarize throughout the metazoan landscape.

Bridge to Chapter II

In this chapter I have given an overview of the apical polarity network, including the key players that are all required for the proper polarization of cells with special attention to Par-3's role in Par-complex polarization. Additionally, I reflected on the controversial nature surrounding Par-3's role in regulating Par-complex activity and polarization. In the following chapter I will argue that the Par-3 APM binding to the kinase domain is a transient interaction, like all enzyme/substrate interactions, and thus does not support a mechanism for the stable recruitment of the Par-complex to the apical membrane. This study clearly demonstrates that Par-3's APM is in fact phosphorylated in the absence of any additional inputs. Furthermore, I show that while Par-3 can inhibit aPKC activity, this is not unique to Par-3 as all substrates can inhibit kinase activity as is consistent with first principles.

CHAPTER II
PHOSPHORYLATION OF PAR-3 BY ATYPICAL PROTEIN KINASE C AND
COMPETITION BETWEEN ITS SUBSTRATES

*This chapter contains previously published co-authored material.

Holly, R.W., Prehoda, K.E. (2019) Phosphorylation of Par-3 by Atypical Protein Kinase C and Competition Between its Substrates. *Dev Cell* 49 (5), 678-679

Author contributions: R.H performed all the experimental work. K.E.P and RH were both involved in the experimental design. K.E.P and R.H wrote the manuscript. K.E.P directed the program

Phosphorylation of the polarity protein Par-3 by atypical Protein Kinase C (aPKC) has been observed for the fly (Morais-de-Sá et al., 2010), worm (Li et al., 2010a), and mouse (Lin et al., 2000) proteins and is important for epithelial polarity (Tepass, 2012). Recently Soriano et al. failed to observe phosphorylation of human Par-3 (Soriano et al., 2016), which led them to conclude that Par-3 forms a stable complex with aPKC (inhibiting phosphorylation of other substrates) and is not phosphorylated and released until an unknown activating step occurs. However, they used an assay that detects ADP product that is relatively insensitive compared to the standard radioactive protein product assay used in previous studies. Here, we use the more sensitive assay to examine aPKC's

phosphorylation of human Par-3 and other substrates, and to measure how well aPKC substrates compete with each other for aPKC's catalytic activity.

We readily detected phosphorylation of human Par-3 by the human aPKC kinase domain, both for the Par-3 peptide used in the original study (provided by the authors; Figure 9A) and for an MBP fusion of Par-3's aPKC recognition sequence, known as CR3 (Figure 9B). We also determined the kinetic parameters k_{cat} and K_M for aPKC phosphorylation of human and fly Par-3, and several other substrates. We found that while the maximal rate constant for human CR3 phosphorylation (k_{cat}) is relatively low compared to some other aPKC substrates (Figure 9C), it is higher than k_{cat} for many other enzyme-substrates (Bar-Even et al., 2011). Furthermore, the phosphorylation activity of human Par-3 is similar to fly Par-3 and other aPKC substrates in terms of catalytic efficiency (k_{cat}/K_M), a standard measure of substrate quality (Figure 9C). Thus, no activation step is required for the human Par-3 CR3 sequence to be phosphorylated by the human aPKC kinase domain.

Soriano et al. also concluded that the human Par-3 CR3 specifically inhibits the aPKC kinase domain and defined two classes of substrates, "substrates" (those that are unable to inhibit) and "inhibitor substrates" (those that can). It is important to note that all substrates compete with each other for access to the active site (Fersht, 1999). However, Soriano et al. concluded that inhibition of aPKC is specific to Par-3 because they observed that another aPKC substrate, Par-1, does not inhibit: "In contrast, peptides from other known aPKC substrates such as Par1 were efficiently phosphorylated and were unable to inhibit". However, the Par-1 inhibition data were omitted from the paper, and furthermore they detected inhibition by monitoring the amount of ADP produced when a

model substrate was phosphorylated and the candidate “inhibitor” is increased in concentration (Figure 9D), and this assay is susceptible to false negatives (i.e. indicating a substrate doesn’t inhibit when it does). This is due to the inability of the ADP assay to distinguish between phosphorylation of the model substrate and candidate inhibitor (phosphorylation of either produces ADP; Figure 9E). To determine whether substrates other than Par-3 inhibit aPKC we monitored phosphorylation of the model substrate used by Soriano et al. using the radioactive protein product assay, which does not have this limitation. All substrates tested, including Par-1 and Numb, inhibited aPKC phosphorylation of the model substrate, although with varying efficiencies (Figure 9F, G). We also found that Par-1 inhibited phosphorylation of Par-3 (Figure 9H). Thus, we do not believe division of aPKC substrates into two categories – those that are able to inhibit phosphorylation other substrates, and those that are unable – is useful because the latter category doesn’t exist: all substrates compete with one another for access to the active site.

Soriano et al. also concluded that Par-3 CR3 inhibition of aPKC is functionally important based on experiments assessing the effect of fly Par-3 (aka Bazooka; Baz) CR3 mutations on epithelial polarity. The authors assumed that the CR3 mutations solely affected Par-3’s ability to inhibit aPKC’s phosphorylation of other substrates, but we note that the recognition sequence within a protein kinase substrate plays at least two roles, mediating binding to the kinase’s active site so the substrate can be phosphorylated, and interacting with downstream components, in addition to any putative role in inhibiting the enzyme. Thus, mutations in the CR3 sequence could influence the amount of CR3 that is phosphorylated and impair interactions with other factors required for function, and one

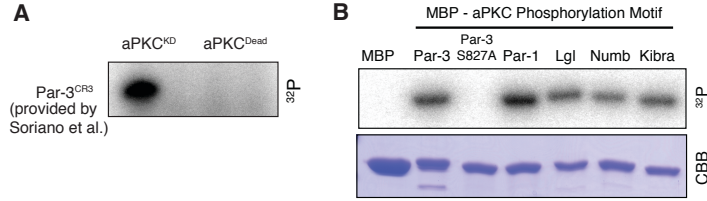

C

Substrate	K_M (μM)	k_{cat} (s^{-1})	Catalytic Efficiency ($\mu M^{-1}s^{-1}$)
hPar-3 ^{CR3}	0.24 ± 0.15	0.15 ± 0.02	0.41 ± 0.08
hPar-3 ^{CR3} (AAT)	11.8 ± 2.02	1.9 ± 0.13	0.17 ± 0.04
hPar-1 ^{APM}	16.6 ± 2.90	1.91 ± 0.14	0.12 ± 0.02
hNumb ^{APM}	0.21 ± 0.08	1.12 ± 0.08	6.2 ± 0.14
hLgl ^{APM}	0.35 ± 0.11	0.72 ± 0.05	2.1 ± 0.53
dPar-3 ^{CR3}	1.4 ± 0.52	0.92 ± 0.08	0.72 ± 0.22

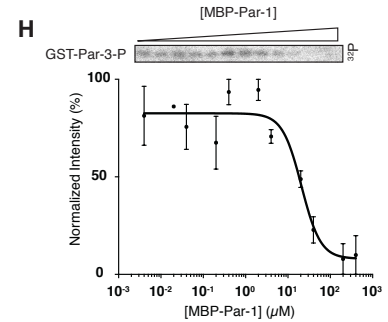
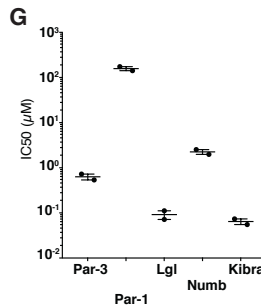
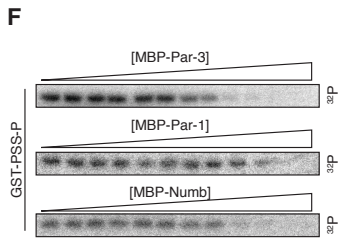
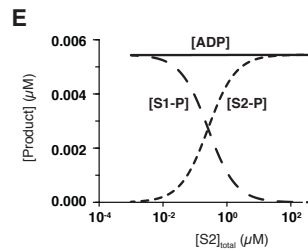
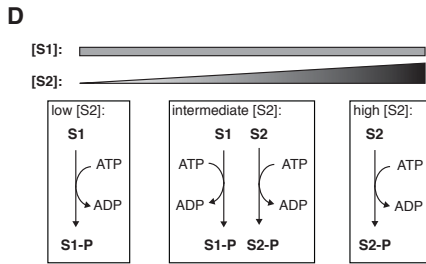

I

Protein	Residues
Human aPKC kinase domain	248-596
Fly aPKC kinase domain	259-606
Human Par-3 CR3	816-834
Fly Par-3 CR3	969-987
Human Par-1 APM	603-621
Human Numb APM	1-14
Human Kibra APM	958-972
Model Substrate (PSS)	149-164 (A159S)
Human PKC epsilon pseudosubstrate	

Figure 9 (previous page): Phosphorylation of Par-3 and other substrates by atypical Protein Kinase C and competition between its substrates.

(A) *The human Par-3 CR3 peptide is phosphorylated by the human aPKC kinase domain.*

Radioactive signal from phosphorimaging (^{32}P) from the Par-3 CR3 peptide (provided by Soriano et al.) is shown after incubation with ^{32}P -ATP and aPKC and tris-tricine gel electrophoresis. The signal from a reaction using a “Dead” version of the kinase harboring an inactivating D388A mutation is included to show the level of background phosphorylation signal.

(B) *Maltose Binding Protein (MBP) fusions of aPKC Phosphorylation Motifs (APMs) from several substrates, including Par-3, are phosphorylated by the aPKC kinase domain.*

Radioactive signal from the designated proteins are shown after incubation with ^{32}P -ATP and aPKC and polyacrylamide gel electrophoresis. The signal from reactions containing MBP and MBP fusion of Par-3 CR3 with its phosphorylated residue mutated to alanine (S827A) are included to show the level of background phosphorylation signal. The radioactivity signal from phosphorimaging (^{32}P) and total protein with Coomassie Brilliant Blue (CBB) are shown.

(C) *Kinetic parameters of aPKC substrates determined by measuring the dependence of reaction rates on substrate concentration.* The kinetic parameters k_{cat} and K_{M} were determined for each substrate from the substrate concentration dependence of the initial rate. The catalytic efficiency ($k_{\text{cat}}/K_{\text{M}}$), a standard measure of substrate quality, is also shown. Errors represent standard error from three experimental trials. The kinase domain from the species corresponding to the appropriate substrate was used for each experiment. aPKC Phosphorylation Motif (APM). CR3 is the APM for Par-3.

(D) *Substrate competition experimental scheme.* A “model substrate” (S1) is held at a constant concentration while the concentration of a test substrate (S2) is varied. At low concentrations of S2, phosphorylation of S1 predominates. At intermediate concentrations, both substrates are phosphorylated. At high concentrations, phosphorylation of S1 predominates.

(E) *Monitoring substrate competition with ADP concentration can lead to false negatives.*

Using kinetic modeling we identified parameters in which monitoring ADP would not be sensitive to competition. This deficiency arises because the ADP assay cannot distinguish between phosphorylation of the two protein substrates, S1 and S2 (phosphorylation of either substrate produces ADP). As the enzyme transitions from the model protein substrate to the “inhibitor” substrate (e.g. as the concentration of competitive substrate is increased), ADP continues to be produced and detected by the assay. If the kinetic properties of the substrates were such that ADP was produced in the same amount, no change in signal would be observed even if the competitive substrate very effectively inhibited phosphorylation of the model substrate (i.e. a false negative), as is the case in this example where S1 and S2 are phosphorylated at roughly the same rate. Although S2 completely inhibits phosphorylation of S1 at high concentrations of S2, this effect does not influence the amount of ADP produced.

(F) *Detection of substrate competition using the radioactive protein product assay.* Because the ADP concentration assay is prone to false negatives when detecting substrate competition, we performed the competition experiment using the radioactive protein product assay with a panel of aPKC substrates. This assay directly detects protein product and can therefore be used to specifically monitor the extent of model substrate phosphorylation. We used this assay to measure inhibition of “model substrate” (GST-PSS) phosphorylation by the Par-3 CR3 and a number of

other known aPKC substrates. Phosphorylation of the model substrate is shown after polyacrylamide gel electrophoresis and phosphorimaging as a function of the concentrations of MBP fusions of Par-3, Par-1, Numb APMs.

(G) All aPKC substrates inhibit phosphorylation of the model substrate. The IC₅₀ values for inhibition of model substrate phosphorylation by Par-3, Par-1, Lgl, Kibra, and Numb APMs are shown. We observed inhibition of model substrate phosphorylation with all tested aPKC substrates, including Par-1 and Numb. Error bars represent standard error from the plotted experimental trials.

(H) The Par-1 APM inhibits phosphorylation of the Par-3 CR3. The amount of Par-3 CR3 phosphorylation by aPKC is shown as a function of Par-1 APM concentration. Analysis of the phosphorimager intensities (graph below) yields an IC₅₀ of 23 μM. Error bars represent standard error from two experimental trials.

(I) Table of constructs used in this study.

or both of these effects could lead to polarity phenotypes. We tested one such CR3 mutation (“AAT”) used by Soriano et al. and found that it significantly reduces its quality as an aPKC substrate (Figure 9C). In fact, Soriano et al. found that another Par-3 CR3 mutation (“AXA”) leads to a significant reduction in phosphorylation in cells (see their Figure 5F). We conclude that the polarity phenotypes observed by Soriano et al. could arise simply from the fact that less phosphorylated Par-3 is produced in the CR3 mutant context. More broadly, these results emphasize the difficulty of isolating potential substrate competition as an experimental variable.

Finally, we note that current *in vivo* observations do not strongly support a role for Par-3 in inhibiting aPKC’s catalytic activity. For example, when Par-3 and aPKC are colocalized, aPKC is active as assessed by its ability to clear other substrates from the cortex (Atwood et al., 2007; Morais-de-Sá et al., 2010). In no context that we are aware of does loss of Par-3 lead to increased aPKC catalytic activity, as would be expected for an inhibitor of catalytic activity. Even for substrates such as Lgl that are known to

antagonize aPKC, this function is most clearly related to an effect on aPKC's localization, not its catalytic activity (Grifoni et al., 2007; Lee et al., 2006).

In conclusion, we have found that human Par-3 CR3 is phosphorylated by the aPKC kinase domain, as is the case for the fly, worm, and mouse orthologues. We also found that all substrates can inhibit aPKC's ability to phosphorylate another substrate, consistent with the general principle that substrates compete with one another for access to the active site. While these results do not preclude the possibility that activating steps are involved in Par-3 CR3 phosphorylation by the aPKC kinase domain, or that CR3 inhibition of aPKC is functionally relevant, they do call into question the key observations that motivate both potential activities and the separation of aPKC substrates into "substrate" and "inhibitor substrate" categories. Further *in vitro* studies with the fully reconstituted Par complex, and *in vivo* analyses of aPKC activity will be required for a complete understanding of Par-3's role in regulating aPKC-mediated polarity.

METHODS

Expression and Purification of aPKC kinase domain.

The pCMV plasmid containing the aPKC coding sequence and NH₂-terminal His₆ affinity tag were transfected into HEK293-F suspension cells using 293fectin (Thermo Fisher) and grown in shaker flasks for 24h at 37°C. Cells were collected by centrifugation, resuspended in nickel lysis buffer (50 mM NH₃PO₄, 300 mM NaCl, 10 mM Imidazole, pH 8.0), and lysed by probe sonication. After clearing cellular debris by centrifugation, aPKC protein was precipitated by gentle mixing with ammonium sulfate

to a final concentration of 45% (w/v) for 30 minutes and then collected by centrifugation. Precipitated protein was resuspended in nickel lysis buffer and gently mixed with Ni²⁺-nitrilotriacetic acid resin for 45 minutes. Resin was washed 2x with nickel lysis buffer supplemented with 5 mM MgCl₂ and 100 μM ATP followed by a final wash with nickel lysis buffer. Protein was eluted with nickel elution buffer (50 mM NH₃PO₄, 300 mM NaCl, 300 mM Imidazole, pH 8.0) and buffer exchanged for 20mM Tris, pH 7.5, 100 mM NaCl, 1mM DTT, 5 mM MgCl₂, and 100 μM ATP using a PD10 desalting column. Finally, protein was purified by Source Q anion exchange chromatography with a salt gradient from 100 mM to 550 mM. Fractions from the elution peak containing aPKC phosphorylated at the activation loop and turn motif, as verified by reactivity with phosphospecific antibodies (Santa Cruz Biotech), were pooled and buffer shifted to 20 mM HEPES, pH 7.5, 100 mM NaCl, 5 mM MgCl₂, 100 μM ATP, and 1 mM DTT, followed by flash freezing and storage at -80°C until use. Kinase domains were quantified by western blot analysis using a standard curve generated with a sample of known concentration using an anti-aPKC antibody (Santa Cruz Biotech).

Expression and Purification of Substrates.

Substrate sequences were cloned into either pMAL or pGEX bacterial expression vectors allowing substrates to be tagged with either NH₂-terminal MBP or GST affinity tags, respectively. Proteins were expressed in transformed *E. coli* BL21(DE3) followed by purification on amylose (MBP) or glutathione (GST) affinity resins using standard methods. Proteins were buffer shifted over PD10 columns (GE Healthcare) to 20 mM HEPES, 100 mM NaCl, 1 mM DTT, pH 7.5 followed by flash freezing and storage at -

80°C. Bacterially expressed substrates were quantified by comparing Coomassie Brilliant Blue staining to that of a standard curve generated using known concentrations of Bovine Serum Albumin. *Enzyme kinetics assays.* Assays were conducted in 18.1 mM HEPES, 90 mM NaCl, 4.6 mM MgCl₂, 0.1 mM ATP (1 μCi γ-³²P), and 0.0045% Tween at 21° C, pH 7.5. The kinase, at a final concentration of 100 nM for single point assays and between 0.125 nM and 1 nM for substrate concentration dependence assays (i.e. Michaelis Menten kinetics), was incubated for 20 minutes followed by addition of substrate (1 μM for single point assays and between 0 and 50 μM for substrate concentration dependence assays) to initiate the reaction. Single point assay samples were quenched after 30 minutes with SDS loading dye and subjected to polyacrylamide gel electrophoresis to separate substrates from unreacted ATP, followed by final analysis by phosphorimaging. For substrate concentration dependence samples, the reaction was ended after 10 minutes by addition of quench buffer to a final concentration of 68 mM H₃PO₄, 0.91 M NaCl, and 0.91 mM DTT and applied to a nitrocellulose membrane via a Minifold-1 slot blotter (Whatman) to separate product from unreacted ATP followed by phosphorimaging quantification. Intensities obtained by phosphorimaging were converted to product concentrations using a standard curve generated concomitantly using a phosphorylated standard. Initial rates were determined by linear fits to the time dependence of product formation using Prism 8 (GraphPad). The k_{cat} and K_M kinetic parameters were determined by fitting the dependence of initial rate on substrate concentration using Prism 8 which directly yielded K_M and V_{max} , and k_{cat} was determined by dividing V_{max} by the concentration of aPKC. Error was assessed by averaging the velocities of at least 3 independent experiments and taking the standard error.

Competition assays.

For competition assays, the pseudosubstrate from PKC epsilon was used as the model substrate with an alanine to serine mutation (“PSS”) containing an NH₂-terminal GST affinity tag (or Par-3 CR3 in the case of the Par-1 inhibition of Par-3 experiment shown in Figure S1H). Assays were conducted in 18.1 mM HEPES, 90 mM NaCl, 4.6 mM MgCl₂, 0.1 mM ATP (1 μCi γ-³²P), and 0.0045% Tween at 21 °C, pH 7.5. The kinase, at a final concentration of 0.25 nM was incubated for 20 minutes followed by the addition of substrates (20 μM GST-PSS and MBP-substrates titrated from 100 μM–1 nM). Reactions were quenched after 10 minutes with SDS loading dye and subjected to polyacrylamide gel electrophoresis to separate substrates from unreacted ATP, followed by final analysis by phosphorimaging. Band intensities were analyzed using ImageJ. IC₅₀ values were analyzed using Prism (GraphPad) by fitting with the inhibitor vs normalized response function. Error was assessed by averaging two independent experiments and determining the standard error.

Kinetic Simulations.

COPASI kinetic simulation software was used to simulate kinetic parameters that could lead to false negatives while using ADP detection technologies to analyze competitive inhibition between two competing substrates. For the simulations in Figure S1E, substrate 1 (S1) had a K_M of 105 μM and a k_{cat} of 0.44 s⁻¹ and was held at a constant concentration of 8 μM. Substrate 2 (S2) had a K_M and k_{cat} of 7 μM and 0.09 s⁻¹ respectively while the concentration was varied from 1.0 nM – 1.0 mM. The enzyme and

ATP concentrations were set to 1 nM and 100 μ M respectively. The concentrations of ADP, phosphorylated substrates (S1-P and S2-P) were evaluated after 10 minute simulation time, while varying the concentration of S2.

Acknowledgments

We thank Barry Thompson and Neil McDonald for helpful discussions and for providing the Par-3 CR3 peptide used in their original study. We also thank Brad Nolen, Nadia Singh, and members of the Prehoda Lab for helpful comments and discussions. This work was funded by grants from the NIH (GM068032 and GM127092)

Bridge to Chapter III

In this chapter I have argued that the interaction between the Par-3 APM and the aPKC kinase domain does not support a mechanism for apical recruitment of the Par-complex by Par-3. The interaction between the Par-3 APM and the kinase domain of aPKC is, like all enzyme/substrate interactions, transient. While the turnover of Par-3 is lower than other substrates, the catalytic efficiency is comparable with other known aPKC substrates. Furthermore, I show that while Par-3 does indeed inhibit aPKC catalytic activity, it does so comparable to other aPKC substrates and in fact all substrates can inhibit catalytic activity depending on the relative concentrations. In Chapter III I assess the role of all other reported interactions between Par-3 and purified reconstituted Par-complex. Surprisingly, I found that none of the previously reported interactions are required for complex assembly. However, we do identify a novel interaction that is

required for aPKC's apical polarization. This work is important to our understanding of the role Par-3 plays in polarizing the Par-complex.

CHAPTER III

A CONSERVED aPKC PDZ BINDING MOTIF INTERACTS WITH PAR-3 AND MEDIATES CORTICAL POLARITY.

*This chapter contains previously published co-authored material

Holly, R.W., Jones, K., Prehoda, K.E. (2020) A Conserved aPKC PDZ Binding Motif That Interacts With Par-3 and Mediates Cortical Polarity. *Current Biology*. 30 (5), 893-898.

Author contributions: R.H performed all in vitro experiments. K.J performed the in vivo experiments. K.E.P and R.H were both involved in the experimental design. K.E.P and R.H wrote the manuscript. K.E.P directed the research.

SUMMARY

Par-3 regulates animal cell polarity by targeting the Par complex proteins Par-6 and atypical Protein Kinase C (aPKC) to specific cortical sites. Although numerous physical interactions between Par-3 and the Par complex have been identified (Izumi et al., 1998; Joberty et al., 2000; Lin et al., 2000; Renschler et al., 2018; Soriano et al., 2016; Wodarz et al., 2000), we discovered a novel interaction between Par-3's second PDZ domain and a highly conserved aPKC PDZ binding motif (PBM) that is required in the context of the full-length, purified Par-6/aPKC complex. We also found that Par-3 is phosphorylated by the full Par complex and phosphorylation induces dissociation of the

Par-3 phosphorylation site from aPKC's kinase domain but does not disrupt the Par-3 PDZ2 – aPKC PBM interaction. In asymmetrically dividing *Drosophila* neuroblasts, the aPKC PBM is required for cortical targeting, consistent with its role in mediating a persistent interaction with Par-3. Our results define a physical connection that targets the Par complex to polarized sites on the cell membrane.

RESULTS AND DISCUSSION

Par complex phosphorylation of Par-3

The catalytic activity of aPKC defines mutually exclusive cortical domains in diverse animal cells (Lang and Munro, 2017; Venkei and Yamashita, 2018). Par-6 and aPKC are recruited to specific cellular sites where aPKC phosphorylation polarizes downstream factors by displacing them from the Par cortical domain. For example, in *Drosophila* neural stem cells or neuroblasts, the Par complex localizes to an apical cortical domain during mitosis where it excludes neuronal differentiation factors (Atwood and Prehoda, 2009; Rolls et al., 2003; Wodarz et al., 1999). Apical exclusion separates these factors into a distinct cortical domain at the basal cortex, which is segregated into the basal daughter cell following cytokinesis (Knoblich, 2010; Venkei and Yamashita, 2018). Par polarized factors such as Miranda and Numb contain sequences that bind the membrane but are also phosphorylation motifs for aPKC (Bailey and Prehoda, 2015). The direct connection of aPKC's catalytic activity to the polarization of downstream factors makes the regulatory pathways that control its cortical targeting critical to animal cell polarity.

In many cellular contexts, Par-3 (Bazooka in flies) is essential for recruitment of Par-6 and aPKC to specific cortical sites (Lang and Munro, 2017; Venkei and Yamashita, 2018; Wen and Zhang, 2018). Par-3's role in regulating Par complex cortical recruitment is thought to be direct because five physical interactions have been discovered with both Par-6 and aPKC (Izumi et al., 1998; Joberty et al., 2000; Lin et al., 2000; Renschler et al., 2018; Soriano et al., 2016; Wodarz et al., 2000) (Figure 10A). Four of the interactions involve at least one of Par-3's three PDZ protein interaction domains: Par-3 PDZ1 binding to the Par-6 PDZ domain (Joberty et al., 2000; Li et al., 2010b; Lin et al., 2000),

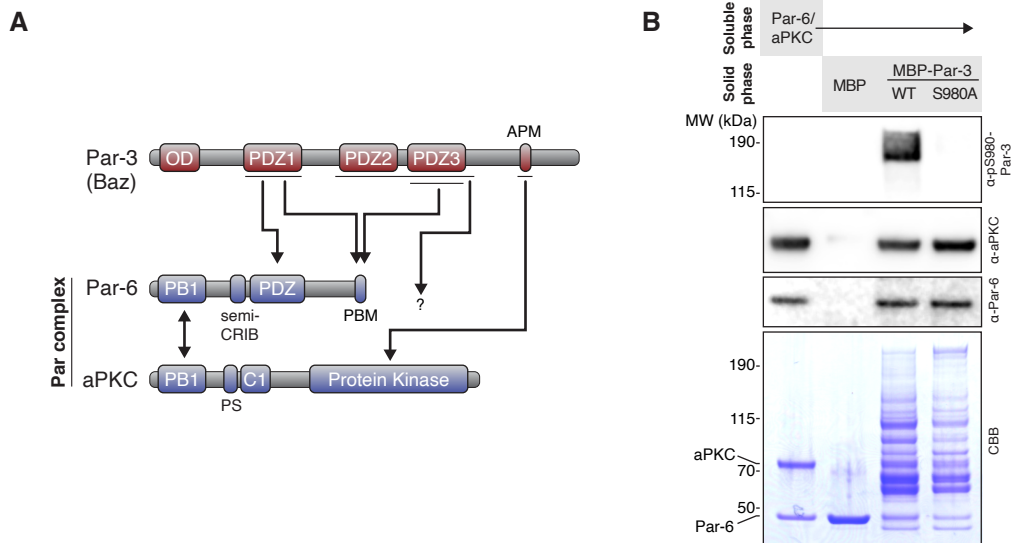

Figure 10 Par-6/aPKC binds and phosphorylates Par-3. (A) Domain structure (not to scale) and previously described Par-3 interactions with the Par complex. Single direction arrows define the five previously identified Par-3 interactions with Par-6/aPKC. PBM, PDZ Binding Motif; APM, aPKC Phosphorylation Motif (aka CR3); PS, pseudosubstrate. Double headed arrow denotes the interaction between Par-6 and aPKC. (B) Par-3 interaction with and phosphorylation by the Par complex. Solid phase (amylose resin) bound Maltose Binding Protein (MBP) fused Par-3 (MBP-Par-3 has an expected mass of 199.9 kDa) with the Par-6/aPKC complex. CBB, Coomassie Brilliant Blue; α-pS980-Par-3, antibody specific to the S980 site within the APM [17]. Shaded region indicates fraction applied to gel (soluble phase or solid phase components after mixing with soluble phase components and washing).

Par-3 PDZ1 and PDZ3 domain interactions with Par-6's PDZ Binding Motif (PBM) (Renschler et al., 2018), and an interaction with an undefined region of aPKC that requires both Par-3 PDZ2 and PDZ3 (Wodarz et al., 2000). Additionally, because Par-3 is an aPKC substrate, the aPKC kinase domain interacts with Par-3's aPKC Phosphorylation Motif (APM aka CR3). Although protein kinases are typically thought to interact transiently with their substrates, the interaction with the APM has been proposed to mediate complex assembly (Izumi et al., 1998; Nagai-Tamai et al., 2002; Soriano et al., 2016). Previous investigations used small fragments of the Par complex that did not contain all potential binding motifs, such that it was not possible to assess whether any of the interactions are required for binding in the context of the purified, full-length Par-6/aPKC complex. Furthermore, none of the interactions have been shown to be required for cortical targeting of aPKC in a functional context.

We investigated Par-3 interactions with the Par-6/aPKC complex by reconstituting full-length *Drosophila* Par-6 and aPKC. While we were able to purify the Par-6/aPKC complex to a high degree (Figure 10B), Par-3 is very large (157.4 kDa) and the Maltose Binding Protein fused Par-3 (MBP-Par-3; total mass 199.9 kDa) we were able to obtain included significant amounts of degradation products in addition to full-length protein. Nevertheless, using this preparation we were able to detect an interaction with reconstituted Par complex using a qualitative affinity chromatography (i.e. "pull-down") assay (Figure 10B). Additionally, we detected phosphate transfer to full-length Par-3 (and some smaller fragments with masses consistent with COOH-terminal truncations that contain the APM) using an antibody specific to the phosphorylated APM (Morais-de-Sá et al., 2010) (Figure 10B). Phosphorylation of Par-3 by aPKC has been

controversial (Holly and Prehoda, 2019; Soriano et al., 2016; Thompson and McDonald, 2019). This result contributes to our understanding of the process by demonstrating that aPKC phosphorylates Par-3 in the context of the full-length, purified Par complex in addition to the isolated catalytic domain and APM peptide (Holly and Prehoda, 2019).

Par-3 PDZ2 is required for interaction with the Par complex

Using the system of purified Par complex and MBP-fusions of full-length Par-3 and its degradation products, we attempted to identify Par-3 domains required for interaction with the full Par complex (Figure 11). We also tested the Par-6 PBM within the Par complex as it has been reported to bind both the Par-3 PDZ1 and PDZ3 domains

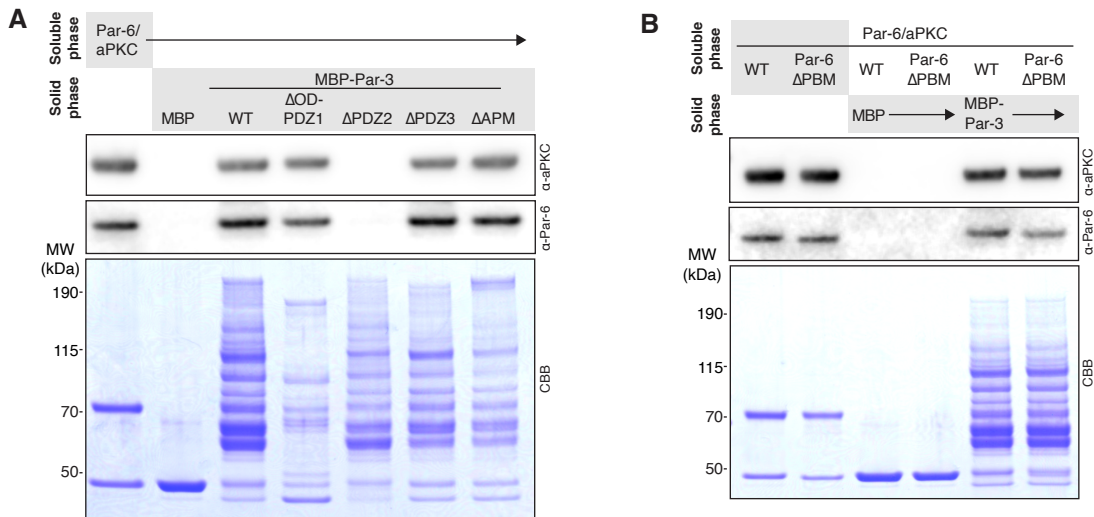

Figure 11: Par-3 PDZ2 is required for Par complex binding. (A) Effect of removing Par-3 domains on its interaction with the Par complex. Solid phase (amylose resin) bound Maltose Binding Protein (MBP) fused Par-3 (full length or the PDZ1-APM fragment) was incubated with soluble Par-6/aPKC complex. CBB, Coomassie Brilliant Blue. Shaded region indicates fraction applied to gel (soluble phase or solid phase components after mixing with soluble phase components and washing). (B) Effect of removing the Par-6 PDZ Binding Motif on the Par complex interaction with Par-3. Labeling as in A.

(Renschler et al., 2018) (Figure 11B). We included ATP in binding experiments since Par-3 is a substrate in the context of the full Par complex (Figure 11B). Using this experimental setup, we identified Par-3 PDZ2 as a required interaction domain for binding to the full Par complex (Figure 11).

A conserved aPKC PDZ Binding Motif is required for interaction with Par-3

To determine the mechanism by which Par-3 PDZ2 mediates binding to the Par complex, we first sought to identify the recognition site on the complex. The *Drosophila* aPKC COOH-terminal sequence has the characteristics of a “class 3” PDZ Binding Motif (PBM) (Figure 12A) and is consistent with the binding specificity of the PDZ2 domain as assessed using a phage display assay (Yu et al., 2014). The aPKC COOH-terminal sequence is also highly conserved among metazoan orthologues (Figure 12A), the same evolutionary interval in which Par-3 is found (Fahey and Degnan, 2010). We tested whether the aPKC COOH-terminus is required for the interaction with Par-3 by purifying Par complex lacking aPKC’s final six residues. As shown in Figure 12B, the aPKC COOH-terminus is required for Par-3’s interaction with the Par complex.

To test whether the Par-3 PDZ2 and aPKC COOH-terminus are sufficient for binding, we examined the interaction of the isolated motifs. As shown in Figure 12C, the isolated proteins are sufficient for complex assembly. In general, PDZ–PBM interactions are strongly dependent on the identity of the terminal residue and we found that Par-3 PDZ2 failed to bind the aPKC COOH-terminus when the final residue was mutated from valine to alanine (aPKC V606A; Figure 12C). We conclude that the aPKC COOH-

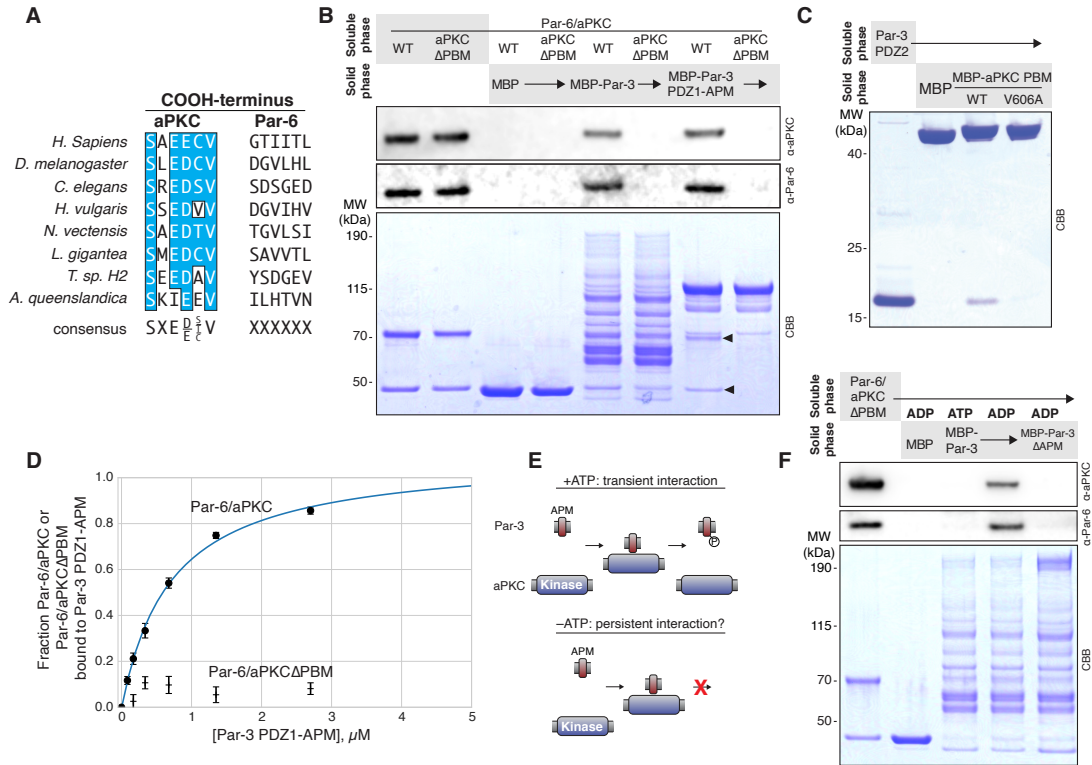

Figure 12: A conserved aPKC PDZ Binding Motif required for Par-3's interaction with the Par complex. (A) Sequence alignment of the aPKC and Par-6 COOH-terminuses from diverse metazoan organisms. (B) Effect of removing the aPKC PDZ Binding Motif on the Par complex interaction with Par-3. Solid phase (amylose resin) bound Maltose Binding Protein (MBP) fused Par-3 (full length or the PDZ1-APM fragment that contains all known interaction domains) was incubated with wild type Par-6/aPKC or the complex lacking aPKC's PBM (Par-6/aPKCΔPBM). Arrowheads indicate Par-6 and aPKC. CBB, Coomassie Brilliant Blue. Shaded region indicates fraction applied to gel (soluble phase or solid phase components after mixing with soluble phase components and washing). (C) Interaction of Par-3 PDZ2 with the aPKC PBM. Labeling as in B. For other organisms, see Figure S1A. (D) Comparison of Par-6/aPKC and Par-6/aPKCΔPBM binding to Par-3 PDZ1-APM using an equilibrium supernatant depletion assay [22]. Mean values of the fraction of the Par complex bound, as determined by both anti-Par-6 and anti-aPKC western blot analysis (see Figure S1B), from two experimental replicates are shown along with standard error at each concentration. (E) Schematic depicting how the lack of ATP may convert a transient interaction between the Par-3 APM and the aPKC kinase domain into a persistent one. (F) Effect of nucleotide on the interaction of Par-3 with Par-6/aPKCΔPBM. Solid phase (amylose resin) bound Maltose Binding Protein (MBP) fused Par-3 (full length and with the specified interaction domains removed) was incubated with Par-6/aPKC lacking aPKC's PBM (Par-6/aPKCΔPBM). "ADP" or "ATP" indicates which nucleotide was present in the binding reaction. CBB, Coomassie Brilliant Blue. Shaded region indicates fraction applied to gel (soluble phase or solid phase components after mixing with soluble phase components and washing).

terminus is a bona fide PDZ Binding Motif (PBM). We also confirmed that the aPKC PBM and Par-3 PDZ2 interaction is broadly conserved across metazoans by examining orthologues from a chordate (human), a placozoan (*Trichoplax*), and a cnidarian (*Hydra*), in addition to the arthropod *Drosophila* (Figure S1A). We observed binding for each of the orthologous pairs indicating that the interaction is conserved across diverse metazoan organisms. Together, these results indicate that the Par-3 PDZ2 and aPKC PBM are sufficient for binding and their interaction is conserved across metazoa.

To assess the role of the Par-3 PDZ2–aPKC PBM interaction quantitatively, we implemented an equilibrium supernatant depletion assay (Pollard, 2010). We measured the affinity of the Par-3 PDZ1-APM for the Par complex, as this region could be purified to a level suitable for quantitative measurements (Figure 12B). Addition of Par-3 PDZ1-APM depleted Par-6 and aPKC from the supernatant consistent with a K_d of 0.7 μM (95% confidence interval of 0.5 – 0.9 μM ; Figures 12D, S2B). To determine the effect of disrupting the Par-3 PDZ2–aPKC PBM interaction on binding affinity, we examined Par-3 PDZ1-APM binding to Par-6/aPKC Δ PBM. We did not observe sufficient depletion of Par-6 and aPKC Δ PBM by PDZ1-APM to allow fitting to a binding isotherm (Figures 12D, S2B), indicating the absence of the aPKC PBM substantially decreases the affinity of the Par-3 interaction with the Par complex, consistent with the results of qualitative measurements (Figure 12B).

The role of Par-3 phosphorylation in its interaction with the Par complex

Our results indicate that the Par-3 PDZ2 and aPKC PBM are required for Par-3's interaction with the Par complex (Figures 11A, 12B). The requirement for these domains

suggests that the Par-3 phosphorylation site (i.e. APM) does not form a persistent interaction with the Par complex. However, this conclusion appears to be in conflict with previous work showing that the Par-3 APM is sufficient for binding to the aPKC kinase domain, both with binding assays and structure determination using x-ray crystallography (Soriano et al., 2016; Wang et al., 2012). Furthermore, a stable APM-kinase interaction forms the basis of a model in which the unphosphorylated Par-3 APM forms a stable, persistent interaction with the aPKC kinase domain that is not phosphorylated until an unknown activating event occurs (Soriano et al., 2016). The finding that Par-3 is phosphorylated by the full Par complex (Figure 10B) is inconsistent with this model, but it does not fully resolve whether the Par-3 APM is sufficient for forming a stable, persistent interaction with the Par complex (Soriano et al., 2016; Wang et al., 2012).

We hypothesized that the presence of ATP could influence the binding behavior of the Par-3 APM with the Par complex. A key difference between our experiments and previous reports is that our experiments included ATP, whereas previous binding experiments and structural analysis lacked ATP (Soriano et al., 2016; Wang et al., 2012). Without ATP, completion of the protein kinase catalytic cycle is not possible, and interactions that would otherwise form transiently could persist (Figure 12E).

We tested whether the Par-3 APM forms a stable, persistent interaction with the Par complex in the absence of ATP. We were able to detect binding between Par-3 and the Par complex after replacing ATP with ADP in a context where the Par-3 PDZ2 – aPKC PBM interaction is disrupted (Figure 12F). This interaction requires the APM, leading us to conclude that the Par-3 APM can form a persistent interaction with the Par complex, but only in the absence of ATP. When ATP is present the APM interacts

transiently with the Par complex, because it is phosphorylated (Figure 10B) and subsequently dissociates (Figures 12B,D,F). Under the same conditions, the Par-3 PDZ2 interaction with the Par complex is not disrupted, however (e.g. Figure 12B,D). Although it is possible to form a stalled complex between the Par-3 APM and the Par complex in the absence of ATP, we propose that persistent binding of the APM to the kinase domain due to the lack of ATP is unlikely *in vivo* because ATP concentrations are high under normal cellular conditions.

The aPKC PDZ Binding Motif is required for neuroblast polarization

Although numerous interactions have been identified between Par-3 and Par-6/aPKC (Izumi et al., 1998; Joberty et al., 2000; Lin et al., 2000; Renschler et al., 2018; Soriano et al., 2016; Wodarz et al., 2000), none have been demonstrated to be required for cortical targeting of the Par complex. In fact, the interactions of Par-6 with Par-3 have been shown to be dispensable for function (Li et al., 2010, 2010; Renschler et al., 2018). To determine if the Par-3 PDZ2 – aPKC PBM interaction is required for Par complex polarization, we investigated the localization of aPKC harboring the V606A PBM point mutation during neuroblast asymmetric division by expressing aPKC-V606A in larval brain neuroblasts and comparing its localization to that of wild-type aPKC. Consistent with previous observations (Oon and Prehoda, 2019; Rolls et al., 2003), we found that wild-type aPKC is polarized to a cortical crescent around the apical pole at metaphase (Figures 13A, B). In contrast, aPKC-V606A remained in the cytoplasm and was not recruited to the cortex, even though the localization of Par-3 was unaffected (Figures 13A-D). The aPKC-V606A protein also failed to be recruited to the apical cortex in

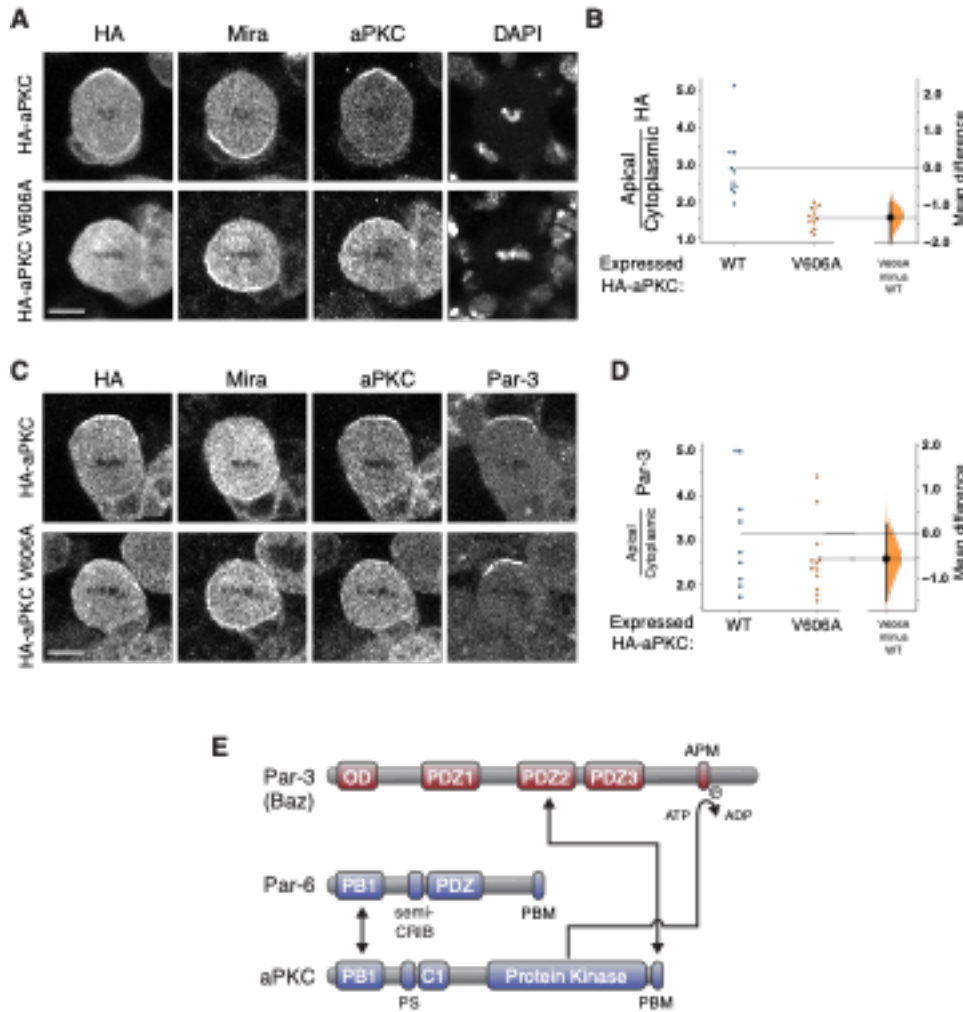

Figure 13: aPKC polarization requires its PDZ Binding Motif.

(A) Protein localization in metaphase neuroblasts expressing WT or V606A aPKC. The localization of HA-tagged WT or V606A aPKC, expressed using Worniu-GAL4/UAS, is shown with the basal marker Miranda, total aPKC (transgenically expressed and endogenous) using an anti-aPKC antibody, and DNA (DAPI). Scale bar is 5 μ m. A similar analysis in *aPKC* mutant neuroblasts is shown in Figure S2. (B) Gardner-Altman estimation plot of effect of the aPKC V606A mutation on aPKC cortical localization. Ratios of apical cortical to cytoplasmic anti-HA signal intensities are shown for individual metaphase neuroblasts expressing either HA-WT or HA-V606A aPKC. Statistics: Bootstrap 95% confidence interval (bar in “V606A minus WT” column). (C) Localization of Par-3 in metaphase neuroblasts expressing WT or V606A aPKC, as in panel d. (D) Gardner-Altman estimation plot of effect of the aPKC V606A mutation on Par-3 cortical localization. Apical cortical to cytoplasmic signal intensities of anti-Par-3 signals are shown for individual metaphase neuroblasts expressing either HA-WT or HA-V606A aPKC. Statistics: Statistics: Bootstrap 95% confidence interval (bar in “V606A minus WT” column). (E) Par-3 interactions with Par-6/aPKC analyzed in this study. The Par-3 PDZ2–aPKC PBM interaction forms a persistent connection while the aPKC kinase domain interacts transiently with the Par-3 APM when ATP is present.

aPKC PBM interaction is required for cortical recruitment and polarization of aPKC in neuroblasts.

We have examined the interaction of Par-3 with the full-length Par complex and found that Par-3 PDZ2 and a previously unrecognized PBM at the COOH-terminus of aPKC are required for complex assembly (Figure 13E). The Par-3 phosphorylation site (APM) can also form a persistent interaction with the aPKC kinase domain, but only if phosphorylation is not allowed to occur due to the absence of ATP. Unlike the APM–kinase domain interaction, the Par-3 PDZ2 interaction with the aPKC PBM is not influenced by the presence of ATP, suggesting that additional mechanisms besides APM phosphorylation must exist to dissociate Par-3 from the Par complex, an important component of current polarity models (Morais-de-Sá et al., 2010; Rodriguez et al., 2017; Wang et al., 2017).

The identification of Par-3 PDZ2 domain as a key factor in recruiting the Par complex to the cortex during animal cell polarization is consistent with previous work demonstrating that while Par-3 PDZ1 and 3 are dispensable in *C. elegans*, PDZ2 is required for cortical recruitment of Par-6 and aPKC (Li et al., 2010). It is also consistent with work in both *C. elegans* and *Drosophila* showing that the interaction of Par-6 with Par-3 is not required (Li et al., 2010; Renschler et al., 2018). In *Drosophila*, the role of PDZ2 is less clear but is known to be required for downstream effects on epithelial structure (McKinley et al., 2012). We suggest that the Par-3 PDZ2 – aPKC PBM interaction represents an important physical connection for animal cell polarity and that the reconstitution approach used to identify this interaction will likely be useful for understanding how other regulatory molecules, such as Cdc42, control polarity.

STAR METHODS

Lead contact and materials availability

All request for reagents should be directed to Lead Contact, Ken Prehoda.

(prehoda@uoregon.edu)

Experimental model and subject details

Animals: Drosophila

A mix of male and female larvae were used for all *in vivo* experiments. The strains used in this study were: ;Worniu-Gal4 (BDSC_56553), ; FRT-G13, aPKC^{K06403}/CyO (Gift from C.Q. Doe), and elav-Gal4, UAS-mCD8:GFP, hs:flp; FRT-G13, tubPGal80 (BDSC_5145).

In addition, two fly lines were created for this study, 3xHA-aPKC 1-606 and 3xHA-aPKC V606A. These were made using Phi-C31 integration. In brief, the coding region of aPKC wild-type (1-606) (A1Z9X0) or aPKC PBM mutant (V606A) were cloned into a pUAST vector (GenBank: EF362409.1) modified to contain an N-terminal 3xHA tag. Vector was injected into attP2 containing flies in a *y, w* background (BDSC_8622) and integrated using PhiC31 (BestGene, Inc.). F1 generation progeny were backcrossed to *y, w* adults and F2 progeny were screened for the presence of red eyes.

Method details

Expression and Purification of Par-complex

Plasmids (pCMV) containing the coding sequences for aPKC and His-Par-6 including the mutants aPKC Δ PBM or His-Par-6 Δ PBM were co-transfected into HEK293-F suspension cells using 293fectin (Thermo Fisher) and grown in shaker flasks for 60h at 37°C. Cells were collected by centrifugation at 1000 RPM x 3 minutes, resuspended in lysis buffer (50 mM NH₃PO₄, 300 mM NaCl, 10 mM Imidazole, pH 8.0), and lysed by probe sonication at 50% amplitude, 0.3s/0.7s pulse on/off, 3 x 1 minute. After clearing cellular debris by centrifugation at 15k RPM x 20 minutes, protein was gently mixed with 4mL HisPur Cobalt (ThermoFisher) resin for 45 minutes. Resin was washed twice with 20mL lysis buffer supplemented with 5 mM MgCl₂ and 100 μ M ATP followed by a final wash with 20mL nickel lysis buffer. Protein was eluted with elution buffer (50 mM NH₃PO₄, 300 mM NaCl, 300 mM Imidazole, pH 8.0) by gravity and buffer exchanged with 20 mM Tris, pH 7.5, 100 mM NaCl, 1 mM DTT, 5 mM MgCl₂, and 100 μ M ATP using a PD10 desalting column (GE Healthcare). Finally, protein was purified by Source Q anion exchange chromatography with a salt gradient from 100 mM to 550 mM. Fractions from the elution peak containing aPKC phosphorylated at the activation loop and turn motif, as verified by reactivity with phosphospecific antibodies (Rabbit α -PKC ζ p-410 Santa Cruz Biotech, sc-12894-R; Rabbit α -PKC p560 Abcam ab62372), were pooled concentrated to 2.5mL, and buffer shifted to 20 mM HEPES, pH 7.5, 100 mM NaCl, 5 mM MgCl₂, 100 μ M ATP, and 1 mM DTT, followed by concentration to ~400 μ L. Protein was aliquoted, flash frozen, and stored at -80°C until use. Par-complex was quantified by western blot analysis using a standard curve

generated with a sample of known concentration using an anti-aPKC antibody (Mouse α -PKC ζ H-1 Santa Cruz Biotech sc-17781).

Expression and Purification of Par-3.

Par-3 PDZ1 – APM (aa 309 – 991) was cloned (Gibson Cloning) into the pMal expression vector allowing for an NH₂-terminal MBP tag as well as a COOH-terminal His₆ tag to allow for dual affinity purification. Full length Par-3 (aa 1 - 1464) and all full length Par-3 domain deletion mutants were cloned into the pMal expression vector allowing for an NH₂-terminal MBP tag. Plasmids were transformed into *E. coli* BL21 (DE3) cells, plated on LB + AMP and allowed to grow for 18h at 37 C. Single colonies were picked to inoculate 100 mL of LB + AMP starter culture and grown for ~4h. Starter culture was used to inoculate 2L LB + AMP and cultures were grown to an OD₆₀₀ of 0.8 – 1, followed by a 3h induction with 500 μ M IPTG. Cell pellets were collected at 5000 RPM x 20 minutes and resuspended in lysis buffer (50 mM NH₃PO₄, 300 mM NaCl, 10 mM Imidazole, pH 8.0). Cell extracts were thawed under running water and lysed by probe sonication at 70% amplitude, 0.3s/0.7s pulse on/off, 3 x 1 minute. Cellular debris was cleared at 15,000 RPM x 20 minutes and supernatant was added to 5mL HisPur cobalt resin and incubated for 30 minutes at 4 C. Resin was washed 3 times with lysis buffer followed by elution with nickel elution buffer (50 mM NH₃PO₄, 300 mM NaCl, 300 mM Imidazole, pH 8.0). Fractions containing protein were pooled and concentrated to 2.5mL. Proteins were buffer shifted over PD10 desalting columns (GE Healthcare) to 20 mM Tris, pH 7.5, 200 mM NaCl, 1 mM DTT followed by flash freezing and storage at -80°C. Protein was quantified by Bradford and purity was assessed by SDS-Page. All other Par-3 constructs were cloned into pMal, pGex, or pET expression vectors allowing

for a single NH₂-terminal MBP, GST, or His tag. Proteins were expressed in transformed BL21 (DE3) competent cells as above. MBP-protein cell extracts were resuspended in MBP lysis buffer (20mM Tris, pH 7.5, 200mM NaCl, 1mM EDTA, 1mM DTT). GST-protein cell extracts were resuspended in GST lysis buffer (1x PBS, pH 7.4, 1mM DTT). His-protein cell extracts were resuspended in nickel lysis buffer (50 mM NH₃PO₄, 300 mM NaCl, 10 mM Imidazole, pH 8.0). Cells were lysed and cleared as above. For proteins used as bait in pull down assays, cleared lysate was aliquoted, flash frozen, and stored at -80 C. Purified proteins were prepared by incubating cleared lysates with 5mL of amylose, glutathione, or HisPur cobalt resin for 30 minutes at 4 C. Resin was washed 3x with either GST, MBP, or nickel lysis buffer. Proteins were then eluted with MBP, GST, or Nickel lysis buffer supplemented with 10 mM maltose, 10mM glutathione, or 300mM Imidazole, respectively. Fractions containing protein were pooled and concentrated to 2.5mL with Vivaspin 20 centrifugal concentrators. Proteins were buffer shifted to 20mM HEPES, pH 7.5, 100mM NaCl, 1mM DTT. Finally, proteins were concentrated to 500 μ L, aliquoted, flash frozen, and stored at -80 C.

Affinity chromatography interaction assay

Amylose or glutathione resin was loaded with bacterial lysate (or his purification elutions in the case of Par-3 PDZ1-APM or Par-3 PDZ1-PDZ3 as these proteins contain COOH-terminal his tags) containing MBP- or GST-fusion protein for 30 minutes at 4° C and then washed with wash buffer three times (20 mM HEPES, pH 7.5, 100 mM NaCl, 5 mM MgCl₂, 0.5% Tween 20, and 1 mM DTT). Par-complex was then added to a concentration of 0.5 μ M and incubated for 10 minutes at room temperature. In the case

where ATP is present, ATP was used at a final concentration of 200 μ M in all buffers throughout the pull down experiment and binding reactions were carried out for 30 minutes at room temperature. Finally, beads were washed two times briefly to remove unbound Par-complex and beads were resuspended in loading dye. Samples were analyzed by SDS-Page and stained by Coomassie as well as Western Blot using α -aPKC (Mouse α -PKC ζ H-1 Santa Cruz Biotech sc-17781) and rat α -Par-6.

Supernatant depletion interaction assay

Amylose resin was loaded with bacterial lysate containing MBP – Par-3 PDZ1 – APM for 30 minutes at 4° C and then washed with wash buffer (20 mM HEPES, pH 7.5, 100 mM NaCl, 5 mM MgCl₂, 200 μ M ATP, 0.5% Tween 20, and 1 mM DTT). 2-fold serial dilutions of beads were prepared from 20 μ L to 0.625 μ L in a total volume of 200 μ L. Par-complex was added to a final concentration of 40 nM diluted in wash buffer. After incubation for 30 minutes, beads were collected by centrifugation and an aliquot of supernatant was diluted in loading dye for western blot analysis using α -aPKC (Mouse α -PKC ζ H-1 Santa Cruz Biotech sc-17781) and rat α -Par-6. The concentration of protein loaded on the beads was verified by SDS-Page using a standard curve generated with known concentrations of BSA.

Drosophila Neuroblast Immunofluorescence

Flies were allowed to lay in vials for 24 hours at room temperature, after which the flies were removed, and the vial was moved to 30°C. During wandering third instar larval stage (5-6 days later), larvae were dissected within 20 minutes into Schneider's Insect Medium (Sigma, S0146). Brains were fixed using 4% PFA in PBS for 20 minutes followed by 3 washes in PBST (1xPBS + 0.3% Triton-X 100, Sigma-Aldrich). Note that during all fixing, blocking, and washing steps, brains were kept moving on a nutator. At this stage brains could be kept for up to 3 days nutating at 4°C in PBST or washed an additional 20 minutes in PBST before blocking and staining. Brains were blocked for 30 minutes in PBSBT (PBST + 1% BSA, Fisher Scientific). Incubation in primary antibodies occurred overnight at 4°C. Primary antibodies: Rat α -Mira (1:500; Abcam, ab197788), Mouse α -PKC ζ H-1(1:1,000; Santa Cruz Biotech sc-17781), Rabbit α -PKC ζ C-20 (1:1,000; Santa Cruz Biotech sc-216), Rabbit α -HA C29F4(1:1,000; Cell Signaling Technologies, 3724), Mouse α -HA (1:500; Covance, MMS-101P), and Guinea Pig α -Baz(1:2,000; gift from C.Doe). Brains were then washed quickly followed by 3x15 minutes washes in PBSBT. Incubation in secondary antibodies occurred at room temperature protected from light for 2 hours followed by a quick wash and 3x15 minutes washes in PBST. Secondary antibodies used were from Jackson ImmunoResearch Laboratories, Inc.: Dk α -Rt Cy3 (712-165-153; 1:500), Dk α -Rb 647 (711-605-152; 1:500), Dk α -Ms 488 (715-545-151), Dk α -Gp 405 (706-475-148; 1:500). Brains were stored in SlowFade Diamond with DAPI (Invitrogen, S36964) for at least 24 hours before imaging. Brains were imaged using a Leica TCS SPE upright confocal microscope using an ACS APO 40x 1.15 NA Oil CS objective.

Drosophila Neuroblast MARCM Clones

To generate *Drosophila* neuroblast MARCM clones, FRT-G13, *aPKC*^{K06403}/CyO Virgin flies were crossed to ;3xHA-aPKC V606A male flies. The resulting non-Cyo male progeny were crossed to elav-Gal4, UAS-mCD8:GFP, hs:flp; FRT-G13, tubPGal80 Virgins and allowed to lay for 24 hours at room temperature. The vials were then allowed to stay at room temperature for an additional 24 hours at which time they were heat-shocked @37°C for 90 minutes. This was followed by a possible second 90 minute heat-shock within 18 hours. Vials were raised at 18°C or room temperature until wandering third instar stage when they were dissected and stained as described above with the following antibodies: Primary antibodies: Rat α -Mira (1:500; Abcam, ab197788), Rabbit α -HA C29F4(1:1,000; Cell Signaling Technologies, 3724) or Mouse α -HA (1:500; Covance, MMS-101P), and Chicken α -GFP (1:500; Abcam, ab13970). Secondary antibodies: Dk α -Rt Cy3 (712-165-153; 1:500), Dk α -Rb 647 (711-605-152; 1:500) or Dk α -Ms 647 (715-605-151; 1:500), and Dk α -Ck 488 (703-545-155). Brains were imaged using a Leica TCS SPE upright confocal microscope using an ACS APO 40x 1.15 NA Oil CS objective or an Olympus Fluoview FV1000 upright confocal microscope using a PlanApo N 60x 1.42 NA Oil objective.

Quantification and statistical analysis

Quantification of equilibrium dissociation constants

The equilibrium dissociation constant for Par-3 PDZ1-APM binding to Par-6/aPKC was calculated by measuring both Par-6 and aPKC western signals from the

supernatant of solutions containing increasing concentrations of amylose resin-bound MBP-Par-3 PDZ1-APM and fitting to the following equation:

$$f_b = \text{free} + (\text{bound} - \text{free}) * [\text{Par-3 PDZ1-APM}] / ([\text{Par-3 PDZ1-APM}] + K_d)$$

“ f_b ” was calculated from the experimentally measured Par-6 and aPKC western signals using the equation $1 - W_x/W_0$ where W_x is the western signal at Par-3 concentration x and W_0 is the western signal in the absence of Par-3

“free” and “bound” are the fraction of Par-6/aPKC bound when saturated and in the absence of Par-3, respectively. These parameters were allowed to float

K_d is the equilibrium dissociation constant.

Fitting and calculation of 95% confidence intervals were done using the LMFIT python package.

Drosophila Neuroblast Quantification

All images were analyzed using Fiji. For quantification of apical cortical to cytoplasmic signal intensity ratios, corresponding signals were measured from an intensity profile averaged from 10 pixels across the apical portion of the cell parallel with the polarity axis in a central optical section. The apical value was taken as the highest peak data point corresponding with the apical domain of the cell, the cytoplasmic value was an average of 20 data points that were a distance of 10 points away from the apical value.

Bridge to Chapter IV

In this chapter I have discovered a novel molecular interaction between Par-3's PDZ2 domain and a PDZ binding motif (PBM) at the COOH-terminus of aPKC. Using purified full-length Par-complex and Par-3, I show that this interaction is both necessary and sufficient for the persistent association between Par-3 and the Par-complex (Figure 13). Additionally, this interaction is not regulated by phosphorylation of Par-3. As such, this work has challenged the current models regarding the apical polarization of aPKC which is foundational to our understanding of animal cell polarity. In the next chapter I will give a brief summary of my findings and address a number of important questions that my research has led to.

CHAPTER IV

FUTURE CONSIDERATIONS AND CONCLUDING REMARKS

SUMMARY

Cells polarize for a variety of diverse processes, and a central component of many polarized cells is the protein kinase atypical Protein Kinase C (aPKC), whose activity and localization are fundamental in establishing and maintaining discrete cortical domains. The regulation of aPKC activity must be tightly coupled to its localization such that it is only active while localized to the apical cortical domain, where it can exert its enzymatic activity to maintain the integrity of the apical domain through phosphorylation mediated cortical displacement. While numerous protein-protein interactions are required for regulation of aPKC, none are sufficient to polarize aPKC's activity. As such, understanding how aPKC interacts with its regulators is paramount to determining the molecular mechanisms that govern aPKC polarization.

The work presented here focused on the molecular interactions between Par-3 and the Par-complex that lead to regulation and complex formation. The first part of my work focused on the interaction between the Par-3 APM and the aPKC kinase domain. Contrary to previous reports, I show that this interaction, like all enzyme/substrate interactions is transient and as such does not support a viable mechanism for a stable inhibited complex. The second part of this work identified a novel, persistent interaction between the Par-complex and Par-3 that is independent of Par-3 phosphorylation, while showing that none of the other proposed interactions appear to be required for a stable persistent interaction (Figure 14). Furthermore, for the first time, we have identified an

interaction between the Par-complex and Par-3 that abolishes aPKC's apical polarization through a single point mutation in the aPKC PBM. While this work has greatly improved our understanding of how Par-3 interacts with the Par-complex, a number of important questions still remain unanswered for us to understand the molecular mechanisms that underly aPKC's regulation and apical polarization. In the following section I will discuss some of these open questions and how answers to these questions will further our understanding of animal cell polarity.

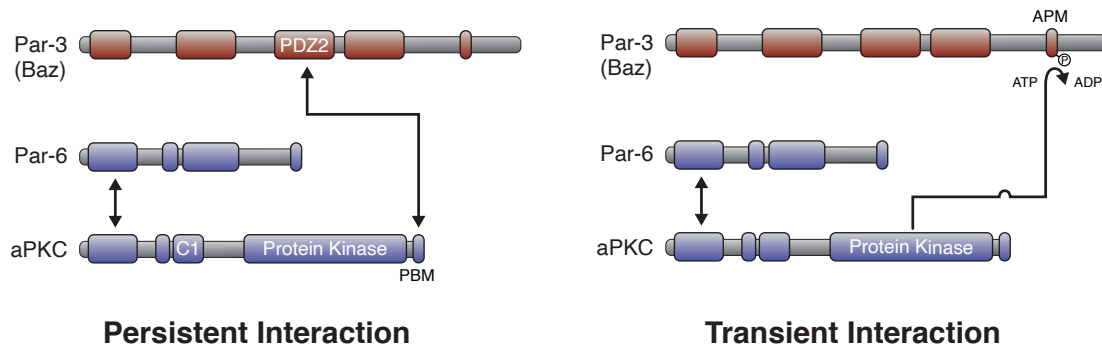

Figure 14: Par mediated animal cell polarization. Par-3 interacts with the Par-complex through a persistent PDZ2-PBM interaction and a transient kinase-substrate interaction.

FUTURE CONSIDERATIONS

Over two decades have passed since the initial discovery that aPKC interacts with Par-3. While numerous interactions have been proposed to be required for complex assembly, controversy has surrounded nearly every one of these interactions. Furthermore, none of the previously identified interactions have been shown to be required in a cellular context. With a much clearer picture of how Par-3 interacts with the Par-complex, we are poised to address a number of important outstanding questions:

Does Par-3 regulate Par-complex activity (positively or negatively)? How is the interaction between Par-3 and the Par-complex regulated? What is the role of Par-3 phosphorylation? Why are both Par-3 and Cdc42 required for Par-complex polarization while neither are sufficient?

The role of Par-3 as a regulator of aPKC activity

Does Par-3 inhibit aPKC's kinase activity? The simple answer is, yes. However, all substrates can inhibit kinase activity *in vitro* given the right conditions. The more relevant question to ask is: Does the inhibition of aPKC by Par-3 have a functional consequence? The easiest way to test this *in vivo* would be to remove the inhibitor and determine if the function of the kinase is affected. However, Par-3 is required for aPKC's apical polarization, and as such, aPKC is lost to the cytoplasm making this a little more difficult to assess directly. However, a number of studies have been able to indirectly address this question *in vivo*. For example, in epithelia over-expressing the phosphodead Par-3 mutant (S980A), while the apical membrane is deformed, aPKC still polarizes Lgl (Morais-de-Sá et al., 2010). If Par-3 were acting as an inhibitor, Lgl would be cortical. In the *Drosophila* central brain, over proliferation of neuroblasts is observed when fate determinants are cleared from the entire cortex leading to symmetric divisions. Over expression of an aPKC mutant that is targeted to the entire cortex leads to significant over proliferation. While not as dramatic, over-expression of Par-3 in an otherwise WT background also leads to an increase in neuroblast numbers, further arguing against the Par-3 inhibitor model (Wirtz-Peitz et al., 2008).

More recently, Rodriguez et al showed that Par-3 can inhibit aPKC's kinase activity using an *in vivo* reporter assay (Rodriguez et al., 2017). While this experiment supports the *in vitro* inhibitor studies, it does not reconcile the role Par-3 has, if any, in regulating aPKC activity. Therefore, it is still unclear if Par-3 inhibits aPKC activity.

I have clearly demonstrated that the Par-3 APM is phosphorylated by the kinase domain of aPKC, nothing else needs to happen, and that it can competitively inhibit kinase activity as do all substrates. If Par-3 inhibition has a functional consequence, it is possible that this could occur through an alternative mechanism. I identified a novel Par-3/aPKC interaction in chapter III between the PBM of aPKC and the PDZ2 of Par-3. Does this new interaction play a role in aPKC inhibition? Maybe this interaction activates aPKC. It is certainly plausible that this interaction serves no role in regulating aPKC activity. Alternatively, the binding between Par-3 and aPKC outside of the APM may allow the APM to bind to the kinase domain better, or it may make the phosphorylated APM bind with higher affinity, blocking access to other substrates. In the future we will be assessing the role the PDZ2 may play in regulating aPKC activity both *in vitro* and more importantly, *in vivo*.

Cdc42 dissociates Par-3 from the Par-complex

The dual requirement of Par-3 and Cdc42 on Par-complex polarization is controversial and numerous mechanisms have been hypothesized. However, there is little consistency among models and conflicting data has made it difficult to agree upon one central model. Recently, genetic studies suggest that Cdc42 and Par-3 are mutually

exclusive leading to two functionally distinct states: a Par-3/Par-6/aPKC inhibited complex and a Cdc42/Par-6/aPKC active complex (Rodriguez et al., 2017).

We have been investigating the mutual exclusivity of Par-3 and Cdc42. While *in vivo* experiments have previously shown the two to be exclusive, early biochemical data showed that aPKC, Par-6, Par-3, and Cdc42 could form a quaternary complex (Joberty et al., 2000). Whether or not these two observations are consistent is unclear. Cdc42 binds to the semi-crib domain of Par-6, while Par-3 binds to the PBM of aPKC and as such cannot compete for the same binding site. However, mutual exclusion could occur if the semi-crib and PBM were in close proximity to each other putting steric constraints on simultaneous binding. If this were the case, then a quaternary complex could not be formed *in vitro*. One explanation for the observed quaternary complex formation observed *in vitro*, is that this experiment was not done in the presence of ATP and as such, binding of the Par-3 APM to the aPKC kinase domain could remain bound as shown in chapter III.

An alternative hypothesis is that Par-3 and Cdc42 compete for aPKC's PBM where Cdc42 binding to the semi-crib increases the affinity of the Par-6 PDZ domain for the aPKC PBM. In this model a quaternary complex could most certainly be observed *in vitro*, depending on the experimental conditions of the assay, while *in vivo* observations may not be able to capture this quaternary complex formation. We are taking a systematic approach to 1) determine if the Par-complex switches from a Par-3 bound state and a Cdc42 bound state, and 2) to identify the mechanism that leads to these observed mutually exclusive states. Preliminary biochemical studies show that Cdc42 can indeed inhibit the binding interaction between Par-3 and the Par-complex, with the

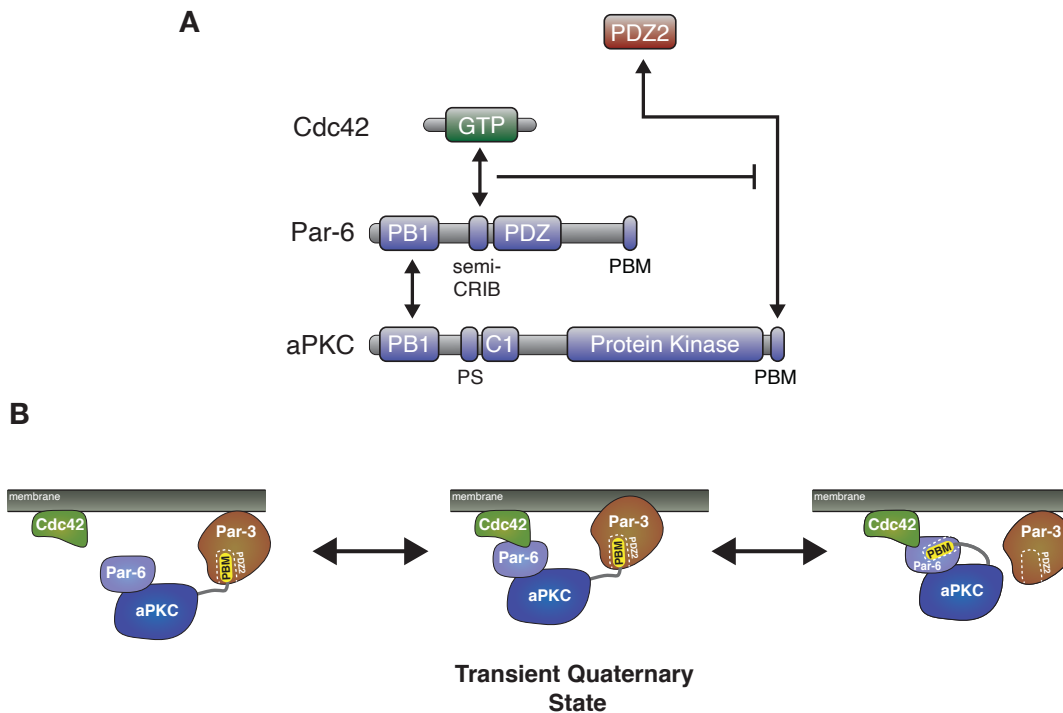

Figure 15: Cdc42 inhibits the interaction between the Par-complex and the Par-3 PDZ2. (A) Cdc42 is sufficient to inhibit the interaction between Par-3 PDZ2 and the Par-complex (B) Indirect competition model where the aPKC PBM competes for Cdc42 bound Par-6 PDZ domain and Par-3 PDZ2.

reverse being true as well. Furthermore, active Cdc42 is sufficient to dissociate the Par-3 PDZ2 from the Par-complex (Figure 15).

While these preliminary experiments clearly show that Par-3 and Cdc42 can inhibit each other's binding, it is still unclear whether this is through indirect competition for the aPKC PBM, or through direct competition resulting from steric constraints. Future studies will take a structure/function approach to discern these two models by first asking what minimal components of the Par-complex are required for Cdc42 mediated inhibition of Par-3 from the Par-complex. For example, for this switching to occur, we

know that the aPKC PBM and Par-3 PDZ2 domains are required. The semi-crib domain is also required as this is the binding site for Cdc42. Currently we are assessing the importance of the Par-6 PDZ through a mutation that disrupts its ability to bind PBM's while maintaining a functional semi-crib. If exclusion still occurs in the context of this mutant, then this would argue against the indirect competition model. Regardless of the exact mechanism, the observation that Cdc42 is sufficient to dissociate Par-3 from the Par-complex is an exciting finding and, to the best of our knowledge, the first instance where the Par-3/Par-complex interaction is regulated.

The role of Par-3 phosphorylation in animal cell polarity

By far the most well characterized function of aPKC's kinase activity is to restrict the localization of substrates like Miranda (Atwood and Prehoda, 2009), Numb (Wirtz-Peitz et al., 2008), Lgl (Bailey and Prehoda, 2015; Betschinger et al., 2003), Par-1 (Hurov et al., 2004), and Par-2 (Hao et al., 2006) from localizing to the apical domain through phosphorylation mediated cortical displacement. However, there is a smaller yet growing list of substrates whose activity is dependent on aPKC phosphorylation. For example, the MAGUK protein, Dlg is required for proper alignment of the mitotic spindles during neuroblast asymmetric cell division (Siegrist and Doe, 2005). Dlg's guanylate kinase (GK) domain is auto-inhibited by its SH3 domain and access of the GK domain is required for its interactions with downstream spindle orientation factors like Guckholder (Johnston et al., 2009; Marcette et al., 2009). Recently it was found that aPKC is

required for this interaction, where phosphorylation of Dlg's SH3 domain by aPKC relieves auto-inhibition allowing it to bind Guckholder (Golub et al., 2017).

Par-3 is another example of an aPKC substrate whose phosphorylation does not ascribe to the phosphorylation mediated cortical displacement model, at least in neuroblasts and the *C. elegans* embryo. Interestingly, in epithelia, phosphorylation appears to signal its localization to adherens junctions where it interacts with the cadherin complex. However, the role of phosphorylation appears to be important for interacting with members of the cadherin complex and not for cortical displacement as the phosphomimetic Par-3 still localizes to the membrane in neuroblasts (Morais-de-Sá et al., 2010). While previous mechanisms have described Par-3 phosphorylation as a regulatory mechanism that is required for the dissociation from the Par-complex, my data clearly shows that while phosphorylation inhibits the enzyme/substrate interactions, phosphorylation alone does not dissociate Par-3 from the fully reconstituted Par-complex.

If phosphorylation is not a regulatory mechanism required for the dissociation of the complex, then what is the role of Par-3 phosphorylation. Previous data has shown that constitutively active Cdc42 is sufficient to drive aPKC to the entire cortex, while Par-3 is still apically localized (Atwood et al., 2007). One hypothesis is that phosphorylation of Par-3 is required for activating Cdc42, possibly through the recruitment of a GEF. This mechanism would set up a strong positive feedback loop where initially, the Par-complex is recruited to the apical domain by Par-3, and that phosphorylation increases the local concentrations of a Cdc42 GEF, thus increasing the local concentration of activated Cdc42.

CONCLUDING REMARKS

The work presented in this dissertation has contributed significantly to our understanding of the molecular interactions between three key components of the apical polarity network. My work strongly supports a clear picture of how these three proteins interact. aPKC phosphorylates Par-3 just like it phosphorylates all substrates: binding to the catalytic site followed by phosphate transfer and release. Additionally, there is no genetic evidence to suggest a functional consequence to Par-3 inhibition of catalytic activity. Furthermore, I show that phosphorylation alone is not sufficient to inhibit the Par-3/Par-complex interaction in a fully reconstituted system. While further investigating the five previously reported molecular interactions between Par-3 and the Par-complex I uncovered a novel interaction between the PDZ2 domain of Par-3 and the COOH-terminal PBM of aPKC that is not only biochemically required but also required for the polarization of aPKC in the *Drosophila* neuroblast. Additionally, while we cannot rule out the possibility that none of the previously reported interactions are not contributing to these interactions, the PDZ2:PBM interaction is the only interaction that is required for complex formation. Now that we understand how Par-3 and the Par-complex interact, we can investigate how these interactions are regulated. Future work will seek to understand the role of Par-3 phosphorylation and what regulates the Par-3/Par-complex interaction focusing on the very interesting dual requirement of Par-3 and Cdc42 on aPKC apical polarization.

APPENDIX

APPENDIX A: SUPPLEMENTAL MATERIALS FOR CHAPTER III

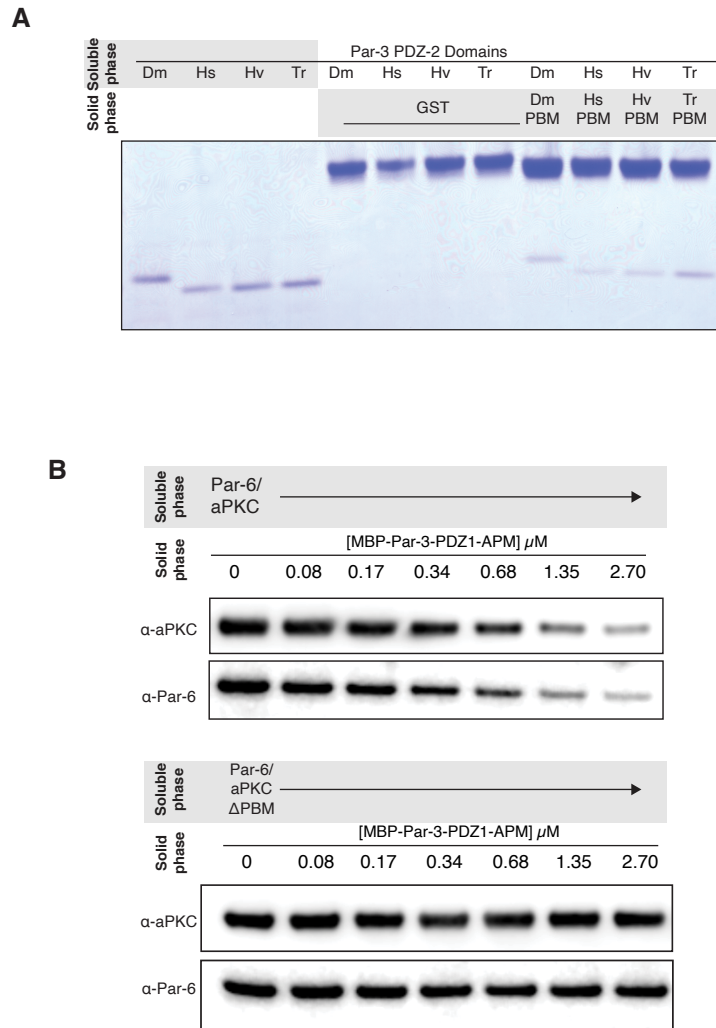

Figure S1: Binding of Par-3 PDZ2 and aPKC PBM orthologues from diverse metazoan organisms and quantitative analysis by supernatant depletion. Related to Figure 3. (A) Solid phase (glutathione resin) bound to Glutathione-S-Transferase (GST) fused aPKC PBM's with Par-3 PDZ2 domains from the indicated organisms (Dm = *Drosophila melanogaster*; Hs = *Homo sapiens*; Hv = *Hydra vulgaris*; Tr = *Trichoplax sp H2*). Shaded region indicates fraction applied to gel (soluble phase or solid phase components after mixing with soluble phase components and washing). (B) Equilibrium binding of Par-3 PDZ1-APM to Par-6/aPKC (top panel) or Par-6/aPKC Δ PBM (bottom panel). Westerns show aPKC and Par-6 remaining in the supernatant after incubation with solid phase (amylose resin) bound with the indicated concentration of Maltose Binding Protein (MBP) fused Par-3 PDZ1-APM. Shaded region indicates fraction applied to gel after mixing and incubation.

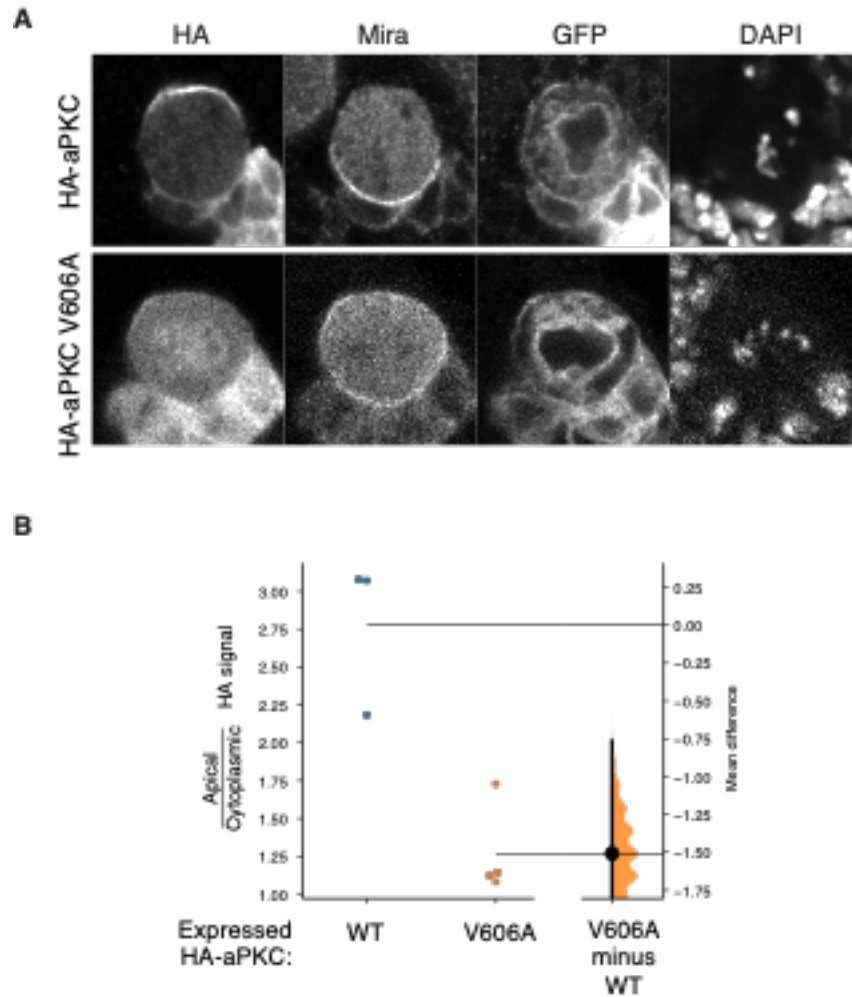

Figure S2 Recruitment of aPKC to the apical cortex of metaphase *Drosophila* neuroblasts depends on its PDZ Binding Motif. Related to Figure 4. (A) Protein localization in metaphase aPKC^{K06403} neuroblasts expressing WT or V606A aPKC. The localization of HA-tagged WT or V606A aPKC, expressed using Worniu-GAL4/Uas, is shown with the basal marker Miranda, GFP-mCD8 (marks aPKC^{K06403} neuroblasts), and DNA (DAPI). (B) Gardner-Altman estimation plot of effect of the aPKC V606A mutation on aPKC cortical localization. Apical cortical to cytoplasmic signal anti-HA intensities are shown for individual aPKC^{K06403} metaphase neuroblasts expressing either HA-WT or HA-V606A aPKC and for the anti-aPKC (includes endogenous and transgenically expressed). Statistics: Bootstrap 95% confidence interval (Bar in “V606A minus WT” column)

REFERENCES CITED

- Achilleos, A., Wehman, A.M., and Nance, J. (2010). P AR-3 mediates the initial clustering and apical localization of junction and polarity proteins during *C. elegans* intestinal epithelial cell polarization. *Development* *137*, 1833–1842.
- Apodaca, G., and Gallo, L.I. (2013). E pithelial Polarity. *Colloquium Series on Building Blocks of the Cell: Cell Structure and Function 1*, 1–115.
- Atwood, S.X., and Prehoda, K.E. (2009). a PKC phosphorylates Miranda to polarize fate determinants during neuroblast asymmetric cell division. *Curr. Biol.* *19*, 723–729.
- Atwood, S.X., Chabu, C., Penkert, R.R., Doe, C.Q., and Prehoda, K.E. (2007). Cdc 42 acts downstream of Bazooka to regulate neuroblast polarity through Par-6/aPKC. *J Cell Sci* *120*, 3200–3206.
- Bailey, M.J., and Prehoda, K.E. (2015). E stablishment of Par-Polarized Cortical Domains via Phosphoregulated Membrane Motifs. *Dev. Cell* *35*, 199–210.
- Bar-Even, A., Noor, E., Savir, Y., Liebermeister, W., Davidi, D., Tawfik, D.S., and Milo, R. (2011). T he moderately efficient enzyme: evolutionary and physicochemical trends shaping enzyme parameters. *Biochemistry* *50*, 4402–4410.
- Bayliss, R., Haq, T., and Yeoh, S. (2015). T he Ys and wherefores of protein kinase autoinhibition. *Biochimica et Biophysica Acta (BBA) - Proteins and Proteomics* *1854*, 1586–1594.
- Betschinger, J., Mechtler, K., and Knoblich, J.A. (2003). T he Par complex directs asymmetric cell division by phosphorylating the cytoskeletal protein Lgl. *Nature* *422*, 326–330.
- Chant, J. (1999). Ce ll Polarity in Yeast. *Annual Review of Cell and Developmental Biology* *15*, 365–391.
- Cherfils, J., and Zeghouf, M. (2013). Re gulation of Small GTPases by GEFs, GAPs, and GDIs. *Physiological Reviews* *93*, 269–309.
- Colongonzalez, F., and Kazanietz, M. (2006). C1 dom ains exposed: From diacylglycerol binding to protein–protein interactions. *Biochimica et Biophysica Acta (BBA) - Molecular and Cell Biology of Lipids* *1761*, 827–837.
- Dickinson, D.J., Schwager, F., Pintard, L., Gotta, M., and Goldstein, B. (2017). A Single-Cell Biochemistry Approach Reveals PAR Complex Dynamics during Cell Polarization. *Developmental Cell* *42*, 416-434.e11.

- Dutil, E.M., and Newton, A.C. (2000). Dual Role of Pseudosubstrate in the Coordinated Regulation of Protein Kinase C by Phosphorylation and Diacylglycerol. *J. Biol. Chem.* *275*, 10697–10701.
- Endicott, J.A., Noble, M.E.M., and Johnson, L.N. (2012). The Structural Basis for Control of Eukaryotic Protein Kinases. *Annual Review of Biochemistry* *81*, 587–613.
- Etienne-Manneville, S., and Hall, A. (2002). Cell polarity: Par6, aPKC and cytoskeletal crosstalk. *Current Opinion in Cell Biology* *15*, 67–72.
- Fahey, B., and Degnan, B.M. (2010). Origin of animal epithelia: insights from the sponge genome. *Evol. Dev.* *12*, 601–617.
- Feng, W., Wu, H., Chan, L.-N., and Zhang, M. (2007). The Par-3 NTD adopts a PB1-like structure required for Par-3 oligomerization and membrane localization. *The EMBO Journal* *26*, 2786–2796.
- Fersht, A. (1999). *Structure and mechanism in protein science: a guide to enzyme catalysis and protein folding* (New York: W.H. Freeman).
- Gao, T., and Newton, A.C. (2006). Invariant Leu Preceding Turn Motif Phosphorylation Site Controls the Interaction of Protein Kinase C with Hsp70. *J. Biol. Chem.* *281*, 32461–32468.
- Giorgione, J.R., Lin, J.-H., McCammon, J.A., and Newton, A.C. (2006). Increased Membrane Affinity of the C1 Domain of Protein Kinase C Compensates for the Lack of Involvement of Its C2 Domain in Membrane Recruitment. *Journal of Biological Chemistry* *281*, 1660–1669.
- Goldstein, B., and Macara, I.G. (2007). The PAR Proteins: Fundamental Players in Animal Cell Polarization. *Developmental Cell* *13*, 609–622.
- Golub, O., Wee, B., Newman, R.A., Paterson, N.M., and Prehoda, K.E. (2017). Activation of Discs large by aPKC aligns the mitotic spindle to the polarity axis during asymmetric cell division. *ELife* *6*, e32137.
- Graybill, C., Wee, B., Atwood, S.X., and Prehoda, K.E. (2012). Partitioning-defective Protein 6 (Par-6) Activates Atypical Protein Kinase C (aPKC) by Pseudosubstrate Displacement. *Journal of Biological Chemistry* *287*, 21003–21011.
- Grifoni, D., Garoia, F., Bellosta, P., Parisi, F., De Biase, D., Collina, G., Strand, D., Cavicchi, S., and Pession, A. (2007). aPKCzeta cortical loading is associated with Lgl cytoplasmic release and tumor growth in *Drosophila* and human epithelia. *Oncogene* *26*, 5960–5965.
- Hao, Y., Boyd, L., and Seydoux, G. (2006). Stabilization of Cell Polarity by the C. elegans RING Protein PAR-2. *Dev Cell* *10*, 199–208.

- Harris, T.J.C., and Peifer, M. (2005). The positioning and segregation of apical cues during epithelial polarity establishment in *Drosophila*. *J Cell Biol* *170*, 813–823.
- Hillier, B.J., Christopherson, K.S., Prehoda, K.E., Bredt, D.S., and Lim, W.A. (1999). Unexpected Modes of PDZ Domain Scaffolding Revealed by Structure of nNOS-Syntrophin Complex. *284*, 5.
- Hirano, Y., Yoshinaga, S., Takeya, R., Suzuki, N.N., Horiuchi, M., Kohjima, M., Sumimoto, H., and Inagaki, F. (2005). Structure of a Cell Polarity Regulator, a Complex between Atypical PKC and Par6 PB1 Domains. *J. Biol. Chem.* *280*, 9653–9661.
- Holly, R.W., and Prehoda, K.E. (2019). Phosphorylation of Par-3 by Atypical Protein Kinase C and Competition between Its Substrates. *Dev. Cell* *49*, 678–679.
- Horikoshi, Y., Suzuki, A., Yamanaka, T., Sasaki, K., Mizuno, K., Sawada, H., Yonemura, S., and Ohno, S. (2009). Interaction between PAR-3 and the aPKC–PAR-6 complex is indispensable for apical domain development of epithelial cells. *J Cell Sci* *122*, 1595–1606.
- Hurov, J.B., Watkins, J.L., and Piwnica-Worms, H. (2004). Atypical PKC phosphorylates PAR-1 kinases to regulate localization and activity. *Current Biology* *14*, 736–741.
- Hutterer, A., Betschinger, J., Petronczki, M., and Knoblich, J.A. (2003). Sequential Roles of Cdc42, Par-6, {aPKC,} and Lgl in the Establishment of Epithelial Polarity during *Drosophila* Embryogenesis. *Developmental Cell* *6*.
- Izumi, Y., Hirose, T., Tamai, Y., Hirai, S., Nagashima, Y., Fujimoto, T., Tabuse, Y., Kempfues, K.J., and Ohno, S. (1998). An atypical PKC directly associates and colocalizes at the epithelial tight junction with ASIP, a mammalian homologue of *Caenorhabditis elegans* polarity protein PAR-3. *J. Cell Biol.* *143*, 95–106.
- Joberty, G., Petersen, C., Gao, L., and Macara, I.G. (2000). The cell-polarity protein Par6 links Par3 and atypical protein kinase C to Cdc42. *Nat. Cell Biol.* *2*, 531–539.
- Johnson, J.E., Giorgione, J., and Newton, A.C. (2000). The C1 and C2 Domains of Protein Kinase C Are Independent Membrane Targeting Modules, with Specificity for Phosphatidylserine Conferred by the C1 Domain. *Biochemistry* *39*, 11360–11369.
- Johnston, C.A., Hirono, K., Prehoda, K.E., and Doe, C.Q. (2009). Identification of an Aurora-A/PinsLINKER/ Dlg Spindle Orientation Pathway using Induced Cell Polarity in S2 Cells. *Cell* *138*, 1150–1163.
- Jura, N., Zhang, X., Endres, N.F., Seeliger, M.A., Schindler, T., and Kuriyan, J. (2011). Catalytic Control in the EGF Receptor and Its Connection to General Kinase Regulatory Mechanisms. *Molecular Cell* *42*, 9–22.
- Kempfues, K.J., Priess, J.R., Morton, D.G., and Cheng, N. (1988). Identification of genes required for cytoplasmic localization in early *C. elegans* embryos. *Cell* *52*, 311–320.

- Knoblich, J.A. (2010). Asymmetric cell division: recent developments and their implications for tumour biology. *Nat. Rev. Mol. Cell Biol.* *11*, 849–860.
- Lang, C.F., and Munro, E. (2017). The PAR proteins: from molecular circuits to dynamic self-stabilizing cell polarity. *Development* *144*, 3405–3416.
- Lee, C.-Y., Robinson, K.J., and Doe, C.Q. (2006). Lgl, Pins and aPKC regulate neuroblast self-renewal versus differentiation. *Nature* *439*, 594–598.
- Leibfried, A., Müller, S., and Ephrussi, A. (2013). A Cdc42-regulated actin cytoskeleton mediates *Drosophila* oocyte polarization. *Development* *140*, 362–371.
- Li, B., Kim, H., Beers, M., and Kemphues, K. (2010a). Different domains of *C. elegans* PAR-3 are required at different times in development. *Dev. Biol.* *344*, 745–757.
- Li, J., Kim, H., Aceto, D.G., Hung, J., Aono, S., and Kemphues, K.J. (2010b). Binding to PKC-3, but not to PAR-3 or to a conventional PDZ domain ligand, is required for PAR-6 function in *C. elegans*. *Dev. Biol.* *340*, 88–98.
- Lin, D., Edwards, A.S., Fawcett, J.P., Mbamalu, G., Scott, J.D., and Pawson, T. (2000). A mammalian PAR-3–PAR-6 complex implicated in Cdc42/Rac1 and aPKC signalling and cell polarity. *2*, 540–547.
- Marcette, J., Hood, I.V., Johnston, C.A., Doe, C.Q., and Prehoda, K.E. (2009). Allosteric Control of Regulated Scaffolding in Membrane-Associated Guanylate Kinases. *Biochemistry* *48*, 10014–10019.
- McCaffrey, L.M., and Macara, I.G. (2009). The Par3/aPKC interaction is essential for end bud remodeling and progenitor differentiation during mammary gland morphogenesis. *Genes Dev.* *23*, 1450–1460.
- McKinley, R.F.A., Yu, C.G., and Harris, T.J.C. (2012). Assembly of Bazooka polarity landmarks through a multifaceted membrane-association mechanism. *J. Cell. Sci.* *125*, 1177–1190.
- Morais-de-Sá, E., Mirouse, V., and St Johnston, D. (2010). aPKC Phosphorylation of Bazooka Defines the Apical/Lateral Border in *Drosophila* Epithelial Cells. *Cell* *141*, 509–523.
- Nagai-Tamai, Y., Mizuno, K., Hirose, T., Suzuki, A., and Ohno, S. (2002). Regulated protein–protein interaction between aPKC and PAR-3 plays an essential role in the polarization of epithelial cells. *Genes to Cells* *7*, 1161–1171.
- Newton, A.C. (1997). Regulation of protein kinase C. *Current Opinion in Cell Biology* *9*, 161–167.
- Ngok, S.P., Lin, W.-H., and Anastasiadis, P.Z. (2014). Establishment of epithelial polarity – GEF who’s minding the GAP? *J Cell Sci* *127*, 3205–3215.

- Noble, M.E.M., Endicott, J.A., and Johnson, L.N. (2004). Protein Kinase Inhibitors: Insights into Drug Design from Structure. *Science* *303*, 1800–1805.
- Nolen, B., Taylor, S., and Ghosh, G. (2004). Regulation of Protein Kinases: Controlling Activity through Activation Segment Conformation. *Molecular Cell* *15*, 661–675.
- Nunes de Almeida, F., Walther, R.F., Pressé, M.T., Vlassaks, E., and Pichaud, F. (2019). Cdc42 defines apical identity and regulates epithelial morphogenesis by promoting apical recruitment of Par6-aPKC and Crumbs. *Development* *146*, dev175497.
- Oon, C.H., and Prehoda, K.E. (2019). Asymmetric recruitment and actin-dependent cortical flows drive the neuroblast polarity cycle. *Elife* *8*.
- Orr, J.W., Keranen, L.M., and Newton, a. C. (1992). Reversible exposure of the pseudosubstrate domain of protein kinase C by phosphatidylserine and diacylglycerol. *Journal of Biological Chemistry* *267*, 15263–15266.
- Pearce, L.R., Komander, D., and Alessi, D.R. (2010). The nuts and bolts of AGC protein kinases. *Nat Rev Mol Cell Biol* *11*, 9–22.
- Peterson, F.C., Penkert, R.R., Volkman, B.F., and Prehoda, K.E. (2004). Cdc42 regulates the Par-6 PDZ domain through an allosteric CRIB-PDZ transition. *Molecular Cell* *13*, 665–676.
- Pollard, T.D. (2010). A guide to simple and informative binding assays. *Mol. Biol. Cell* *21*, 4061–4067.
- Prehoda, K.E. (2009). Polarization of Drosophila Neuroblasts During Asymmetric Division. *Cold Spring Harbor Perspectives in Biology* *1*, a001388–a001388.
- Renschler, F.A., Bruekner, S.R., Salomon, P.L., Mukherjee, A., Kullmann, L., Schütz-Stoffregen, M.C., Henzler, C., Pawson, T., Krahn, M.P., and Wiesner, S. (2018). Structural basis for the interaction between the cell polarity proteins Par3 and Par6. *Sci Signal* *11*.
- Rodriguez, J., Peglion, F., Martin, J., Hubatsch, L., Reich, J., Hirani, N., Gubieda, A.G., Roffey, J., Fernandes, A.R., St Johnston, D., et al. (2017). aPKC Cycles between Functionally Distinct PAR Protein Assemblies to Drive Cell Polarity. *Dev. Cell* *42*, 400–415.e9.
- Rolls, M.M., Albertson, R., Shih, H.-P., Lee, C.-Y., and Doe, C.Q. (2003). Drosophila aPKC regulates cell polarity and cell proliferation in neuroblasts and epithelia. *J. Cell Biol.* *163*, 1089–1098.
- Siegrist, S.E., and Doe, C.Q. (2005). Microtubule-Induced Pins/Gai Cortical Polarity in Drosophila Neuroblasts. *Cell* *123*, 1323–1335.

- Smith, C.A., Lau, K.M., Rahmani, Z., Dho, S.E., Brothers, G., She, Y.M., Berry, D.M., Bonneil, E., Thibault, P., Schweisguth, F., et al. (2007). aPKC-mediated phosphorylation regulates asymmetric membrane localization of the cell fate determinant Numb. *EMBO J* 26, 468–480.
- Soriano, E.V., Ivanova, M.E., Fletcher, G., Riou, P., Knowles, P.P., Barnouin, K., Purkiss, A., Kosteletzky, B., Saiu, P., Linch, M., et al. (2016). aPKC Inhibition by Par3 CR3 Flanking Regions Controls Substrate Access and Underpins Apical-Junctional Polarization. *Dev. Cell* 38, 384–398.
- Suzuki, A. (2006). The PAR-aPKC system: lessons in polarity. *Journal of Cell Science* 119, 979–987.
- Tabuse, Y., Izumi, Y., Piano, F., Kemphues, K.J., Miwa, J., and Ohno, S. (1998). Atypical protein kinase C cooperates with PAR-3 to establish embryonic polarity in *Caenorhabditis elegans*. 8.
- Taylor, S.S., and Kornev, A.P. (2011). Protein kinases: evolution of dynamic regulatory proteins. *Trends Biochem. Sci.* 36, 65–77.
- Tepass, U. (2012). The Apical Polarity Protein Network in *Drosophila* Epithelial Cells: Regulation of Polarity, Junctions, Morphogenesis, Cell Growth, and Survival. 28, 655–685.
- Tepass, U., Tanentzapf, G., Ward, R., and Fehon, R. (2001). Epithelial Cell Polarity and Cell Junctions in *Drosophila*. *Annual Review of Genetics* 35, 747–784.
- Thompson, B.J., and McDonald, N.Q. (2019). Competitive Inhibition of aPKC by Par-3/Bazooka and Other Substrates. *Dev. Cell* 49, 680.
- Venkei, Z.G., and Yamashita, Y.M. (2018). Emerging mechanisms of asymmetric stem cell division. *J. Cell Biol.*
- Wang, C., Shang, Y., Yu, J., and Zhang, M. (2012). Substrate recognition mechanism of atypical protein kinase Cs revealed by the structure of PKC ζ in complex with a substrate peptide from Par-3. *Structure* 20, 791–801.
- Wang, S.-C., Low, T.Y.F., Nishimura, Y., Gole, L., Yu, W., and Motegi, F. (2017). Cortical forces and CDC-42 control clustering of PAR proteins for *Caenorhabditis elegans* embryonic polarization. *Nat. Cell Biol.* 19, 988–995.
- Wen, W., and Zhang, M. (2018). Protein Complex Assemblies in Epithelial Cell Polarity and Asymmetric Cell Division. *J. Mol. Biol.* 430, 3504–3520.
- Whitney, D.S., Peterson, F.C., and Volkman, B.F. (2011). A Conformational Switch in the CRIB-PDZ Module of Par-6. *Structure* 19, 1711–1722.

- Whitney, D.S., Peterson, F.C., Kittell, A.W., Egner, J.M., Prehoda, K.E., and Volkman, B.F. (2016). Binding of Crumbs to the Par-6 CRIB-PDZ Module Is Regulated by Cdc42. *Biochemistry* *55*, 1455–1461.
- Wirtz-Peitz, F., Nishimura, T., and Knoblich, J.A. (2008). Linking Cell Cycle to Asymmetric Division: Aurora-A Phosphorylates the Par Complex to Regulate Numb Localization. *Cell* *135*, 161–173.
- Wodarz, A., Ramrath, A., Kuchinke, U., and Knust, E. (1999). Bazooka provides an apical cue for Inscuteable localization in *Drosophila* neuroblasts. *Nature* *402*, 544–547.
- Wodarz, A., Ramrath, A., Grimm, A., and Knust, E. (2000). *Drosophila* atypical protein kinase C associates with Bazooka and controls polarity of epithelia and neuroblasts. *J. Cell Biol.* *150*, 1361–1374.
- Wu, H., Feng, W., Chen, J., Chan, L.-N., Huang, S., and Zhang, M. (2007). PDZ Domains of Par-3 as Potential Phosphoinositide Signaling Integrators. *Molecular Cell* *28*, 886–898.
- Yamanaka, T., Horikoshi, Y., Suzuki, A., Sugiyama, Y., Kitamura, K., Maniwa, R., Nagai, Y., Yamashita, A., Hirose, T., Ishikawa, H., et al. (2001). PAR-6 regulates aPKC activity in a novel way and mediates cell-cell contact-induced formation of the epithelial junctional complex. *Genes to Cells* *6*, 721–731.
- Yu, C.G., Tonikian, R., Felsensteiner, C., Jhingree, J.R., Desveaux, D., Sidhu, S.S., and Harris, T.J.C. (2014). Peptide binding properties of the three PDZ domains of Bazooka (*Drosophila* Par-3). *PLoS ONE* *9*, e86412.
- Zegers, M.M., and Friedl, P. (2014). Rho GTPases in collective cell migration. *Small GTPases* *5*.
- Zhang, H., Neimanis, S., Lopez-Garcia, L.A., Arencibia, J.M., Amon, S., Stroba, A., Zeuzem, S., Proschak, E., Stark, H., Bauer, A.F., et al. (2014). Molecular Mechanism of Regulation of the Atypical Protein Kinase C by N-terminal Domains and an Allosteric Small Compound. *Chemistry & Biology* *21*, 754–765.
- Zhou, Y., Johnson, J.L., Cerione, R.A., and Erickson, J.W. (2013). Prenylation and membrane localization of Cdc42 are essential for activation by DOCK7. *Biochemistry* *52*, 4354–4363.